



	AKUMULATORI I PUNJAČI	3		PRIBOR ZA VIŠENAMENSKI ALAT	206
	PRIBOR ZA AKUMULATORSKE ALATE	13		PRIBOR ZA TESTERE	216
	AKUMULATORSKE LAMPE I PRIBOR	36		PRIBOR ZA PNEUMATSKE ALATE	252
	PRIBOR ZA LASERSKE MERAČE	41		PRIBOR ZA FENOVE ZA VRUĆI VAZDUH	259
	PRIBOR ZA RUŠENJE I UDARNO BUŠENJE	44		PRIBOR ZA USISIVANJE	261
	PRIBOR ZA BUŠENJE	71		PRIBOR ZA ALATE ZA RAD NA OTVORENOM	287
	KRUNASTE TESTERE	89		PRIBOR ZA DRŽAČE ALATA I ZAŠITNA OPREMA	328
	PRIBOR ZA PRITEZANJE	107		KOFERI I TORBE	331
	PRIBOR ZA SEČENJE I BRUŠENJE	129		RUČNI ALATI	345
	PRIBOR ZA BRUŠENJE I POLIRANJE	178		OSTALO	356
	PRIBOR ZA PROFILISANJE I PORAVNAVANJE	191		PRIBOR ZA MEŠANJE	362

# AKUMULATORI I PUNJAČI



XGT je novi sistem alata, akumulatora i punjača.  
XGT je kombinacija inovativnog dizajna alata i visoko kapacitivnih akumulatora, kao odlično rešenje za veoma zahtevne poslove.

## OPTIMALNI SISTEM NAPAJANJA I OPTIMALNI SISTEM PUNJENJA

XGT serija ima integrisan sistem razmene podataka između akumulatora, alata i punjača za odlične radne performanse. Ovaj sistem takođe ima odličan sistem za punjenje akumulatora, koji uključuje dva ventilatora za hlađenje i digitalnu razmenu podataka između punjača i akumulatora za još bolje performanse punjenja.

Tehnologija akumulatora i dizajn motora daju optimalne rezultate u radu.

DIGITALNA KOMUNIKACIJA  
alat ◀▶ akumulator ◀▶ punjač



## IZDRŽLJIVOST

Ekstremno izdržljiv dizajn 40 V max Li-ion akumulatora.



4-LED indikator napunjenosti akumulatora

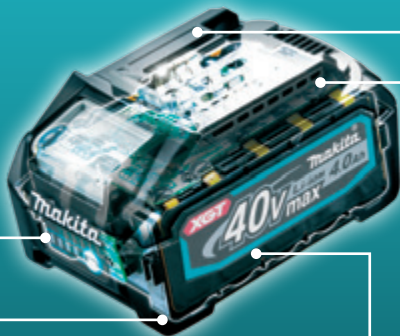

Sistem zaštite od udaraca, ima prazan prostor između kućišta i ćelija akumulatora, kao i držač ćelija a sve u cilju što bolje absorpcije udarca i padova aku.



1: izolacioni plašt  
2: film 3: vodo-otporni obruč  
Trostruka zaštita sprečava da dođe do kvara ćelije zbog ulaska voda i prašine.



Zaštita od kratkog spoja se zasniva na zidovima kućišta akumulatora, između konektora, koji sprečavaju prodiranje vode i prašine.



Novi sistem konektora na akumulatorima obezbeđuje sigurnu i čvrstu konekciju između akumulatora i alata.

## SISTEM ZA OPTIMALNO PUNJENJE

Pre nego što punjenje počne, važno je da se ohladi akumulator koji je zagrejan tokom upotrebe. Naš integrisani ventilator ubrzava rad tako što cirkuliše vazduh radi hlađenja akumulatora i na taj način optimizuje proces punjenja. Tokom punjenja punjač stalno komunicira sa čipom koji je integrisan u akumulatoru i aktivno kontroliše struju, napon i temperaturu kako bi obezbedio optimalan proces punjenja i čuva životni vek akumulatora.

### Optimalni sistem punjenja

Jako vazdušno hlađenje



### Standardni sistem punjenja

Prirodno razlivanje toplote

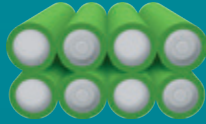

### Brzo punjenje



### Čekanje za punjenje

Nizak stepen samopražnjenja



### Optimalni sistem punjenja

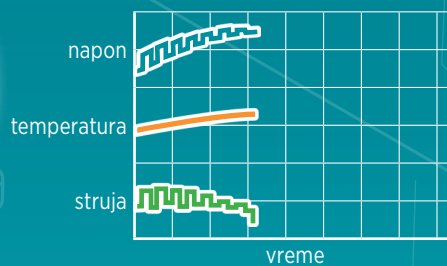

### Standardni sistem punjenja

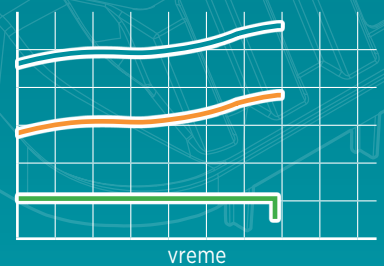

## FUNKCIJA ZAŠTITE AKUMULATORA

Komunikaciona tehnologija, koja omogućava da alat i akumulatora prate stanje i razmenu informacija, što štiti akumulator od preopterećenja, prekomernog pražnjenja i pregrevanja.

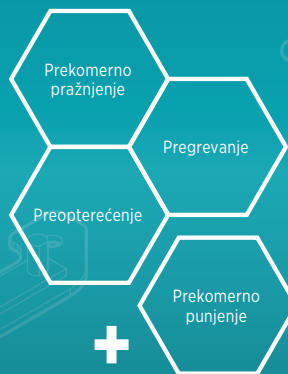

### Punjenje u bilo koje vreme

Bez memorijskog efekta. Nije potrebno pražnjenje.



### Jaka klizna konekcija





















Multikontaktne stezaljke smanjuju električnu otpornost i povećavaju stabilnost priključka, otpornost na vibracije i na kraju osiguravaju stabilno napajanje alata.







### Absorpcija šoka

Izdržljiva konstrukcija štiti akumulator od oštećenja.



# Li-ion akumulatori i punjači sa vremenskom referencom



		 DC40RA	 DC40RB*	DC40RC	 DC18RC	DC18SD	DC18SF kompatibilni sa LXT Li-ion serijom akumulatora.		DC18WC
		 ADP10 adapter za LXT baterije		 ADP10 adapter za LXT baterije	 DC18RD*  DC18RE**	 DC18SH*  DC18SE automobilski			
							1-2 akumulatora	3-4 akumulatora	
 <b>40 V max</b> Li-ion	 5,0Ah BL4050F	50 min	50 min	85 min	-	-	-	-	-
	 4,0Ah BL4040	45 min	45 min	67 min	-	-	-	-	-
	 2,5Ah BL4025	28 min	28 min	38 min	-	-	-	-	-
	 2,0Ah BL4020	22 min	22 min	30 min	-	-	-	-	-
 <b>18 V</b> Li-ion	 6,0Ah BL1860B	DC40RA + ADP10 40 min	-	DC40RC + ADP10 85 min	55 min	130 min	130 min	260 min	165 min
	 5,0Ah BL1850B	DC40RA + ADP10 35 min	-	DC40RC + ADP10 70 min	45 min	110 min	110 min	220 min	145 min
	 4,0Ah BL1840B	DC40RA + ADP10 29 min	-	DC40RC + ADP10 58 min	36 min	90 min	90 min	180 min	115 min
	 3,0Ah BL1830B	DC40RA + ADP10 22 min	-	DC40RC + ADP10 42 min	22 min	60 min	60 min	120 min	85 min
	 2,0Ah BL1820B	DC40RA + ADP10 24 min	-	DC40RC + ADP10 33 min	24 min	45 min	45 min	90 min	58 min
	 1,5Ah BL1815N	DC40RA + ADP10 15 min	-	DC40RC + ADP10 22 min	15 min	30 min	30 min	60 min	43 min

		 DC10SB	DC10WD			DC18WA	DC18WB			DC64WA
		 DC18RE**								
 <b>12 V max</b> Li-ion	 4,0Ah BL1041B	60 min	130 min			70 min	80 min			
	 2,0Ah BL1021B	30 min	70 min			90 min	105 min			
	 1,5Ah BL1016	22 min	50 min							
				<b>18 V</b> Li-ion <b>14,4 V</b> Li-ion				<b>64 V max</b> Li-ion		 4,0Ah BL6440

 PDC1200A01	 DC4001	 PDC01	
 <b>40 V max</b> Li-ion	<b>360 min</b>	 <b>40 V max</b> Li-ion	napajanje sa do 4 kom. 18V LXT akumulatora
<b>18 V ×2</b> Li-ion		<b>18 V/18 V ×2</b> Li-ion	

\*DC40RB/DC18RD/DC18SH: punjač sa 2 porta

\*\*DC18RE: punjač za LXT i CXT akumulatore

 indikator kapaciteta aku.  brzo punjenje



## Kompleti za napajanje

**40 V max**  
Li-ion

ID broj	Makpac kofer	Set uključuje			
		Akumulator	Kapacitet	Količina	Punjač
191J81-6	Tip 1	BL4025	2,5 Ah	2	DC40RA
191J97-1	Tip 1	BL4040	4,0 Ah	2	DC40RA
191U00-8	Tip 3	BL4040	4,0 Ah	2	DC40RB
191U28-6	Tip 3	BL4040	4,0 Ah	4	DC40RB
191U13-9	Tip 3	BL4050F	5,0 Ah	2	DC40RB
191U42-2	Tip 3	BL4050F	5,0 Ah	4	DC40RB
197570-9	—	BL1850B	5,0 Ah	2	DC18RC
197952-5	Tip 1	BL1830B	3,0 Ah	2	DC18RC
197954-1	Tip 1	BL1830B	3,0 Ah	4	DC18RC
199697-1	Tip 1	BL1850B	5,0 Ah	8	—
198116-4	Tip 1	BL1860B	6,0 Ah	2	DC18RC
197970-3	Tip 2	BL1830B	3,0 Ah	4	DC18RD
197503-4	Tip 3	BL1840B	4,0 Ah	4	DC18RD
197504-2	Tip 3	BL1840B	4,0 Ah	2	DC18RD
197626-8	Tip 3	BL1850B	5,0 Ah	4	DC18RD
197629-2	Tip 3	BL1850B	5,0 Ah	2	DC18RD
198077-8	Tip 3	BL1860B	6,0 Ah	2	DC18RD
198091-4	Tip 3	BL1860B	6,0 Ah	4	DC18RD
197136-5	Tip 1	BL1815N	1,5 Ah	2	DC18SD
197652-7	Tip 1	BL1016	1,5 Ah	2	DC10SB
197658-5	Tip 1	BL1021B	2,0 Ah	2	DC10SB
197641-2	Tip 1	BL1041B	4,0 Ah	2	DC10SB

**18 V**  
Li-ion

**12 V max**  
Li-ion

# Akumulatori i punjači

Model	ID broj	Kapacitet	Napon	Težina
-------	---------	-----------	-------	--------

## XGT - 40V max



BL4050F	191L47-8	5,0 Ah	40 V	1,30 kg
BL4040	191B26-6	4,0 Ah	40 V	1,00 kg
BL4025	191B36-3	2,5 Ah	40 V	0,71 kg
BL4020	632R35-7	2,0 Ah	40 V	0,69 kg

## LXT - 18V



BL1860B	632F69-8	6,0 Ah	18 V	0,66 kg
BL1850B	632F15-1	5,0 Ah	18 V	0,63 kg
BL1840B	632F07-0	4,0 Ah	18 V	0,64 kg
BL1830B	632G12-3	3,0 Ah	18 V	0,64 kg
BL1820B	632F01-2	2,0 Ah	18 V	0,39 kg
BL1815N	632A54-1	1,5 Ah	18 V	0,38 kg

## CXT - 12V max



BL1041B	632F63-0	4,0 Ah	12 V	0,37 kg
BL1021B	632F59-1	2,0 Ah	12 V	0,21 kg
BL1016	632F55-9	1,5 Ah	12 V	0,21 kg

## 64V - max



BL6440	191R06-8	4,0 Ah	64 V	2,2 kg
--------	----------	--------	------	--------

## G-serija - 14,4 / 18V



BL1820G	191N69-0	2,0 Ah	18 V	0,39 kg
BL1420G	191N76-3	2,0 Ah	14,4 V	0,33 kg
BL1815G	198186-3	1,5 Ah	18 V	0,39 kg
BL1415G	198192-8	1,5 Ah	14,4 V	0,33 kg

## Ostali akumulatori - 7,2 / 10,8 / 14,4V



BL1440B	632C17-9	4,0 Ah	14,4 V	0,52 kg
BL1430B	632G20-4	3,0 Ah	14,4 V	0,5 kg
BL1013	196066-7	1,3 Ah	10,8 V	0,17 kg
BL0715	198000-3	1,5 Ah	7,2 V	0,12 kg

## Ledni akumulator



ID broj	Kapacitet energije	Kapacitet	Napon	Težina
PDCI200A01	1.206 Wh	33,5 Ah	36 V	10,40 kg
191A64-2	432 Wh	12/24 Ah	18 / 36 V	7,0 kg

Model	ID broj	Napon	Ulaz
-------	---------	-------	------

## XGT - 40V max



DC40RA	191E07-8	40 V	230 V
DC40RC	191M90-3	40 V	230 V
DC40RB	191N09-8	40 V	230 V

## LXT - 18V



DC18WC	1910G0-1	14,4-18 V	230 V
DC18SD	194533-6	14,4-18 V	230 V
DC18SE	194621-9	14,4-18 V	12-24 V
DC18SF	196426-3	14,4-18 V	230 V
DC18RE	198720-9	12 max CXT/ 14,4-18 LXT V	230 V
DC18RC	630718-5	14,4-18 V	230 V
DC18RD	630868-6	14,4-18 V	230 V
DC18SH	630B24-0	14,4-18 V	230 V

## CXT - 12V max



DC10WD	197343-0	10,8-12 V	230 V
DC18RE	198720-9	12 max CXT/ 14,4-18 LXT V	230 V
DC10SB	630996-7	10,8-12 V	230 V

## 64V - max



DC64WA	191W19-9	64 V	230 V
--------	----------	------	-------

## G-serija - 14,4 / 18V



DC18WB	191W37-7	14,4-18 V	230 V
DC18WA	195423-6	14,4-18 V	230 V

## Ostali punjači akumulatora



DC10WA	194588-1	7,2-10,8 V	230 V
--------	----------	------------	-------



# PDC1200 IN PDC01 RUKSAK ADAPTERI

## PDC1200

### PDC1200A01

Sa integrisanim akumulatorskim ćelijama



33,5 Ah

Kapacitet



1.206 Wh

Snaga



1,1 m

Dužina kabla



PDC1200



### Srednji priključak

Akumulatorski alati sa direktnim priključkom



### 191N62-4

XGT adapter 40 V max



### 191J51-5

LXT adapter 18 + 18 V



### 191A53-7

LXT adapter 18 V



## PDC01

### 191A64-2

Koristi se sa LXT 18 V akumulatorima

Moguće priključivanje do 4 LXT akumulatora



24 Ah  
12 Ah

Kapacitet



432 Wh

Snaga



1,7 m

Dužina kabla



PDC01

## Akumulatori

## Poklopci za akumulatore

	Model	Naziv	Za model	Cena sa PDV-om
	194649-7	Štitnik akumulatora BDF/BHP/BTD	BL1430B, BL1440, BL1450, BL1460B, BL1830B, BL1840B, BL1850B, BL1860B	
	195798-3	Štitnik akumulatora za BL18XX	DDF458, DHP458, DTD146	
	422807-8	Zaštita za akumulatore	DBO380, DBO381	
	450128-8	Zaštitni poklopac za akumulator	BL1415, BL1430, BL1440, BL1815, BL1820, BL1830, BL1840, BL1850, BL1860	
	450599-9	Zaštitni poklopac za akumulator	BL1430	

## Adapteri

### Adapteri

Model	Naziv	Model	Opis	Cena sa PDV-om	
YL00000003	Držač akumulatora jakne za grejanje za 12V max CXT	/	CXT držač akumulatora jakne za grejanje i cebad		
198634-2	Držač akumulatora jakne 14,4/18V LXT baterije	/	Držač akumulatora jakne za hlađenje		
198639-2	Držač akumulatora jakne CXT 12V max baterije	/	Držač akumulatora jakne za hlađenje		
YL00000004	Držač akumulatora jakne za grejanje za 14,4/18v LXT baterije	/	LXT držač akumulatora jakne za grejanje i cebad		
SE00000078	Strujni adapter	/	Pogodan za BMR100, DMR102, DMR107, DMR116, MR001G		
TE00000442	AC adapter	/	Pogodan za DCF301, CF002G		
SE00000101	Strujni adapter	/	Pogodan za DMR103B, DMR106 (B), DMR108		
SE00000265	Strujni adapter	/	Pogodan za DMR110, MG002G, MR003G		
SE00000679	Adapter za napajanje (CE) DMR114	/	Pogodan za DMR114, MG004G		
SE00000501	AC ADAPTER (CE) DMR200	/	Pogodan za DMR200, DMR202, DMR201		
TC00000137	AC adapter	/	Pogodan za DMR300, DMR301		
TC00000142	AC kabel	/	Pogodan za DMR300, DMR301		
ADP001G	Adapter USB-dupli za 40V MAX XGT	ADP001G	Adapter za punjenje putem USB priključka za 2 mobilna uređaja (USB 5V/2,4 A) za XGT Li-Ion 40 V baterije		

Nastavak...

Akumulatori i punjači

Pribor za akumulatorske alate

Akumulatorske lampe i pribor

Pribor za laserske merace

Pribor za rušenje i udarno bušenje

Pribor za bušenje

Krunaste testere

Pribor za pritezanje

Pribor za sečenje i bušenje

Pribor za brušenje i poliranje

Pribor za profilisanje i poravnavanje

Pribor za višenamenski alat

Pribor za testere

Pribor za pneumatske alate

Pribor za fenove za vrući vazduh

Pribor za usisivanje

Pribor za alate za rad na otvoreno

Pribor za držače alata i zaštitna

Koferi i torbe

Ručni alati

Ostalo

Pribor za mješanje

## Akumulatori i punjači

	Model	Naziv	Model	Opis	Cena sa PDV-om
	193682-6	Adapter za automatsko osvežavanje	ADP03	Pogodan za DC18RA/SE/RC, DC24SC	
	DECADP05	Adapter USB-punjač	ADP05	Adapter za punjenje putem USB priključka za 2 mobilna uređaja (USB 5V/2,1A) za LXT Li-ion 14,4/18v baterije	
	ADP06	Adapter USB-punjač 12V max CXT	ADP06	Adapter za punjenje putem USB priključka za jedan mobilni uređaj (USB 5V/2,1A) za CXT Li-ion 12V max baterije	
	191C10-7	Izmenljivi adapter XGT - LXT	ADP10	Pogodan za DC40RA, DC40RC	
	197580-6	Komplet adaptera za akumulator BAP182	BAP182	Držač za akumulator - za 2 x 18V aku.	
	193689-2	Spoljni adapter za akumulator	BAP24	Adapter za baterije MAKSTAR 24 V	
	195511-9	Pretvarač za akumulator BCV01	BCV01	Adapter za 2x BL1830 pogodan za 36V alate	
	197214-1	Komplet pretvarača za akumulator BCV03	BCV03	Adapter za baterije povezuje 2 x 18 V u 1x36V bateriju	
	YL00000068	Produžni kabel 1,5m DCB200B	DCB200, CB100D		
	198900-7	Bežična jedinica za automatski start	WUT01	Pogodan za alate sa funkcijom AVS.	
	199742-2	Bežični bluetooth adapter VUT02Z, bez bluetooth čipa VUT01	WUT02	Adapter za električne usisivače sa automatskom funkcijom.	
	199790-1	Bežični bluetooth adapter VUT02Z, sa bluetooth čipom VUT01	WUT02 + WUT01		

# PRIBOR ZA AKUMULATORske ALATE



# IDEALAN PRIBOR ZA AKUMULATORSE ALATE



## Optimalni rad sa akumulatorskim alatima!

Veće brzine, više posla uz jedno punjenje akumulatora i nesmetan rad.  
Pronađite preporučenu dodatnu opremu za svoj akumulatorski alat uz pomoć 8 bežičnih ikona.

## Akumulatorske bušilice

### Poklopci za DFL i DFT modele

Model	Naziv	Za model	Cena sa PDV-om	
418032-7	Štitnik žuti	DFL061F, DFL062F, DFL063F, DFL082F, DFL083F, DFL201F, DFL124F, DFL125F, DFL203F, DFL204F		
418064-4	Štitnik plavi	DFL061F, DFL062F, DFL063F, DFL082F, DFL083F, DFL201F, DFL124F, DFL125F, DFL203F, DFL204F		
418065-2	Štitnik crveni	DFL061F, DFL062F, DFL063F, DFL082F, DFL083F, DFL201F, DFL124F, DFL125F, DFL203F, DFL204F		
418423-2	Štitnik žuti	DFT082F, DFT082R, DFT083F, DFT124F, DFT125F		
418424-0	Štitnik plavi	DFT082F, DFT082R, DFT083F, DFT124F, DFT125F		
418425-8	Štitnik crveni	DFT082F, DFT082R, DFT083F, DFT124F, DFT125F		
418743-4	Štitnik A	DFL301R, DFL402F		
418744-2	Štitnik A	DFL301R, DFL402F		
418745-0	Štitnik A	DFL301R, DFL402F		
418746-8	Štitnik B	DFL301R, DFL402F		
418750-7	Štitnik C	DFL301R, DFL402F		
450331-1	Providni štitnik	DFT082F, DFT082R, DFT083F, DFT124F, DFT125F		

 Akumulat  
ori i  
punjači

 Pribor za  
akumulat  
orske  
alate

 Akumulat  
orske  
lampe i  
pribor

 Pribor za  
laserske  
merace

 Pribor za  
rušenje i  
udarno  
bušenje

 Pribor za  
bušenje

 Krunaste  
testere

 Pribor za  
pritezani  
e

 Pribor za  
sečenje i  
brusjenje

 Pribor za  
brusjenje  
i  
poliranje

 Pribor za  
profilisanj  
e i  
poravnaj

 Pribor za  
višenam  
enski alat

 Pribor za  
testere

 Pribor za  
pneumat  
ske alate

 Pribor za  
fenove  
za vrući  
vazduh

 Pribor za  
usisivanj  
e

 Pribor za  
alate za  
rad na  
otvoreno

 Pribor za  
držače  
alata i  
zaštitna

 Koferi i  
torbe

 Ručni  
alati

Ostalo

 Pribor za  
mješanje



## Pribor za baterijske ugaone udarne odvijače

	Model	Naziv	Za model	Cena sa PDV-om
	134743-3	Nasadni ključ za krckalicu 192439-2	6940D, DTL060, DTL061, TL064D, TL065D	
	134744-1	Nasadni ključ za krckalicu 192439-2	6940D, DTL060, DTL061, TL064D, TL065D	
	134745-9	Adapter za nasadni ključ 192439-2	6940D, DTL060, DTL061, TL064D, TL065D	
	134746-7	Adapter za nasadni ključ 192439-2	6940D, DTL060, DTL061, TL064D, TL065D	
	135183-8	Ugaona glava za 1/4" umetke	6940D, DTL060, DTL061, TL064D, TL065D	
	135200-4	Ugaona glava za 25 mm 1/4" umetke	6940D, DTL060, DTL061, TL064D, TL065D	
	135201-2	Ugaona glava za 3/8" umetke	6940D, DTL060, DTL061, TL064D, TL065D	
	192439-2	Račna 21mm	6940D, DTL060, DTL061, TL064D, TL065D	
	192440-7	Prava glava za 1/4" umetke	6940D, DTL060, DTL061, TL064D, TL065D	

## Ograničivač dubine

	Model	Naziv	Za model	Cena sa PDV-om
	194280-9	Komplet graničnika	DTD152, DTD153, DTD154, DTD155, DTD157, TD001G, TD111D	

[Nastavak...](#)





# Pribor za akumulatorske alate

Model	Naziv	Za model	Cena sa PDV-om	
194281-7	Komplet graničnika sa adapterom	DTD152, DTD153, DTD154, DTD155, DTD157, TD001G, TD111D		

## Akumulatorska račna-zavrtač



### Pribor

Model	Naziv	Prihvati	Za model	Cena sa PDV-om	
191A50-3	Adapter ključ 9.5 za WR100D	3/8"	WR100D, DWR180		
191A51-1	Adapter ključ 6.35 za WR100D	1/4"	WR100D, DWR180		

Akumulatori i punjači

Pribor za akumulatorske alate

Akumulatorske lampe i pribor

Pribor za laserske merace

Pribor za rušenje i udarno bušenje

Pribor za bušenje

Krunaste testere

Pribor za pritzanije

Pribor za sečenje i brusenje

Pribor za brusenje i poliranje

Pribor za profilisanje i poravnanje

Pribor za višenamenski alat

Pribor za testere

Pribor za pneumatske alate

Pribor za fenove za vrući vazduh

Pribor za usisivanje

Pribor za alate za rad na otvoreno

Pribor za držače alata i zaštitna

Koferi i torbe

Ručni alati

Ostalo

Pribor za mješanje

## Akumulatorski pištolj za podmazivanje



## Pribor

	Model	Naziv	Za model	Cena sa PDV-om
	166094-6	Traka	DUB362, DVC350, BVC340, BVC350, DUB184, DGP180, UB001G	
	191A76-5	Adapter sa brzom spojnicom	DGP180	
	191A77-3	Ugaoni adapter	DGP180	
	191A78-1	Set adaptera (3 kom)	DGP180	
	191A79-9	Fleksibilno crijevo (1,2 m)	DGP180	
	191A80-4	Fleksibilno crijevo (0,6 m)	DGP180	
	191A81-2	Spremnik za mast (450 g)	DGP180	
	191B12-7	Spremnik za mast (400 g)	DGP180	

## Akumulatorska duvalica za prašinu



### Pribor

Model	Naziv	Opis	Prečnik	Slike
191X11-1	Mlaznica 3	Mlaznica za duvanje vazduha u ograničene prostore, uglove i površine uz zid.	3 mm	
191X13-7	Mlaznica 7	Mlaznica za skidanje prašine sa filtera.	7 mm	
191X15-3	Mlaznica 13	Mlaznica za čišćenje radnih površina, generalno čišćenje prašine, čišćenje rupa (sa korišćenjem duge mlaznice), velike predmete na naduvavanje i izduvavanje istih.	13 mm	
191X17-9	Mlaznica za naduvavanje	Mlaznica za naduvavanje/izduvavanje igrački za plažu, lopti i sličnih predmeta.	7 mm	
191X19-5	Mlaznica za razduvavanje većih površina	Mlaznica za izduvavanje prijavštine i tečnosti sa radnih stolova. Ugao duvanja je 120° sa 5 rupa.	6 mm (svaka rupica)	
191X21-8	Mlaznica za uske prostore 6	Fleksibilna mlaznica za čišćenje tesnih mesta i računarske opreme.	6 mm	
191X23-4	Mlaznica za usisavanje	Mlaznica za izduvavanje predmeta na naduvavanje.	/	
191X25-0*	Mlaznica za izduvavanje 20 -30	Mlaznica primerna za izduvavanje madraca, rafting čamaca, bazena i ostalih sličnih predmeta.	20 mm - 30 mm	
191X27-6*	Usisna mlaznica za kompresione vreće	Mlaznica je primerna za pakovanje odeće sa izduvavanje vazduha.	65 mm	
191X29-2	Filter C	Filter, zasnovan za maksimalno smanjenje ulaženja prašine u motor u prašnom radnom okruženju.	/	
191X78-9*	Duga mlaznica	Komplet mlaznica primernih za čišćenje rupa i ostalih uskih mesta. Dužinu mlaznica moguće je menjati s pričvršćivanjem i uklanjanjem dve glave mlaznice.	8 mm	

\*Za upotrebu mlaznice, mora biti prethodno nameštena mlaznica 13.

Akumulatori in polnilniki

Pribor za akumulatorsko orodje

Akumulatorske svetilke in pribor

Pribor za laserske merilnike

Pribor za rušenje in vrtanje

Pribor za vrtanje

Kronske žage

Pribor za vijčenje

Pribor za rezanje in brušenje

Pribor za poliranje in brušenje

Pribor za rezkanje in oblanje

Pribor za multifunkcijsko orodje

Pribor za žaganje

Pribor za zebjalnike in spenjalnike

Pribor za fene

Pribor za sesanje

Pribor za uporabo na prostem

Pribor za nošenje orodja za zaštitna oprema

Kovčki in torbe za orodje

Ročno orodje







Razno

Pribor za mešanje

## Akumulatorska vakum pumpa za klima uređaje



## Pribor za akumulatorsku vakum pumpu

	Model	Naziv	Za model	Cena sa PDV-om
	AS000VP042	Pojas za nošenje aluminijumskog kofera	DVP180	
	AS00VP050M	Ulje za vakum pumpu (150ml)	DVP180	
	AS00XP808M	Manometar	DVP180	
	AS0AI154MK	Crevo za vakumiranje	DVP180	
	AS0VP007MK	Aluminijski kofer	DVP180	
	AS0VP051MK	Ventil protoka vazduha sa manometrom	DVP180	
	AS0Y06110K	Adapter	DVP180	

# Pribor za akumulatorske alate

## Akumulatorski pištolj za zakivanje



### Pribor

Model	Naziv	Prečnik zakivaka (mm)	Za model	Jedinica (kom/kompl)	Cena sa PDV-om	
162500-9	Kontejner za sakupljanje igala za DRV150 DRV250	/	DRV150, DRV250	1		
191D57-7	Mast za podmazivanje DRV150,250	/	DRV150, DRV250	1		
199729-4	Uvodnik set za 2.4 za DRV150, DVR250	2.4	DRV150, DRV250	1		
199731-7	Čeljusti 4.8 DRV150, DRV250	2.4 - 4.8	DRV150, DRV250	3/1		
199728-6	Uvodnik set za 3.2 za DRV150, DVR250	3.2	DRV150, DRV250	1		
191C04-2	Uvodnik set B za 4.0 za DRV150, DVR250	4.0	DRV150, DRV250	1		
191F80-4	Uvodnik set A za 4.0 za DRV250	4.0	DRV250	1		
191C03-4	Uvodnik set B for 4.8 za DRV150, DVR250	4.8	DRV150, DRV250	1		
191F79-9	Uvodnik set A za 4.8 za DRV250	4.8	DRV250	1		
199726-0	Uvodnik set A za 4.8 za DRV250	4.8	DRV250	1		
199730-9	Čeljusti 6.4 DRV250	4.8 - 6.4	DRV250	3/1		

Nastavak...

- Akumulatori i punjači
- Pribor za akumulatorske alate
- Akumulatorske lampe i pribor
- Pribor za laserske merace
- Pribor za rušenje i bušenje
- Pribor za bušenje
- Krunaste testere
- Pribor za pritezanje
- Pribor za sečenje i brušenje
- Pribor za brušenje i poliranje
- Pribor za profilisanje i poravnavanje
- Pribor za višenamenski alat
- Pribor za testere
- Pribor za pneumatske alate
- Pribor za fenove za vrući vazduh
- Pribor za usisivanje
- Pribor za alate za rad na otvoreno
- Pribor za držače alata i zaštitna
- Koferi i torbe
- Ručni alati
- Ostalo
- Pribor za mješanje













# Pribor za akumulatorske alate

	Model	Naziv	Prečnik zakivaka (mm)	Za model	Jedinica (kom/kompl)	Cena sa PDV-om
	199725-2	Uvodnik set za 6.0 za DRV250	6.0	DRV250	1	
	191F78-1	Uvodnik set za 6.4 za DRV250	6.4	DRV250	1	

## Akumulatorski pištolji za zaptivanje

### Držači za patrone



	Model	Naziv	Zapremina (l)	Za model	Cena sa PDV-om
	123221-8	Klip C za 600 ml držač	/	CG100D, DCG180	
	141861-0	Držač 600 ml	/	CG100D, DCG180	
	142041-1	Osovina za 300 ml držač	/	CG100D, DCG180	
	142042-9	Osovina za 600 ml držač	/	CG100D, DCG180	
	142071-2	Klip A za 300 ml i za 600 ml držač	/	CG100D, DCG180	
	142072-0	Klip B za 600 ml držač	/	CG100D, DCG180	
	191P89-6	Držač patrona, 400 ml	0,4	CG100D, DCG180	
	196351-8	Držač patrona, 300 ml	0,3	CG100D, DCG180	
	196352-6	Držač patrona, 600 ml	0,6	CG100D, DCG180	
	318958-2	Držač tip B	/	CG100D, DCG180	
	454223-6	Spoj 300 ml držača	/	CG100D, DCG180	
	454226-0	Brizgaljka 600 ml držača	/	CG100D, DCG180	

Nastavak...



# Pribor za akumulatorske alate

Model	Naziv	Zapremina (l)	Za model	Cena sa PDV-om	
454275-7	Držač 300 ml	/	CG100D, DCG180		

## Akumulatorski alat za vezivanje armature



### Pribor

Model	Naziv	Prečnik Ø (mm)	Ukupna dužina (m)	Za model	Jedinica (kom/kompl)	Cena sa PDV-om	
162755-6	Četkica za čišćenje	/	/	DTR180	1		
191M27-0	Produžna ručka za DTR180	/	0,175	DTR180	1		
199137-9	Set žice za vezivanje	8	100	DTR180	50/1		

Akumulatori i punjači

Pribor za akumulatorske alate

Akumulatorske lampe i pribor

Pribor za laserske merace

Pribor za rušenje i udarno bušenje

Pribor za bušenje

Krunaste testere

Pribor za pritzanje

Pribor za sečenje i brušenje

Pribor za brušenje i poliranje

Pribor za profilisanje i poravnanje

Pribor za višenamenski alat

Pribor za testere

Pribor za pneumatske alate

Pribor za fenove za vrući vazduh

Pribor za usisivanje

Pribor za rad na otvoreno

Pribor za držače alata i zaštitna

Koferi i torbe

Ručni alati





Ostalo

Pribor za mješanje

## Akumulatorski sekači za navojne šipke



## Rezne ploče za DSC102, SC103D

	Model	Naziv	Tip vijka	Za model	Cena sa PDV-om
	199069-0	Kaiš za nošenje o rame	/	DSC102, SC103D	
	199083-6	Komplet noževa sa dva ruba M10	M10	DSC102, SC103D	
	199085-2	Komplet noževa sa dva ruba M8	M8	DSC102, SC103D	
	199087-8	Komplet noževa sa dva ruba M6	M6	DSC102, SC103D	



## Rezne ploče za DSC121

	Model	Naziv	Tip vijka	Za model	Cena sa PDV-om
	SC09002700	Noževi M8 DSC123	M8	DSC121	
	SC09002710	Noževi M10 DSC122	M10	DSC121	
	SC09002720	Noževi M12 DSC121	M12	DSC121	

[Nastavak...](#)



# Pribor za akumulatorske alate

Model	Naziv	Tip vijka	Za model	Cena sa PDV-om
SC09002730	Noževi W3/8 DSC121	3/8"	DSC121	

## Akumulatorski sekač čeličnih šipki



### Rezne ploče



Model	Naziv	Za model	Cena sa PDV-om
SC09002470	Noževi set za DSC163	DSC163	

## Akumulatorski rezač čeličnih šipki



### Rezne ploče

Za DSC250 pored lista SC09003260, potreban je odbojnik SC09030550.

Model	Naziv	Prečnik lista testere (Ø) (mm)	Unutrašnji prečnik (Ø) (mm)	Broj zuba	Najveći broj obrtaja (min <sup>-1</sup> )	Za model	Cena sa PDV-om
SC09002890	TCT list testere	110	15	24	2.200	DSC250	
SC09003260	TCT list testere	110	15	24	2.200	DSC250, DSC251	
SC09030550	Odbojnik za DSC250	/	/	/	/	DSC250, DSC251	

Akumulatori i punjači

Pribor za akumulatorske alate

Akumulatorske lampe i pribor

Pribor za laserske merace

Pribor za rušenje i udarno bušenje

Pribor za bušenje

Krunaste testere

Pribor za pritezanje

Pribor za sečenje i brušenje

Pribor za brušenje i poliranje

Pribor za profilisanje i poravnanje

Pribor za višenamenski alat

Pribor za testere

Pribor za pneumatske alate

Pribor za fenove za vrući vazduh

Pribor za usisavanje

Pribor za alate za rad na otvoreno

Pribor za držače alata i zaštitna

Koferi i torbe

Ručni alati



Ostalo

Pribor za mješanje

## Akumulatorski sekač za beton



## Pribor

	Model	Naziv	Za model	Cena sa PDV-om
	126738-0	Kesa za prašinu	4100KB, DCC500	
	191N83-6	Komplet poklopca za odvođenje prašine	DCC500	
	191X01-4	Komplet priključka za vodu	DCC500	

## Akumulatorski višenamenski sekač



## Rezne ploče

	Model	Naziv	Za model	Cena sa PDV-om
	198603-3	Komplet noževa	CP100D	

# Pribor za akumulatorske alate

27

## Akumulatorski kompresor



### Pribor

Model	Naziv	Maks. pritisak (bar)	Za model	Cena sa PDV-om	
TE00000592	Adapter za ventile	0,9	MP100, DMP180, DMP181, MP001G		
TE00000346	Adapter za ventile	3	MP100, DMP180, DMP181, MP001G		
TE00000333	Adapter za ventile	0,5	MP100, DMP180, DMP181, MP001G		
TE00000334	Adapter za ventile	7	MP100, DMP180, DMP181, MP001G		

## Akumulatorske suvomontažne testere



### Pribor

Dubinu reza je moguće prilagoditi debljini gips/drvene ploče

Model	Materijal lista	Ukupna dužina (mm)	Širina (mm)	Debljina lista (mm)	Pogodno za	Za model	Jedinica (kom/kompl)	Cena sa PDV-om	
456624-4	/				/	DSD180, SD100D	1		
B-49703	HCS	55	18	0,55	gips ploče	DSD180, SD100D	2/1		
B-49703-10	HCS	55	18	0,55	gips ploče	DSD180, SD100D	10/1		
B-49719	HCS	55	18	0,55	drvo	DSD180, SD100D	2/1		

Akumulatori i punjači

Pribor za akumulatorske alate

Akumulatorske lampe i pribor

Pribor za laserske merace

Pribor za rušenje i udarno bušenje

Pribor za bušenje

Krunaste testere

Pribor za pritezanje

Pribor za sečenje i brusenje

Pribor za brusenje i poliranje

Pribor za profilisanje i poravnanje

Pribor za višenamenski alat

Pribor za testere

Pribor za pneumatske alate

Pribor za fenove za vrući vazduh

Pribor za usisivanje

Pribor za alate za rad na otvoreno

Pribor za držače alata i zaštitna

Koferi i torbe

Ručni alati



Ostalo

Pribor za mješanje

## Akumulatorska brusilica za gips



## Pribor

	Model	Naziv	Prečnik Ø (mm)	Dimenzije (D x Š x V) (mm)	Za model	Cena sa PDV-om
	140J85-5	Zamenske četke A	/	/	DSL800	
	140J86-3	Zamenske četke B	/	/	DSL800	
	195638-5	Torba za alat		1.200 x 300 x 350	DSL800, DSL801, DUX60, UX01G, DUX18	
	199937-7	Komplet produžnog rukohvata	/	800	DSL800, DSL801	
	199938-5	Podložni jastučić Grubi	220	/	DSL800, DSL801	
	199939-3	Podložni jastučić mekani	210	/	DSL800, DSL801	
	199940-8	Podložni jastučić Srednji	210	/	DSL800, DSL801	
	743127-0	Zamenske četke	/	/	DSL801	

# Pribor za akumulatorske alate





## Brusni diskovi

Model	Prečnik Ø (mm)	Granulacija	Broj rupa	Čičak	Za model	Jedinica (kom/kompl)	Cena sa PDV-om
B-68389	225	40	9	•	DSL800	25/1	
B-68395	225	80	9	•	DSL800	25/1	
B-68404	225	120	9	•	DSL800	25/1	
E-02375	225	150	9	•	DSL800	25/1	
B-68410	225	180	9	•	DSL800	25/1	
E-02381	225	220	9	•	DSL800	25/1	
B-68426	225	320	9	•	DSL800	25/1	

## Pribor za mašine za poliranje















### Pribor za poliranje

Model	Naziv	Prečnik Ø (mm)	Opis	Za model	Cena sa PDV-om	
191N90-9	Sunderasta podloga za poliranje žuta 80mm	80	Sundjer za nanošenje voska	DPV300, PV301D		
191N91-7	Sunderasta podloga za poliranje bela 80mm	80	Sundjer za uklanjanje voska	DPV300, PV301D		
191N92-5	Podloga od vune za poliranje 80mm	80	Vunena podloga za visoki sjaj sa voskom	DPV300, PV301D		
743125-4	Držač podloga 75mm	75		DPV300, PV301D		

- Akumulatori i punjači
- Pribor za akumulatorske alate
- Akumulatorske lampe i pribor
- Pribor za laserske merace
- Pribor za rušenje i udarno bušenje
- Pribor za bušenje
- Krunaste testere
- Pribor za pritezanje
- Pribor za sečenje i brušenje
- Pribor za brušenje i poliranje
- Pribor za profilisanje i poravnavanje
- Pribor za višenamenski alat
- Pribor za testere
- Pribor za pneumatike alate
- Pribor za fenove za vrući vazduh
- Pribor za usisavanje
- Pribor za alate za rad na otvoreno
- Pribor za držače alata i zaštitna
- Koferi i torbe
- Ručni alati
- Ostalo
- Pribor za mješanje

# Pribor za akumulatorske alate

## Pribor za brušenje

	Model	Naziv	Prečnik Ø (mm)	Čičak	Granulacija	Grubost diska	Tip	Za model	Jedinica (kom/kompl)	Gena sa PDV-om
	743124-6	Tvrda gumena podloga	46		/	/	/	DPV300, PV301D	1	
	743126-2	Adapter za tvrdu gumenu podlogu	/		/	/	/	DPV300, PV301D	1	
	E-07412	Brusni papir 50mm A60	50	•	60	/	/	DPV300, PV301D	25/1	
	E-07428	Brusni papir 50mm A80	50	•	80	/	/	DPV300, PV301D	25/1	
	E-07434	Brusni papir 50mm A120	50	•	120	/	/	DPV300, PV301D	25/1	
	E-07440	Brusni papir 50mm Z60	50	•	60	/	/	DPV300, PV301D	25/1	
	E-07456	Brusni papir 50mm Z80	50	•	80	/	/	DPV300, PV301D	25/1	
	E-07462	Brusni disk 50mm veoma tvrd	50	•	/	gruba	Tvrd	DPV300, PV301D	25/1	
	E-07478	Brusni disk 50mm veoma tvrd	50	•	/	srednje gruba	Tvrd	DPV300, PV301D	25/1	
	E-07484	Brusni disk 50mm tvrdi	50	•	/	fina	Tvrd	DPV300, PV301D	25/1	
	E-07490	Brusni disk 50mm srednje mekan	50	•	/	srednje gruba	Mek	DPV300, PV301D	25/1	
	E-07509	Brusni disk 50mm mekan	50	•	/	fina	Mek	DPV300, PV301D	25/1	
	E-07515	Brusni disk 50mm veoma mekan	50	•	/	super fina	Mek	DPV300, PV301D	25/1	

## Baterijski robotski usisivač



### Pribor

Model	Naziv	Za model	Jedinica (kom/kompl)	Cena sa PDV-om	
191P18-9	Alu. traka za ograničavanje	DRC300	1		
191P20-2	Četka (mekana)	DRC300	1		
191P22-8	Četka	DRC300	1		
191X35-7	Bočna zaštita	DRC300	1		
SH00000063	Četka	DRC200	1		
SH00000065	Bočne četke	DRC200	2/1		
SH00000213	Filter	DRC200	1		
SH00000231	Alu. traka za ograničavanje, 15m	DRC200	1		
SH00000314	Štitnik četke	DRC200	1		

Akumulatori i punjači

Pribor za akumulatorske alate

Akumulatorske lampe i pribor

Pribor za laserske merace

Pribor za rušenje i udarno bušenje

Pribor za bušenje

Krunaste testere

Pribor za pritzanije

Pribor za sečenje i brušenje

Pribor za brušenje i poliranje

Pribor za profilisanje i poravnanje

Pribor za višenamenski alat

Pribor za testere

Pribor za pneumatske alate

Pribor za fenove za vrući vazduh

Pribor za usisivanje

Pribor za alate za rad na otvoreno

Pribor za držače alata i zaštitna

Koferi i torbe

Ručni alati



Ostalo

Pribor za mješanje

## Akumulatorska kolica







## Pribor

	Model	Naziv	Dimenzije (D x Š x V) (mm)	Zapremina (l)	Opis	Za model	Cena sa PDV-om
	191A01-6	Pomoćni točkovi	150 x 530 x 180	/	Pomoćni točkovi smanjuju naginjanje DCU180 kolica usled raspodele tereta prilikom procesa utovara i istovara	DCU180	
	199008-0	Korito	/	90	Pogodno za pesak, šljunak, praškaste materijale i sl.	DCU180	
	199009-8	Nosač	1.110 - 1.350 x 820 - 1.010 x 820 - 900	/	Pogodan za kabast tovar zahvaljujući mogućnosti uklanjanja bočnih cevi.	DCU180	

## Akumulatorski frižider i kutija za zagrevanje



## Pribor

	Model	Naziv	Ukupna dužina (m)	Model	Cena sa PDV-om
	A-71093	Traka	/	DCW180, CW001G	
	WL00000002	Kabl za napajanje 12-24V	2,5	DCW180, CW001G	
	WL000000058	Strujni adapter 230V	2	DCW180	
	WL00000122	Strujni adapter 230V	2	CW001G	



# Pribor za akumulatorske alate

## Akumulatorski grejač vode



### Pribor

Model	Naziv	Za model	Cena sa PDV-om
KF00000076	Gornji poklopac	KT001G, DKT360	
KF00000085	Kotlić	KT001G, DKT360	



## Akumulatorski aparat za kafu



### Pribor

Model	Naziv	Za model	Cena sa PDV-om
KF00000012	Set za fioku	DCM501	
KF00000014	Donji uložak za kavu	DCM501	
KF00000020	Šoljica	DCM501	
KF00000066	Set filtera	DCM501	



Nastavak...

- Akumulatori i punjači
- Pribor za akumulatorske alate
- Akumulatorske lampe i pribor
- Pribor za laserske merace
- Pribor za rušenje i udarno bušenje
- Pribor za bušenje
- Krunaste testere
- Pribor za pritezanje
- Pribor za sečenje i brušenje
- Pribor za brušenje i poliranje
- Pribor za profilisanje i poravnavanje
- Pribor za višenamenski alat
- Pribor za testere
- Pribor za pneumatske alate
- Pribor za fenove za vrući vazduh
- Pribor za usisivanje
- Pribor za alate za rad na otvoreno
- Pribor za držače alata i zaštitna
- Koferi i torbe
- Ručni alati
- Ostalo
- Pribor za mješanje

# Pribor za akumulatorske alate

	Model	Naziv	Za model	Cena sa PDV-om
	KF00000069	Poklopac za zaštitu alata od prašine	DCM501	







- Akumulat  
ori i  
punjači
- Pribor za  
akumulat  
orske  
alate
- Akumulat  
orske  
lampe i  
pribor
- Pribor za  
laserske  
merace
- Pribor za  
rušenje i  
udarno  
bušenje
- Pribor za  
bušenje
- Krunaste  
testere
- Pribor za  
pritezani  
e
- Pribor za  
sečenje i  
brusenje
- Pribor za  
brusenje  
i  
poliranje
- Pribor za  
profilisanje  
e i  
poravnava
- Pribor za  
višenam  
enski alat
- Pribor za  
testere
- Pribor za  
pneumat  
ske alate
- Pribor za  
fenove  
za vrući  
vazduh
- Pribor za  
usisivanje
- Pribor za  
alate za  
rad na  
otvoreno
- Pribor za  
držače  
alata i  
zaštitna
- Koferi i  
torbe
- Ručni  
alati
- Ostalo
- Pribor za  
mješanje

# PROBIJAČ I PRIPADAJUĆE PODLOGE

## Akumulatorski probijač za metal: DPP200

U donjoj tabeli pronađićete optimalnu kombinaciju bušača i šablona u skladu sa materijalom.

Okrugli probijači i šablони						
 Probijač		 Probijač		Materijal		
				Zatezna čvrstoća	Ugaoni profili	Zatezna čvrstoća
Dimenzija (mm)	Šifra artikla	Dimenzija (mm)	Šifra artikla	Čelik (65.000 psi)		Debljina
6	SC05340040	6	SC00000203	t2-t4	-	t3-t4
6,5	SC05340050	6,5	SC00000205	t2-t6	-	t3-t4
8	SC05340060	8	SC00000207	t2-t6	-	t3-t4
8,5	SC05340070	8,5	SC00000209	t2-t6	-	t3-t4
10	SC05340080	10	SC00000211	t2-t6	t7,5	t3-t4
11	SC05340090	11	SC00000213	t2-t8	t7,5	t3-t6
12	SC05340100	12	SC00000215	t2-t8	t7,5	t3-t6
13	SC05340110	13	SC00000217	t2-t8	t7,5	t3-t6
14	SC05340120	14	SC00000219	t2-t8	t7,5	t3-t6
15	SC05340130	15	SC00000221	t2-t8	t7,5	t3-t6
16	SC05340140	16	SC05332710	t2-t8	t7,5	t3-t6
18	SC05340150	18	SC00000223	t2-t8	t7,5	t3-t6
19	SC05340170	19	SC05332740	t2-t8	t7,5	t3-t6
20	SC05340160	20	SC05352510	t2-t8	t7,5	t3-t6

Za probijanje ovalnih rupa						
 Probijač		 Probijač		Materijal		
				Zatezna čvrstoća	Ugaoni profili	Zatezna čvrstoća
Dimenzija (mm)	Šifra artikla	Dimenzija (mm)	Šifra artikla	Čelik (65.000 psi)		Debljina
6,5 × 10	SC05340200	6,5 × 10	SC00000244	t2-t6	-	t3-t4
6,5 × 13	SC05340210	6,5 × 13	SC00000246	t2-t6	-	t3-t4
8,5 × 13	SC05340220	8,5 × 13	SC00000248	t2-t6	-	t3-t4
8,5 × 17	SC05340230	8,5 × 17	SC00000250	t2-t6	-	t3-t4
9 × 13,5	SC05340240	9 × 13,5	SC00000252	t2-t6	-	t3-t4
9 × 18	SC05340250	9 × 18	SC00000254	t2-t6	-	t3-t4
10 × 15	SC05340260	10 × 15	SC00000256	t2-t8	t7,5	t3-t6
10 × 20	SC05340270	10 × 20	SC00000258	t2-t8	t7,5	t3-t6
11 × 16,5	SC05340280	11 × 16,5	SC00000260	t2-t8	t7,5	t3-t6
12 × 18	SC05340290	12 × 18	SC00000262	t2-t8	t7,5	t3-t6
13 × 19,5	SC05340300	13 × 19,5	SC00000264	t2-t8	t7,5	t3-t6
14 × 21	SC05340310	14 × 21	SC00000266	t2-t8	t7,5	t3-t6

**Radni stolak**  
SC03801080



**Klizni graničnik**  
SC03300790



**Hidraulično ulje**  
SC00000106



# AKUMULATORSKÉ LAMPE I PRIBOR



# Akumulatorske LED lampe i reflektori

DML813



LED

DML814



LED

DEADML810



LED

DEAML003G



LED

DEADML809



DC AC LED

<b>Napon akumulatora</b>	18V <b>LXT</b>	18V <b>LXT</b>	18V <b>LXT</b> <b>Co</b> <b>4+</b>	40V max <b>XGT</b>	18V <b>LXT</b>
<b>Neprekidna upotreba</b>	<b>10 / 5,5 / 3 h</b> sa BL1850B (1./2./3. broj)	<b>10 / 5,5 / 3 h</b> sa BL1850B (1./2./3. broj)	<b>15 / 7 / 3,5 h</b> sa BL1850B*2 (1./2./3. broj)	<b>22 / 10 h</b> sa BL4040 (1./2. broj)	<b>7,5 / 3,5 / 1,4 h</b> sa BL1850B*2 (1./2./3. broj)
<b>Osvetljenost</b>	<b>400 / 750 / 1.250 lx</b> (1./2./3. broj) 1 m od izvora svetla	<b>400 / 750 / 1.250 lx</b> (1./2./3. broj) 1 m od izvora svetla	<b>150 / 300 / 550 lx</b> (1./2./3. broj) 1 m od izvora svetla	<b>200 / 500 lx</b> (1./2. broj) 1 m od izvora svetla	<b>800 / 1.500 / 3.800 lx</b> (1./2./3. broj) 1 m od izvora svetla
<b>Svetlosni fluks (lm = lumena)</b>	<b>900 / 1.700 / 3.000 lm</b> (1./2./3. broj)	<b>900 / 1.700 / 3.000 lm</b> (1./2./3. broj)	<b>1.500 / 3.000 / 5.500 lm</b> (1./2./3. broj)	<b>450 / 1.100 lm</b> (1./2. broj)	<b>2.000 / 4.000 / 10.000 lm</b> (1./2./3. broj)
<b>Težina</b>	<b>7,9 kg</b>	<b>8,1 kg</b>	<b>15,3 kg</b>	<b>4,7 kg</b>	<b>7,0 kg</b>

DEADML811



DC AC LED

DEADML805



DC AC LED

DEBDM1812



LED

ML001G



LED

DEADML808



LED / funkcija zumiranja

<b>Napon akumulatora</b>	18V <b>LXT</b>	18V <b>LXT</b>	18V <b>LXT</b>	40V max <b>XGT</b>	18V <b>LXT</b>
<b>Neprekidna upotreba</b>	<b>11 / 5,5 / 2,7 h</b> sa BL1850B (1./2./3. broj)	<b>17 / 8,5 h</b> sa BL1850B (1./2. broj)	<b>8,5 / 6,5 / 5 / 7 h</b> sa BL1850B tačka / rasuto / tačka + rasuto / treperenje	<b>55 h</b> sa BL4040	<b>26 h</b> sa BL1850B
<b>Osvetljenost</b>	<b>350 / 800 / 1.800 lx</b> (1./2./3. broj) 1 m od izvora svetla	<b>200 / 300 lx</b> (1./2. broj) 1 m od izvora svetla	<b>71.000 / 520 lx</b> tačka / rasuto / 0,5 m od izvora svetla	<b>3.000 lx</b> 1 m od izvora svetla	<b>170 - 4.500 lx</b> 1 m od izvora svetla
<b>Svetlosni fluks (lm = lumena)</b>	<b>750 / 1.500 / 3.000 lm</b> (1./2./3. broj)	<b>450 / 750 lm</b> (1./2. broj)	<b>600 / 1.000 / 1.250 lm</b> tačka / rasuto / tačka + rasuto	<b>160 lm</b>	<b>190 lm</b>
<b>Težina</b>	<b>4,8 kg</b>	<b>2,7 kg</b>	<b>1,6 kg</b>	<b>1,3 kg</b>	<b>1,09 kg</b>

DEBDM1815



Xenon svetlo

DEAML106



LED / funkcija zumiranja

ML002G



USB **XPT** LED

DEBDM1806



LED

DEAML104



USB **XPT** LED

<b>Napon akumulatora</b>	18V <b>LXT</b>	12V max <b>CXT</b>	40V max <b>XGT</b>	18V <b>LXT</b>	12V max <b>CXT</b>
<b>Neprekidna upotreba</b>	<b>45 h</b> sa BL1850B	<b>do 12 h</b> sa BL1041B	<b>51 / 29 / 16 h</b> sa BL4040 lampa / 180° / 360° svetlo	<b>59 / 21 / 11 h</b> sa BL1850B lampa / 180° / 360° svetlo	<b>do 19 / 17 h</b> lampa / 90° svetlo sa BL1041B
<b>Osvetljenost</b>	<b>3.000 lx</b> 1 m od izvora svetla	<b>170 - 4.500 lx</b> 1 m od izvora svetla	<b>1.900 / 310 / 340 lx</b> lampa (na vrhu) / 180° / 360° svetlo 0,5 m od izvora svetla	<b>2.100 / 280 / 310 lx</b> lampa (na vrhu) / 180° / 360° svetlo 0,5 m od izvora svetla	<b>1.900 / 190 / 340 lx</b> lampa (na vrhu) / 90° / 360° svetlo 0,5 m od izvora svetla
<b>Svetlosni fluks (lm = lumena)</b>	<b>160 lm</b>	<b>190 lm</b>	<b>130 / 340 / 710 lm</b> lampa (na vrhu) / 180° / 360° svetlo	<b>90 / 310 / 620 lm</b> lampa (na vrhu) / 180° / 360° svetlo	<b>130 / 190 / 710 lm</b> lampa (na vrhu) / 90° / 360° svetlo
<b>Težina</b>	<b>0,93 kg</b>	<b>0,78 kg</b>	<b>1,5 kg</b>	<b>1,0 kg</b>	<b>0,78 kg</b>

## Akumulatorske LED lampe i reflektori

ML006GX



LED / sa difuzorom svetla

DML816X

**USB** **XPT**  
LED / sa difuzorom svetla

DEADML801



LED

DEADML801X



LED / sa difuzorom svetla

DEADML800



LED

<b>Napon akumulatora</b>	40V max <b>XGT</b>	40V max <b>XGT</b>	18V <b>LXT</b>	18V <b>LXT</b>	18V <b>LXT</b>
<b>Neprekidna upotreba</b>	<b>82 / 40 / 20 h</b> sa BL4040 (1./2./3. broj)	<b>75 / 34 / 17 h</b> sa BL1860B (1./2./3. broj)	<b>40 / 17 h</b> sa BL1850B (1./2. broj)	<b>40 / 17 h</b> sa BL1850B (1./2. broj)	<b>36 h</b> sa BL1850B
<b>Osvetljenost</b>	<b>180 / 400 / 800 lx</b> 0,5 m od izvora svetla	<b>180 / 400 / 800 lx</b> 0,5 m od izvora svetla	<b>200 / 400 lx</b> (1./2. broj) 0,5 m od izvora svetla	<b>200 / 400 lx</b> (1./2. broj) 0,5 m od izvora svetla	<b>2.000 lx</b> 1 m od izvora svetla
<b>Svetlosni fluks</b> (lm = lumena)	<b>100 / 250 / 500 lm</b>	<b>100 / 250 / 500 lm</b>	<b>120 / 240 lm</b> (1./2. broj)	<b>120 / 240 lm</b> (1./2. broj)	<b>100 lm</b>
<b>Težina</b>	<b>1,7 kg</b>	<b>1,1 kg</b>	<b>0,98 kg</b>	<b>0,98 kg</b>	<b>0,91 kg</b>

DEAML103



LED

DEAML102



LED

<b>Napon akumulatora</b>	12V max <b>CXT</b>	7,2V / 10,8V
<b>Neprekidna upotreba</b>	<b>do 28 h</b> sa BL1041B	<b>do 8 h</b> sa BL1013
<b>Osvetljenost</b>	<b>240 / 50 lx</b> 0,5 / 1 m od izvora svetla	<b>120 / 80 lx</b> lampa (na vrhu) / 360° svetlo 0,5 / 0,4 m od izvora svetla
<b>Svetlosni fluks</b> (lm = lumena)	<b>100 lm</b>	<b>100 lm</b>
<b>Težina</b>	<b>0,43 kg</b>	<b>0,4 kg</b>



USB ulaz za punjenje mobilnog telefona



poboljšana zaštita od vode i prašine



napajanje preko akumulatora ili naponskog kabla





## Pribor za lampe

### Sijalice

Model	Naziv	Napon cijalice (V)	Za model	Jedinica (kom/kompl)	Cena sa PDV-om	
192242-1	Komplet sijalica	7,2	ML702	2/1		
192545-3	Komplet sijalica	9,6	ML902, ML903	2/1		
A-30542	Komplet sijalica	18	ML180, DML185	2/1		
A-30673	Komplet sijalica	9,6-12	ML121	2/1		
A-83973	Komplet sijalica	9,6-14,4	ML120, ML124, ML140, ML141, DML145	2/1		
A-87367	Fluorescentna cev za osvetljavanje	9,6-14,4	ML122, ML142	1		
A-87373	Komplet sijalica	24	DML240	2/1		
B-07303	Komplet sijalica	14,4-18	DML184	2/1		
GM00001161	Fluorescentna cev za osvetljavanje	14,4-18	DML184	1		

### Ostali pribor

Model	Naziv	Za model	Visina (mm)	Cena sa PDV-om	
A-58154	Anti refleksna folija	DML805	/		
GM00001028	Kuka	ML04, ML002, ML001G, ML002G	/		

Nastavak...

 Akumulat  
ori i  
punjači

 Pribor za  
akumulat  
orske  
lampe i  
alate

 Akumulat  
orske  
lampe i  
pribor

 Pribor za  
laserske  
merace

 Pribor za  
rušenje i  
udarno  
bušenje

 Pribor za  
bušenje

 Krunaste  
testere

 Pribor za  
pritezanj  
e

 Pribor za  
sečenje i  
brusenje

 Pribor za  
brusenje  
i  
poliranje

 Pribor za  
profilisanj  
e i  
poravnaj

 Pribor za  
višenam  
enski alat

 Pribor za  
testere

 Pribor za  
pneumat  
ske alate

 Pribor za  
fenove  
za vrući  
vazduh

 Pribor za  
usisivanj  
e

 Pribor za  
alate za  
rad na  
otvoreno

 Pribor za  
držače  
alata i  
zaštitna











 Koferi i  
torbe

 Ručni  
alati

Ostalo

 Pribor za  
mješanje

## Akumulatorske lampe i pribor

	Model	Naziv	Za model	Visina (mm)	Cena sa PDV-om
	GM00001157	Fleksibilni držač	ML101	/	
	GM00001326	Difuzor	DML816, ML001G	/	
	GM00001396	Stega za postavljanje na cev	DML805	/	
	GM00001683	Magnetni dodatak	ML104, ML105, ML106	/	
	GM00002073	Stativ	DML809, DML811	1.300 - 2.000	
	GM00002283	Stativ	DML805	992 - 1.750	
	GM00002286	Difuzor za DML809	DML809	/	
	GM00002287	Difuzor za DML811	DML811	/	
	GM00002312	Difuzor za ML003G	ML003G	/	
	TD00000001	Torba za transport	DML813, DML814	/	
	TD00000002	Pojas za torbu	TD00000001	/	







# PRIBOR ZA LASERSKE MERAČE









## Stativi za laserske merače i ostali pribor

## Stativi

	Model	Naziv	Veličina navoja	Visina (mm)	Cena sa PDV-om
	P-81088	Podesivi stativ 1,65m	5/8"	440 - 1.650	
	P-81315	Podesivi stativ 2,70m	5/8"	1.000 - 2.700	
	TK0LM2000F	Mini tripod	5/8"	400 - 1.100	
	TK0LM4001F	Podesivi stativ	5/8"	680 - 1.800	
	TK0LM5030F	Podesivi stativ	5/8"	780 - 2.900	

## Ostali pribor

	Model	Naziv	Za model	Cena sa PDV-om
	199010-3	USB kabal	SK312GD, SK209GD	
	199011-1	Kaiš za ruku	SK312GD, SK209GD	
	199178-5	USB kabal	SK105, SK106	
	832173-9	Torba za lasere	SK105D, SK105GD, SK106D, SK106GD, SK700D, SK700GD	
	CP00000001	Adapter za CXT lasere (8xAA baterije)	SK10GD, SK20GD, SK209GD, SK312GD, SK40GD, SK700D, SK700GD	
	LE00758831	Ciljna ploča za laser	SK105, SK106, SK700D	

[Nastavak...](#)

# Pribor za laserske merače

Model	Naziv	Za model	Cena sa PDV-om	
LE00785519	Kuglični adapter 1/4"	SK102Z, SK103PZ, SK104Z		
LE00785633	Magnetni držač koji se montira na zid 5/8"-1/4"	SK102Z, SK103PZ, SK104Z		
LE00785637	Držač lasera za zid 1/4"	SK102Z, SK103PZ, SK104Z		
LE00785640	Laserski detektor	SK102Z, SK103PZ, SK104Z		
LE00796587	Prijemnik LR150	SKR200Z		
LE00796588	Upravljač RC30	SKR200Z		
LE00823195	Ciljna ploča za laser	SK105GD, SK106GD, SK209GD, SK312GD, SK700GD		
LE00855702	Laserski detektor	SK103,SK104,SK105,SK106, SK700D, SK700GD		
LE00870137	Zidni nosač za laser	SK103, SK104, SK105, SK106, SK700D, SK700GD		
P-81309	Aluminijumska merna letva 4m	SKR200Z, SKR102Z		
TK000ET03F	Držač	SK312GD, SK209GD		
TK0LDG301G	Prijemnik LDG-3	SK312GD, SK209GD		
TK0LDG501G	Prijemnik LDG-5	SK10GD, SK20GD, SK40GD, SK209GD, SK312GD		
TK0LEG2000	Naočare za laserske zrake	LD050P, LD080P, LD100P, SK102Z, SKR200Z, 103PZ, SK104Z		

Akumulat  
ori i  
punjači

Pribor za  
akumulat  
orske  
alate

Akumulat  
orske  
lampe i  
pribor

Pribor za  
laserske  
merače

Pribor za  
rušenje i  
udarno  
bušenje

Pribor za  
bušenje

Krunaste  
testere

Pribor za  
pritezani  
e

Pribor za  
sečenje i  
brusenje

Pribor za  
brusenje  
i  
poliranje

Pribor za  
profilisanj  
e i  
poravnaj

Pribor za  
višenam  
enski alat

Pribor za  
testere

Pribor za  
pneumat  
ske alate

Pribor za  
fenove  
za vrući  
vazduh

Pribor za  
usisivanj  
e

Pribor za  
alate za  
rad na  
otvoreno

Pribor za  
držače  
alata i  
zaštitna

Koferi i  
torbe

Ručni  
alati

Ostalo

Pribor za  
mješanje

# PRIBOR ZA RUŠENJE I UDARNO BUŠENJE

SDS-PLUS prihvati



SDS-MAX prihvati



cilindrični prihvati



GKW prihvati



13 mm šestougaoni prihvati



17 mm šestougaoni prihvati



19 mm šestougaoni prihvati



21 mm šestougaoni prihvati



28,6 mm šestougaoni prihvati



30 mm šestougaoni prihvati



1/4" šestougaoni prihvati



Armirani beton



Beton



Granit



Cigla



Krečnjak



Asfalt



Keramičke pločice



Drvo



Metali



Led



Za suhu upotrebu















Sakupljač prašine

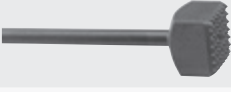

Malter





OBLIK:	NAMENA:	SDS -Plus	SDS -Max	17 mm Hex	19 mm Hex	21 mm Hex	28,6 mm Hex	30 mm Hex
<p>Samooštreći špic</p> 	Za rušenje, štemanje, izravnavanje u kamenu i betonu.		•				•	•
<p>Špic</p> 	Za rušenje, štemanje, izravnavanje u kamenu i betonu.	•	•	•	•	•	•	•
<p>Dleto</p> 	Za rušenje, štemovanje, obradu ivica, izradu kanala u zidu, kamenu ili betonu.	•	•	•	•	•	•	•
<p>Dleto za kanale</p> 	Izrada kanala u betonu.	•	•		•			
<p>Široko dleto</p> 	Za odstranjivanje ostataka od betona.	•	•	•	•	•	•	•
<p>Lopata za glinu</p> 	Za kopanje gline, tvrdog kamena, šljunka, zemlje.		•	•				•
<p>Nabijač</p> 	Za izravnanje površina, nabijanje asfalta ili kompresiju šljunka i zemlje.			•				•
<p>Ploča za rušenje</p> 	Za grubu obradu betona i asfalta.		•					
<p>Strugač</p> 	Za odtranjivanje lepka i čišćenje podloga.	•						
<p>Dleto za žljebove</p> 	Za radove u opeci i betonu. Podešavanje dubine kanala uz pomoć krilaca.	•	•					
<p>Dleto za pločice</p> 	Za odstranjivanje pločica kod renoviranja.	•	•					
<p>Dleto za malter</p> 	Za otklanjanje maltera i spojeva između cigli i pločica.		•					
<p>Dleto za drvo</p> 	Specijalno dleto za obradu drveta.	•						



## SDS-Plus POREĐENJE BURGIIJA

BURGIJA	STANDARD	VRH ZA CENTRIRANJE	STANDARD 4	V-PLUS	NEMESIS II
Klasa kvaliteta	★★	★★★	★★★	★★★★	★★★★★
Karbidna					
Vrh	2 rezna vrha	Vrh za centriranje i 2 rezna vrha	Vrh za centriranje i 4 rezna vrha	Vrh za centriranje i 2 rezna vrha	Vrh za centriranje i 4 rezna vrha
Vrsta spirale	Standardna dvostruka spirala	Standardna dvostruka spirala	Standardna dvostruka spirala	Dvostruka spirala velike izdržljivosti	Četvorostruka spirala velike izdržljivosti
Prečnik (ø)	3,5-30 mm	4-32 mm	5-25 mm	5-26 mm	5-32 mm
Brzina					
Radni vek					
Lakoća pozicioniranja					
Preciznost					
Zaštita od zaglavljivanja u armaturu					
Materijali					



## SDS-Max POREĐENJE BURGIIJA

BURGIJA	STANDARD	MAK4	ZA RUDARSTVO
Klasa kvaliteta	★★	★★★★	SPECIALIZED
Karbidna			
Vrh	2 rezna vrha	Vrh za centriranje i 4 rezna vrha	4 rezna vrha
Vrsta spirale	Standardna dvostruka spirala	Četvorostruka spirala velike izdržljivosti	Dvostruka spirala velike izdržljivosti
Prečnik (ø)	12-40 mm	12-52 mm	28-32 mm
Brzina			
Radni vek			
Lakoća pozicioniranja			
Preciznost			
Zaštita od zaglavljivanja u armaturu			
Materijali			

- Cigla
- Beton
- Armirani beton
- Granit

# NEMESIS II



## BURGIJE SDS-Plus NEMESIS II



**Ojačano**

Bočna ojačanja burgije omogućavaju sigurniji rad i visoku otpornost na habanje.

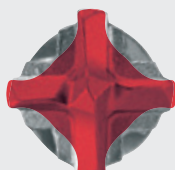

**Simetrične spirale**

4 simetrične spirale za ravnomerno izbacivanje prašine.



**Oblik žleba**

Geometrija velike zapremine zubaca obezbeđuje optimalno uklanjanje otpadaka od bušenja.



**Iskošene ivice**

Povećani žlijebni rubovi smanjuju rizik od pojačanog udara.

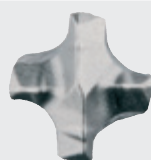

**5-16 mm Ø**

Vrh za centriranje olakšava bušenje sa malim odstupanjem zabušivanja.



**18-32 mm Ø**

Trodelni karbidni vrh burgije omogućava da se ne zaustavlja prilikom udarca u betonsku armaturu.



**Kruta spirala**

Kruta spirala smanjuje vibracije i povećava otpornost na lomove.



**Indikator istošenosti**

Indikator potrošenosti burgije.

**150%**

**Vek trajanja**

Duži vek trajanja od standardnih burgija.



## BURGIJE SDS-Plus V-PLUS

Zaoštreni zupci omogućuju veće brzine bušenja i veliku izdržljivost.



**Zaoštreni zupci**

Oblik spirale omogućava manje trenje i brzo uklanjanje prašine za brže bušenje.



**Nazubljene rezne ivice**

Ivice stvaraju mikro pukotine u materijalu tokom bušenja radi veće brzine bušenja.



**Poboljšani vrh za centriranje**

Vrh omogućava precizno bušenje i sprečava klizanje burgije na glatkim površinama.



**Iskošene ivice**

Prošireni obarači ivica za armature smanjuju rizik od kačenja armatura u betonu.

# NOVI SISTEM ZA IZVLAČENJE PRAŠINE

Nova serija burgija za izvlačenje prašine



Kompatibilna sa crevom  
Ø28 mm

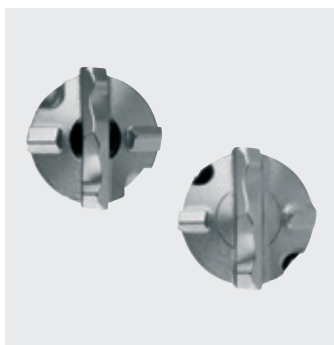

**TRODELNI VRH**  
Trodelni vrh olakšava bušenje  
čeličnih armatura u betonu.



**BURGIJA - USISIVAČ**  
Kompatibilan je sa većinom usisivača  
sa sistemom za usisavanje prašine.



**SVESTRANOST**  
Burgije za usisavanje prašine dostupne  
su sa SDS-Plus i SDS-Max prihvatom.



Za siguran rad obavezno držite crevo  
usisivača rukom ili ga naslonite  
na nogu da sprečite uvrtnje.

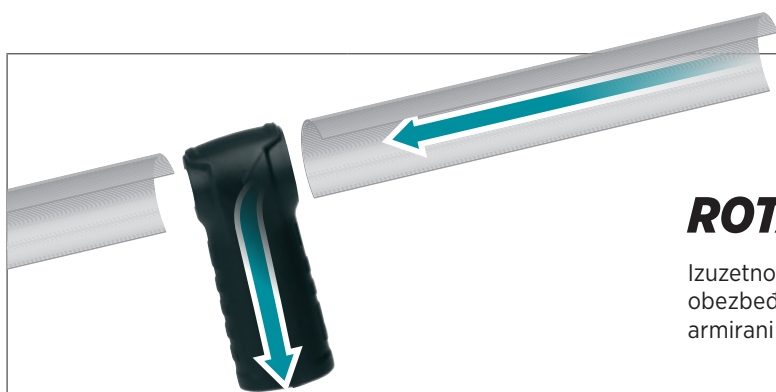

## ROTACIJA BEZ PRAŠINE

Izuzetno efikasno usisavanje prašine sa vrha bušilice  
obezbeđuje čisto radno mesto. Pogodno za beton i  
armirani beton.

### SDS-MAX

Model	Prečnik	Dužina	Radna dužina	Model	Prečnik	Dužina	Radna dužina
B-64428	16 mm	600 mm	400 mm	B-64490	28 mm	900 mm	700 mm
B-64434	18 mm	600 mm	400 mm	B-64509	30 mm	600 mm	400 mm
B-64440	20 mm	600 mm	400 mm	B-64515	30 mm	900 mm	700 mm
B-64456	22 mm	600 mm	400 mm	B-64537	32 mm	900 mm	700 mm
B-64462	24 mm	600 mm	400 mm	B-64521	32 mm	600 mm	400 mm
B-64478	25 mm	600 mm	400 mm	B-64543	35 mm	600 mm	400 mm
B-64484	28 mm	600 mm	400 mm	B-64559	35 mm	900 mm	700 mm

### SDS-PLUS

Model	Prečnik	Dužina	Radna dužina
B-64381	12 mm	200 mm	325 mm
B-64397	14 mm	240 mm	360 mm
B-64406	16 mm	240 mm	360 mm
B-64412	18 mm	240 mm	360 mm



# Pribor za rušenje i udarno bušenje

## Pribor za udarne alate sa SDS-Plus prihvatom

### Burgije SDS-Plus Nemesis II ★★★★★

Bušenje u armirani beton nije više nemoguća operacija, armatura nije prepreka za Nemesis II burgiju. Isto tako savršena je za primenu u najtvrdi prirodni kamen. Njena jedinstvena simetrična geometrija glave obezbeđuje izradu preciznih rupa. Savršena je za ankerno pričvršćenje i za tamo gde se traži obično bušenje. Nemesis II buši 50 % više rupa nego normalna burgija za rotirajući udarni čekić.

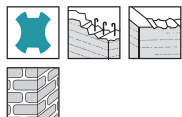

Model	Prečnik	Ukupna dužina	Radna dužina
B-57897	5 mm	115 mm	50 mm
B-57906	5 mm	165 mm	100 mm
B-57940	5,5 mm	115 mm	50 mm
B-57962	6 mm	115 mm	50 mm
B-57978	6 mm	165 mm	100 mm
B-57984	6 mm	215 mm	150 mm
B-57990	6 mm	265 mm	200 mm
B-58001	6 mm	315 mm	250 mm
B-58023	6,5 mm	165 mm	100 mm
B-58039	6,5 mm	215 mm	150 mm
B-58045	6,5 mm	265 mm	200 mm
B-58051	6,5 mm	315 mm	250 mm
B-58073	7 mm	165 mm	100 mm
B-58095	8 mm	115 mm	50 mm
B-58104	8 mm	165 mm	100 mm
B-58110	8 mm	215 mm	150 mm
B-58126	8 mm	265 mm	200 mm
B-58132	8 mm	315 mm	250 mm
B-58154	8 mm	465 mm	400 mm
B-58176	9 mm	165 mm	100 mm
B-58198	10 mm	115 mm	50 mm
B-58207	10 mm	165 mm	100 mm
B-58213	10 mm	215 mm	150 mm
B-58229	10 mm	265 mm	200 mm
B-58235	10 mm	315 mm	250 mm
B-58257	10 mm	455 mm	390 mm
B-58263	10 mm	600 mm	540 mm
B-58279	10 mm	1.000 mm	940 mm
E-14495	11 mm	165 mm	110 mm
E-14504	11 mm	215 mm	160 mm
E-14510	11 mm	265 mm	210 mm
E-14526	11 mm	315 mm	260 mm
E-14532	12 mm	165 mm	110 mm
E-14548	12 mm	215 mm	160 mm
E-14554	12 mm	265 mm	210 mm
E-14560	12 mm	315 mm	260 mm
E-14576	12 mm	455 mm	400 mm
E-14582	12 mm	600 mm	550 mm
E-14598	13 mm	165 mm	110 mm
E-14607	13 mm	215 mm	160 mm
E-14613	13 mm	265 mm	210 mm
E-14629	13 mm	315 mm	260 mm
E-14635	14 mm	165 mm	110 mm
E-14641	14 mm	215 mm	160 mm
E-14657	14 mm	265 mm	210 mm
E-14663	14 mm	315 mm	260 mm
E-14679	14 mm	455 mm	400 mm

E-14685	14 mm	600 mm	550 mm
E-14691	15 mm	165 mm	110 mm
E-14700	15 mm	215 mm	160 mm
E-14716	15 mm	265 mm	210 mm
E-14722	15 mm	155 mm	100 mm
E-14738	16 mm	165 mm	110 mm
E-14744	16 mm	215 mm	160 mm
E-14750	16 mm	265 mm	210 mm
E-14766	16 mm	315 mm	260 mm
E-14772	16 mm	455 mm	400 mm
E-14788	16 mm	600 mm	550 mm
B-58615	18 mm	250 mm	200 mm
B-58621	18 mm	450 mm	400 mm
B-58637	20 mm	250 mm	200 mm
B-58659	20 mm	450 mm	400 mm
B-58665	22 mm	250 mm	200 mm
B-58687	22 mm	450 mm	400 mm
B-58693	24 mm	250 mm	200 mm
B-58702	24 mm	450 mm	400 mm
B-58718	25 mm	250 mm	200 mm
B-58724	25 mm	450 mm	400 mm
B-58746	28 mm	250 mm	200 mm
B-58752	28 mm	450 mm	400 mm
B-58768	30 mm	250 mm	200 mm
B-58774	30 mm	450 mm	400 mm
B-58780	32 mm	450 mm	400 mm

### Kompleti burgija SDS-Plus Nemesis II ★★★★★

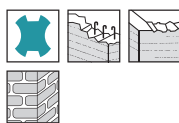

Model	Prečnik	Ukupna dužina	Jedinica (kom/kompl)
E-14794	12 mm	165 mm	5/1
E-14803	12 mm	215 mm	5/1
E-14819	12 mm	265 mm	5/1
E-14825	12 mm	165 mm	10/1
E-14831	12 mm	215 mm	10/1
E-14847	12 mm	265 mm	10/1
E-14853	12 mm	310 mm	10/1
E-14869	14 mm	165 mm	10/1
E-14875	14 mm	215 mm	10/1
E-14881	14 mm	265 mm	10/1
E-14897	14 mm	315 mm	10/1

### Burgije SDS-Plus V-Plus ★★★★★

V-Plus burgija postavlja nove standarde u performansama. Suženi zupci omogućuju veće brzine bušenja i veliku izdržljivost. Idealne su za korišćenje sa akumulatorskim udarnim bušilicama.

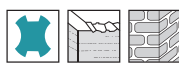

Model	Prečnik	Ukupna dužina	Radna dužina
B-46492	5 mm	110 mm	50 mm
B-46501	5 mm	160 mm	100 mm
B-47254	5 mm	140 mm	80 mm
B-60408	5 mm	450 mm	390 mm

Akumulat  
ori i  
punjači

Pribor za  
akumulat  
orske  
alate

Akumulat  
orske  
lampe i  
pribor

Pribor za  
laserske  
merace

Pribor za  
rušenje i  
udarno  
bušenje

Pribor za  
bušenje

Krunaste  
testere

Pribor za  
pritezani  
e

Pribor za  
sečenje i  
brusenje

Pribor za  
brusenje  
i  
poliranje

Pribor za  
profilisanje  
e i  
poravnava

Pribor za  
višenam  
enski alat

Pribor za  
testere

Pribor za  
pneumat  
ske alate

Pribor za  
fenove  
za vrući  
vazduh

Pribor za  
usisivani  
e

Pribor za  
alate za  
rad na  
otvoreno

Pribor za  
diržače  
alata i  
zaštitna

Koferi i  
torbe

Ručni  
alati

Ostalo

Pribor za  
mješanje

# Pribor za rušenje i udarno bušenje

Akumulat	B-46517	6 mm	110 mm	50 mm
ori i punjači	B-46523	6 mm	160 mm	100 mm
Pribor za akumulat	B-47341	6 mm	210 mm	150 mm
orske alate	B-47357	6 mm	260 mm	200 mm
Akumulat	B-47363	6 mm	310 mm	250 mm
orske lampe i pribor	B-47379	6 mm	460 mm	400 mm
Pribor za laserske	B-47391	6,5 mm	160 mm	100 mm
merace	B-47400	6,5 mm	210 mm	150 mm
Pribor za rušenje i udarno bušenje	B-47416	6,5 mm	260 mm	200 mm
Pribor za bušenje	B-47422	6,5 mm	310 mm	250 mm
Krunaste testere	B-47438	7 mm	110 mm	50 mm
Pribor za pritezanje	B-47444	7 mm	160 mm	100 mm
ce	B-46539	8 mm	110 mm	50 mm
Pribor za sečenje i brušenje	B-46545	8 mm	160 mm	100 mm
Pribor za brušenje i poliranje	B-47472	8 mm	210 mm	150 mm
Pribor za profilisanje i poravnavanje	B-47488	8 mm	260 mm	200 mm
Pribor za višenamenski alat	B-47503	8 mm	400 mm	340 mm
Pribor za testere	B-47519	8 mm	460 mm	400 mm
Pribor za pneumatike alate	B-47525	8 mm	600 mm	540 mm
Pribor za feneve za usisivanje	B-47531	9 mm	160 mm	100 mm
Pribor za alate za rad na otvoreno	B-47547	9 mm	210 mm	150 mm
Pribor za držače alata i zaštitna	B-47553	9,5 mm	160 mm	100 mm
Koferi i torbe	B-51409	9,5 mm	310 mm	250 mm
Ručni alati	B-46551	10 mm	110 mm	50 mm
Ostalo	B-46567	10 mm	160 mm	100 mm
Pribor za mješanje	B-47569	10 mm	210 mm	150 mm
	B-47575	10 mm	260 mm	200 mm
	B-47581	10 mm	310 mm	250 mm
	B-47597	10 mm	350 mm	290 mm
	B-47606	10 mm	450 mm	390 mm
	B-47612	10 mm	600 mm	540 mm
	B-47628	10 mm	800 mm	740 mm
	B-47634	10 mm	1.000 mm	940 mm
	B-47656	11 mm	210 mm	160 mm
	B-47662	11 mm	260 mm	210 mm
	B-46573	12 mm	160 mm	100 mm
	B-47684	12 mm	210 mm	160 mm
	B-47690	12 mm	260 mm	210 mm
	B-47715	12 mm	360 mm	310 mm
	B-47721	12 mm	450 mm	400 mm
	B-47737	12 mm	600 mm	550 mm
	B-47743	12 mm	800 mm	740 mm
	B-47759	12 mm	1.000 mm	950 mm
	B-47765	13 mm	160 mm	110 mm
	B-47771	13 mm	210 mm	160 mm
	B-47787	13 mm	260 mm	210 mm
	B-47793	13 mm	310 mm	260 mm
	B-46589	14 mm	160 mm	110 mm
	B-47802	14 mm	210 mm	160 mm
	B-47818	14 mm	260 mm	210 mm
	B-47830	14 mm	450 mm	400 mm
	B-47846	14 mm	600 mm	550 mm
	B-47852	14 mm	1.000 mm	950 mm
	B-47868	15 mm	160 mm	110 mm
	B-47874	15 mm	210 mm	160 mm
	B-47880	15 mm	260 mm	210 mm
	B-47896	15 mm	450 mm	400 mm
	B-47905	16 mm	160 mm	110 mm
	B-47911	16 mm	210 mm	160 mm
	B-47927	16 mm	260 mm	210 mm
	B-47933	16 mm	310 mm	260 mm
	B-47949	16 mm	450 mm	400 mm
	B-47955	16 mm	600 mm	550 mm

B-47961	16 mm	800 mm	750 mm
B-47977	16 mm	1.000 mm	950 mm
B-47983	17 mm	210 mm	160 mm
B-47999	17 mm	450 mm	400 mm
B-48000	18 mm	200 mm	150 mm
B-48016	18 mm	300 mm	250 mm
B-48022	18 mm	450 mm	400 mm
B-48038	18 mm	600 mm	550 mm
B-48044	18 mm	1.000 mm	950 mm
B-48050	19 mm	200 mm	150 mm
B-48066	19 mm	450 mm	400 mm
B-48072	20 mm	200 mm	150 mm
B-48088	20 mm	300 mm	250 mm
B-48094	20 mm	450 mm	400 mm
B-48103	20 mm	600 mm	550 mm
B-48119	20 mm	800 mm	750 mm
B-48125	20 mm	1.000 mm	950 mm
B-48131	22 mm	250 mm	200 mm
B-48147	22 mm	450 mm	400 mm
B-48153	22 mm	600 mm	550 mm
B-48169	22 mm	1.000 mm	950 mm
B-48175	23 mm	250 mm	200 mm
B-48181	23 mm	450 mm	400 mm
B-48197	24 mm	250 mm	200 mm
B-48206	24 mm	450 mm	400 mm
B-48212	24 mm	600 mm	550 mm
B-48234	25 mm	450 mm	400 mm
B-48240	25 mm	600 mm	550 mm
B-48256	25 mm	1.000 mm	950 mm
B-48262	26 mm	250 mm	200 mm
B-48278	26 mm	450 mm	400 mm

## TCT burgije sa 4 rezna vrha za SDS-Plus ★★★

Vrh od volfram karbida sa 4 rezna vrha Zaštita od zaglavljivanja u armaturu Dobra preciznost bušenja obezbeđuje glatku i ujednačenu rupu Podesno za korišćenje pri radu sa armiranim betonom

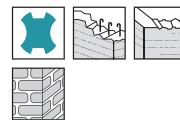

Model	Prečnik	Ukupna dužina	Radna dužina
B-68127	5 mm	110 mm	50 mm
B-68133	5 mm	160 mm	100 mm
B-68149	5 mm	210 mm	150 mm
B-68155	5 mm	260 mm	200 mm
B-62496	6 mm	110 mm	50 mm
B-62505	6 mm	160 mm	100 mm
B-62511	6 mm	210 mm	150 mm
B-62527	6 mm	260 mm	200 mm
B-68161	6 mm	310 mm	250 mm
B-62533	6,5 mm	110 mm	50 mm
B-62549	6,5 mm	160 mm	100 mm
B-62555	6,5 mm	210 mm	150 mm
B-62561	6,5 mm	260 mm	200 mm
B-62577	7 mm	110 mm	50 mm
B-62583	7 mm	160 mm	100 mm
B-62599	7 mm	210 mm	150 mm
B-62608	8 mm	110 mm	50 mm
B-62614	8 mm	160 mm	100 mm
B-62620	8 mm	210 mm	150 mm

# Pribor za rušenje i udarno bušenje

B-62636	8 mm	260 mm	200 mm
B-62642	8 mm	310 mm	250 mm
B-62658	8 mm	460 mm	400 mm
B-62664	10 mm	110 mm	50 mm
B-62670	10 mm	160 mm	100 mm
B-62686	10 mm	210 mm	150 mm
B-62692	10 mm	260 mm	200 mm
B-62701	10 mm	310 mm	250 mm
B-62717	10 mm	350 mm	290 mm
B-62723	10 mm	460 mm	400 mm
B-62739	12 mm	160 mm	100 mm
B-62745	12 mm	210 mm	150 mm
B-62751	12 mm	260 mm	200 mm
B-62767	12 mm	310 mm	250 mm
B-62773	12 mm	350 mm	290 mm
B-62789	12 mm	460 mm	400 mm
B-62795	14 mm	160 mm	100 mm
B-62804	14 mm	210 mm	150 mm
B-62810	14 mm	260 mm	200 mm
B-62826	14 mm	310 mm	250 mm
B-62832	14 mm	350 mm	290 mm
B-62848	14 mm	460 mm	400 mm
B-62854	16 mm	160 mm	100 mm
B-62860	16 mm	210 mm	150 mm
B-62876	16 mm	260 mm	200 mm
B-62882	16 mm	310 mm	250 mm
B-62898	16 mm	350 mm	290 mm
B-62907	16 mm	460 mm	400 mm
B-68177	18 mm	260 mm	200 mm
B-68236	18 mm	460 mm	400 mm
B-68183	20 mm	260 mm	200 mm
B-68242	20 mm	460 mm	400 mm
B-68199	22 mm	260 mm	200 mm
B-68258	22 mm	460 mm	400 mm
B-68208	25 mm	260 mm	200 mm
B-68264	25 mm	460 mm	400 mm

B-55952	8 mm	210 mm	150 mm
B-55968	8 mm	260 mm	200 mm
B-67848	8 mm	310 mm	250 mm
B-67854	8 mm	400 mm	340 mm
B-68046	8 mm	460 mm	400 mm
B-55974	9 mm	160 mm	100 mm
B-67860	9 mm	210 mm	150 mm
B-54190	10 mm	160 mm	100 mm
B-54209	10 mm	210 mm	150 mm
B-55980	10 mm	110 mm	50 mm
B-55996	10 mm	260 mm	200 mm
B-56007	10 mm	310 mm	250 mm
B-56013	10 mm	460 mm	400 mm
B-67876	10 mm	350 mm	290 mm
B-67882	11 mm	160 mm	100 mm
B-67898	11 mm	210 mm	150 mm
B-67907	11 mm	260 mm	200 mm
B-54215	12 mm	160 mm	100 mm
B-54221	12 mm	210 mm	150 mm
B-56029	12 mm	260 mm	200 mm
B-56035	12 mm	350 mm	290 mm
B-56041	12 mm	460 mm	400 mm
B-67913	12 mm	310 mm	250 mm
B-56057	13 mm	160 mm	100 mm
B-67929	13 mm	210 mm	150 mm
B-67935	13 mm	260 mm	200 mm
B-56063	14 mm	160 mm	100 mm
B-56079	14 mm	210 mm	150 mm
B-56085	14 mm	260 mm	200 mm
B-56091	14 mm	350 mm	290 mm
B-56100	14 mm	460 mm	400 mm
B-56116	16 mm	160 mm	100 mm
B-56122	16 mm	210 mm	150 mm
B-56138	16 mm	310 mm	250 mm
B-56144	16 mm	350 mm	290 mm
B-56150	16 mm	460 mm	400 mm
B-56465	17 mm	210 mm	150 mm
B-56471	17 mm	350 mm	290 mm
B-62125	18 mm	210 mm	150 mm
B-62131	18 mm	350 mm	290 mm
B-62147	19 mm	210 mm	150 mm
B-62153	19 mm	350 mm	290 mm
B-62169	20 mm	210 mm	150 mm
B-62175	20 mm	350 mm	290 mm
B-62181	22 mm	210 mm	150 mm
B-62197	22 mm	350 mm	290 mm
B-62206	24 mm	210 mm	150 mm
B-62212	24 mm	350 mm	290 mm
B-62228	25 mm	210 mm	150 mm
B-62234	25 mm	350 mm	290 mm
B-62240	28 mm	210 mm	150 mm
B-62256	28 mm	350 mm	290 mm
B-62262	30 mm	210 mm	150 mm
B-62278	30 mm	350 mm	290 mm
B-62284	32 mm	350 mm	290 mm

## Burgije SDS-Plus sa centrirnim vrhom ★★★



Model	Prečnik	Ukupna dužina	Radna dužina
B-55859	4 mm	110 mm	50 mm
B-54128	5 mm	110 mm	50 mm
B-54134	5 mm	160 mm	100 mm
B-55865	5,5 mm	110 mm	50 mm
B-55871	5,5 mm	160 mm	100 mm
B-54140	6 mm	110 mm	50 mm
B-54156	6 mm	160 mm	100 mm
B-54162	6 mm	210 mm	150 mm
B-67832	6 mm	260 mm	200 mm
B-55887	6,5 mm	110 mm	50 mm
B-55893	6,5 mm	160 mm	50 mm
B-55902	6,5 mm	210 mm	150 mm
B-55918	6,5 mm	260 mm	200 mm
B-55924	7 mm	110 mm	50 mm
B-55930	7 mm	160 mm	100 mm
B-55946	7 mm	210 mm	150 mm
B-54178	8 mm	110 mm	50 mm
B-54184	8 mm	160 mm	100 mm

Akumulat orni i punjači  
Pribor za akumulat orske alatke  
Akumulat orske lampe i pribor  
Pribor za laserske merace  
Pribor za rušenje i udarno bušenje  
Pribor za bušenje  
Krunaste testere  
Pribor za pritezanje  
Pribor za sečenje i brušenje  
Pribor za brušenje i poliranje  
Pribor za profilisanje i poravnanje  
Pribor za višenamenski alat  
Pribor za testere  
Pribor za pneumatike alatke  
Pribor za fenove za vrući vazduh  
Pribor za usisivanje  
Pribor za alate za rad na otvoreno  
Pribor za držače alata i zaštitna  
Koferi i torbe  
Ručni alati  
Ostalo  
Pribor za mješanje

# Pribor za rušenje i udarno bušenje

## Burgije SDS-Plus Standard

★★

2 rezna SDS-plus burgija pogodna za malter i beton. Karbidni vrh sa centralnom tačkom i optimizovani zupci nude bušenje sa velikim brzinama i nisku cenu. TCT vrh proizveden prema DIN 8039 dostupan je za prečnike od 3,5 do 30 mm.



Model	Prečnik	Ukupna dužina	Radna dužina
D-16950	3,5 mm	90 mm	30 mm
D-00016	4 mm	110 mm	50 mm
D-00022	5 mm	110 mm	50 mm
D-00038	5 mm	160 mm	100 mm
D-00044	5,5 mm	110 mm	50 mm
D-00050	6 mm	110 mm	50 mm
D-00066	6 mm	160 mm	100 mm
D-00072	6 mm	210 mm	150 mm
D-00088	6,5 mm	110 mm	50 mm
D-00094	6,5 mm	160 mm	100 mm
D-45082	6,5 mm	210 mm	150 mm
D-00103	7 mm	110 mm	50 mm
D-00119	7 mm	160 mm	100 mm
D-00125	8 mm	110 mm	50 mm
D-00131	8 mm	160 mm	100 mm
D-00147	8 mm	210 mm	150 mm
D-00153	8 mm	260 mm	200 mm
D-00169	9 mm	210 mm	150 mm
D-08056	9 mm	160 mm	100 mm
D-00175	10 mm	160 mm	100 mm
D-00181	10 mm	210 mm	150 mm
D-00197	10 mm	260 mm	200 mm
D-00206	10 mm	310 mm	250 mm
D-17538	10 mm	460 mm	400 mm
D-00212	11 mm	160 mm	100 mm
D-00228	12 mm	160 mm	100 mm
D-00234	12 mm	210 mm	150 mm
D-00240	12 mm	260 mm	200 mm
D-16271	12 mm	460 mm	400 mm
D-00256	13 mm	160 mm	100 mm
D-00262	14 mm	160 mm	100 mm
D-00278	14 mm	260 mm	200 mm
D-17544	14 mm	460 mm	400 mm
D-00284	15 mm	160 mm	100 mm
D-17550	15 mm	460 mm	400 mm
D-00290	16 mm	210 mm	150 mm
D-00309	16 mm	310 mm	250 mm
D-16287	16 mm	460 mm	400 mm
D-00315	17 mm	210 mm	150 mm
D-00321	18 mm	210 mm	150 mm
D-00337	18 mm	300 mm	240 mm
D-16221	18 mm	350 mm	245 mm
D-17566	18 mm	460 mm	400 mm
D-00343	19 mm	210 mm	150 mm
D-16293	19 mm	460 mm	400 mm
D-00359	20 mm	210 mm	150 mm
D-00365	20 mm	310 mm	250 mm
D-15235	20 mm	460 mm	400 mm
D-00371	22 mm	260 mm	200 mm
D-08062	22 mm	310 mm	250 mm
D-15241	22 mm	460 mm	400 mm
D-16302	24 mm	460 mm	400 mm
D-00387	25 mm	260 mm	200 mm

D-08517	25 mm	310 mm	250 mm
D-15257	25 mm	460 mm	400 mm
D-00393	26 mm	260 mm	200 mm
D-08078	26 mm	310 mm	250 mm
D-15263	26 mm	460 mm	400 mm
D-16318	28 mm	460 mm	400 mm
D-17572	30 mm	460 mm	400 mm

## Burgije SDS-Plus za drvo

★★★



Model	Prečnik	Ukupna dužina	Radna dužina
B-57489	4 mm	105 mm	43 mm
B-57495	5 mm	116 mm	52 mm
B-57504	6 mm	123 mm	57 mm
B-57510	8 mm	147 mm	75 mm
B-57526	10 mm	163 mm	87 mm

## Burgije SDS-Plus za metal

★★★★



Model	Prečnik	Ukupna dužina	Radna dužina
B-57401	3 mm	90 mm	33 mm
B-57417	3,5 mm	100 mm	39 mm
B-57423	4 mm	105 mm	43 mm
B-57439	4,5 mm	110 mm	47 mm
B-57445	5 mm	116 mm	52 mm
B-57451	5,5 mm	123 mm	57 mm
B-57467	6 mm	123 mm	57 mm
B-57473	6,5 mm	131 mm	63 mm

## Burgije SDS-Plus 4-Plus za led **SPECIALIZED**



Model	Prečnik	Ukupna dužina	Radna dužina
821700-1	32 mm	450 mm	400 mm

# Pribor za rušenje i udarno bušenje

## Pribor za udarne alate sa SDS-Plus prihvatom

### SDS-Plus šiljata dleta



Model	Širina	Ukupna dužina
D-71249		230 mm
B-64294		250 mm
P-05505		250 mm
P-25068		250 mm
D-19015		400 mm

### SDS-Plus šiljata dleta - PREMIUM



Model	Širina	Ukupna dužina
B-64238		250 mm

### SDS-Plus ravna dleta



Model	Širina	Ukupna dužina
D-71255	20 mm	160 mm
D-71261	20 mm	230 mm
B-64303	20 mm	250 mm
P-05511	20 mm	250 mm
P-25074	20 mm	250 mm
D-19021	20 mm	400 mm

### SDS-Plus ravna dleta - PREMIUM



Model	Širina	Ukupna dužina
B-64244	20 mm	250 mm

### SDS-Plus pljosnata dleta



Model	Širina	Ukupna dužina
D-61042	80 mm	150 mm
A-30483	40 mm	200 mm

P-05527	40 mm	200 mm
P-24941*	40 mm	200 mm
D-71277	40 mm	230 mm
B-64319	40 mm	250 mm
D-61020	80 mm	250 mm
P-24935	60 mm	250 mm
P-24957*	60 mm	250 mm

\*Ukrivljeno

### SDS-Plus pljosnata dleta - PREMIUM



Model	Širina	Ukupna dužina
B-64250	40 mm	250 mm

### SDS-Plus dleta za žljebove

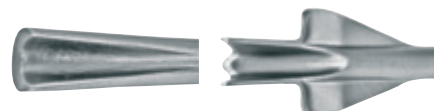

Model	Širina	Ukupna dužina
P-25080	22 mm	240 mm
P-05533	22 mm	250 mm
P-24963*	22 mm	250 mm

\*Sa vodećim krilima

### SDS-Plus strugač



Model	Dimenzija	Opis
A-68161	100 x 160 mm	Strugač
343411-9	100 mm	Rezervni strugač

### SDS-Plus dleta za pločice



Model	Širina	Ukupna dužina
B-14071	40 mm	260 mm
P-63987	40 mm	260 mm

Akumulat  
ori i  
punjači

Pribor za  
akumulat  
orske  
alate

Akumulat  
orske  
lampe i  
pribor

Pribor za  
laserske  
merace

Pribor za  
rušenje i  
udarno  
bušenje

Pribor za  
bušenje

Krunaste  
testere

Pribor za  
pritezani  
e

Pribor za  
sečenje i  
brusenje

Pribor za  
brusenje i  
poliranje

Pribor za  
profilisanje  
i  
poravnava

Pribor za  
višenam  
enski alat

Pribor za  
testere

Pribor za  
pneumat  
ske alate

Pribor za  
fenove  
za vrući  
vazduh

Pribor za  
usisivanje

Pribor za  
alate za  
rad na  
otvoreno

Pribor za  
držače  
alata i  
zaštitna

Koferi i  
torbe

Ručni  
alati

Ostalo

Pribor za  
mješanje

## SDS-Plus dleta za drvo

Model	Širina	Ukupna dužina
P-25105	20 mm	170 mm
P-25111	30 mm	170 mm

## Krunaste burgije SDS-Plus

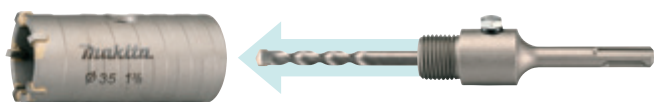

### Krunaste burgije SDS-Plus

Univerzalna krunasta burgija, pogodna za vodoinstalatore, električare, stolare i opšte graditelje. Može da seče široki spektar materijala, uključujući cigle, gipsane ploče, plastiku, melamin, tvrdo drvo, ivericu i vlaknaste ploče srednje gustine (MDF). Stabilna i dugotrajna, sa jakim zupcima od tvrdog metala, daje odlične rezultate.

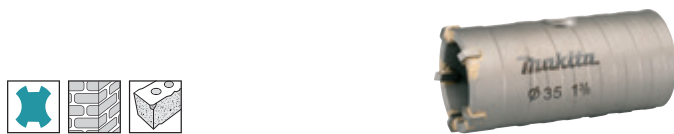

Model	Prečnik	Ukupna dužina	Dubina bušenja
D-73891	30 mm	72 mm	50 mm
D-73900	35 mm	72 mm	50 mm
D-73916	40 mm	72 mm	50 mm
D-73922	50 mm	72 mm	50 mm
D-73938	68 mm	72 mm	50 mm
D-73944	82 mm	72 mm	50 mm
D-73950	90 mm	72 mm	50 mm
D-73966	100 mm	72 mm	50 mm

### SDS-Plus centralna burgija za krunastu burgiju



Model	Prečnik	Ukupna dužina	Dubina bušenja
D-73972	8 mm	110 mm	60 mm

### Adapter SDS-Plus za krunaste burgije



Model	Prečnik	Ukupna dužina	Dubina bušenja
D-73988	/	110 mm	/
D-73994	/	200 mm	/
D-74005	/	350 mm	/

## SDS-Plus set krunaste burgije



Model	Prečnik	Ukupna dužina	Dubina bušenja
D-74011	68 mm	182 mm	50 mm
D-74027	82 mm	182 mm	50 mm

## Stezne glave i adapteri SDS-Plus

### Brzoizmenljive cilindrične glave



Model	Za model
191F46-4	HR3012FCJ
194079-2	DHR243, HR2450FT, HR2450T, HR2470FT, HR2470T, HR2610T, HR2611FT, HR2630T, HR2631FT, HR2651T, HR2653T, HR2810T, HR2811FT
194568-7	HR3210FCT
196173-6	HR2630T, HR2631FT
199139-5	DHR281, DHR283, HR002G, HR004G

### Brzoizmenljive SDS-Plus glave



Model	Za model
125420-8	HR3210FCT
191F47-2	HR3011FCJ, HR3012FC
194080-7	DHR243, HR2450FT, HR2450T, HR2470FT, HR2470T, HR2610T, HR2611FT, HR2630T, HR2631FT, HR2651T, HR2653T, HR2810T, HR2811FT
199138-7	DHR281, DHR283, HR002G, HR004G

### Adapteri SDS-Plus



Model	Navoj	Specijalnost
122573-4	1/2" - 20 UNF	
D-14093	1/2" - 20 UNF	Nije za udarno bušenje

# Pribor za rušenje i udarno bušenje

## Adapter SDS-Plus sa nazubljenim vencem



Model	Vpetje	Ima stezni ključ
122574-2	SDS-Plus - 13 mm	Ne
P-34833	SDS-Plus - 13 mm	Da

## Adapter SDS-Plus za 1/4" burgije



Model	Dolžina	Prihvati
P-21646	78 mm	1/4"

## Brzostezni držač bita, SDS-Plus



Model	Dolžina	Prihvati
B-57548	80 mm	1/4"

## Pribor za udarne alate sa SDS-MAX prihvatom

### Burgije SDS-MAX MAK4 ★★★★★

Premium SDS-MAX burgija sa dinamičnom 4-reznom glavom. Simetrična geometrija glave, sa centriranim vrhom, za optimizovane rezultate u slučaju sudara sa armaturom. Skraćena spirala i konusan odvođač prašine za ekstra brzo odvođenje materijala kroz dvojne zupce, sa velikom zapreminom. MAK4 značajno povećava performanse brzine bušenja i životni vek. Prečnici od 12 - 15 mm su sa 2-zupca.

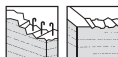

Model	Prečnik	Ukupna dužina	Radna dužina
P-17033	12 mm	340 mm	200 mm
P-17049	12 mm	540 mm	400 mm
P-17055	12 mm	690 mm	550 mm
P-17077	14 mm	340 mm	200 mm
P-17083	14 mm	540 mm	400 mm
P-17108	15 mm	340 mm	200 mm
P-17114	15 mm	540 mm	400 mm
P-77730	16 mm	340 mm	200 mm
P-77746	16 mm	540 mm	400 mm
P-77752	16 mm	940 mm	800 mm
P-77768	16 mm	1320 mm	1180 mm
P-77774	18 mm	340 mm	200 mm

P-77780	18 mm	540 mm	400 mm
P-77796	18 mm	940 mm	800 mm
P-77805	18 mm	1320 mm	1180 mm
P-77811	20 mm	320 mm	200 mm
P-77827	20 mm	520 mm	400 mm
P-77833	20 mm	920 mm	800 mm
P-77849	20 mm	1320 mm	1200 mm
P-77855	22 mm	320 mm	200 mm
P-77861	22 mm	520 mm	400 mm
P-77877	22 mm	920 mm	800 mm
P-77883	22 mm	1320 mm	1200 mm
P-77899	24 mm	320 mm	200 mm
P-77908	24 mm	520 mm	400 mm
P-77914	25 mm	320 mm	200 mm
P-77920	25 mm	520 mm	400 mm
P-77936	25 mm	920 mm	800 mm
P-77942	25 mm	1320 mm	1180 mm
P-77958	26 mm	520 mm	400 mm
P-77964	28 mm	370 mm	250 mm
P-77970	28 mm	570 mm	450 mm
P-77986	28 mm	670 mm	550 mm
P-77992	28 mm	920 mm	800 mm
P-78003	28 mm	1320 mm	1200 mm
P-78019	30 mm	370 mm	250 mm
P-78025	30 mm	570 mm	450 mm
P-78031	32 mm	370 mm	250 mm
P-78047	32 mm	570 mm	450 mm
P-78053	32 mm	920 mm	800 mm
P-78069	32 mm	1320 mm	1200 mm
P-78075	35 mm	370 mm	250 mm
P-78081	35 mm	570 mm	450 mm
P-78097	35 mm	670 mm	550 mm
P-78592	35 mm	1320 mm	1200 mm
P-78106	37 mm	370 mm	250 mm
P-78112	37 mm	570 mm	450 mm
P-78128	37 mm	920 mm	800 mm
P-78134	38 mm	370 mm	250 mm
P-78140	38 mm	570 mm	450 mm
P-78156	40 mm	370 mm	250 mm
P-78162	40 mm	570 mm	450 mm
P-78178	40 mm	920 mm	800 mm
P-78184	40 mm	1320 mm	1200 mm
P-78190	45 mm	570 mm	450 mm
P-78209	45 mm	920 mm	800 mm
P-78215	50 mm	570 mm	450 mm
P-78221	52 mm	570 mm	450 mm

## TCT burgija za beton sa četiri pera SDS MAX ★★★

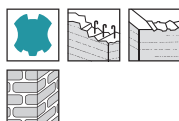

Model	Prečnik	Ukupna dužina	Radna dužina
E-11324	12 mm	340 mm	200 mm
E-11330	12 mm	540 mm	400 mm
E-11346	14 mm	340 mm	200 mm
E-11352	14 mm	540 mm	400 mm
E-11368	16 mm	340 mm	200 mm

Akumulat  
ori i  
punjači

Pribor za  
akumulat  
orske  
alate

Akumulat  
orske  
lampe i  
pribor

Pribor za  
laserske  
merace

Pribor za  
rušenje i  
udarno  
bušenje

Pribor za  
bušenje

Krunaste  
testere

Pribor za  
pritezani  
e

Pribor za  
sečenje i  
brusjenje

Pribor za  
brusjenje  
i  
poliranje

Pribor za  
profilisanje  
i  
poravnane

Pribor za  
višenam  
enski alat

Pribor za  
testere

Pribor za  
pneumat  
ske alate

Pribor za  
fenove  
za vrući  
vazduh

Pribor za  
usisivani  
e

Pribor za  
alate za  
rad na  
otvoreno

Pribor za  
diržače  
alata i  
zaštitna

Koferi i  
torbe

Ručni  
alati

Ostalo

Pribor za  
mješanje

# Pribor za rušenje i udarno bušenje

E-11374	16 mm	540 mm	400 mm
E-11380	18 mm	340 mm	200 mm
E-11396	18 mm	540 mm	400 mm
E-11405	20 mm	340 mm	200 mm
E-11411	20 mm	540 mm	400 mm
E-11427	22 mm	340 mm	200 mm
E-11433	22 mm	540 mm	400 mm
E-11449	24 mm	340 mm	200 mm
E-11455	24 mm	540 mm	400 mm
E-11461	25 mm	340 mm	200 mm
E-11477	25 mm	540 mm	400 mm
E-11483	28 mm	370 mm	250 mm
E-11499	28 mm	570 mm	450 mm
E-11508	30 mm	370 mm	250 mm
E-11514	30 mm	570 mm	450 mm

## Burgije SDS-MAX ZENTRO za rudarstvo

**SPECIALIZED**

Karbidni vrh sa geometrijom SDS-MAX ZENTRO za rudarstvo je krajnje stabilan. On je otporan i efikasan čak i u najtežim uslovima. SDS-MAX ZENTRO buši do 25% duže u prirodnom kamenu, u poređenju sa standardnim SDS-MAX udarnim burgijama. Bočni karbid podržava glavni karbid, zahvaljujući simetriji 4x90°.



Model	Prečnik	Ukupna dužina	Radna dužina
B-15039	28 mm	670 mm	550 mm
B-14613	32 mm	570 mm	450 mm
B-15045	32 mm	920 mm	800 mm

## Burgije SDS-MAX Standard

★★

2-rezne SDS-MAX burgije su pogodne za malter i beton. Tvrdi karbidni vrh sa centralnom tačkom i optimizovani zupci nude velike brzine bušenja. Burgije su sa prečnicima od 12 do 40 mm.



Model	Prečnik	Ukupna dužina	Radna dužina
D-33875	12 mm	340 mm	200 mm
D-33881	12 mm	540 mm	400 mm
D-33897	14 mm	340 mm	200 mm
D-33906	14 mm	540 mm	400 mm
D-33912	15 mm	340 mm	200 mm
D-33928	15 mm	540 mm	400 mm
D-33934	16 mm	340 mm	200 mm
D-33940	16 mm	540 mm	400 mm
D-33956	18 mm	340 mm	200 mm
D-33962	18 mm	540 mm	400 mm
D-33978	20 mm	340 mm	200 mm
D-33984	20 mm	540 mm	400 mm
D-33990	22 mm	340 mm	200 mm
D-34001	22 mm	540 mm	400 mm
D-34017	24 mm	340 mm	200 mm
D-34023	24 mm	540 mm	400 mm
D-34039	25 mm	340 mm	200 mm
D-34045	25 mm	540 mm	400 mm
D-34051	28 mm	370 mm	250 mm
D-34067	28 mm	570 mm	450 mm
D-34073	30 mm	370 mm	250 mm
D-34089	30 mm	570 mm	450 mm
D-34095	32 mm	370 mm	250 mm
D-34104	32 mm	570 mm	450 mm
D-34110	35 mm	370 mm	250 mm
D-34126	35 mm	570 mm	450 mm
D-34132	38 mm	370 mm	250 mm
D-34148	38 mm	570 mm	450 mm
D-34154	40 mm	370 mm	250 mm
D-34160	40 mm	570 mm	450 mm

## Krunaste burgije za beton SDS-MAX

★★★★

Makita krunaste burgije za bušenje u opsegu od 45-80 mm u betonu, kamenu, prirodnom kamenu. Sa centriranjem od tvrdog metala, postiže se brzo bušenje. Mala težina krune omogućava brzo uklanjavanje materijala. Pogodna je za kombinovani čekić iz klase od 8 kg. Jednodielna konstrukcija.



Model	Prečnik	Ukupna dužina	Radna dužina
B-57629	40 mm	550 mm	450 mm
B-57635	45 mm	550 mm	450 mm
B-57641	45 mm	990 mm	850 mm
B-57657	55 mm	550 mm	450 mm
B-57663	55 mm	990 mm	850 mm
B-57679	65 mm	550 mm	450 mm
B-57685	65 mm	990 mm	850 mm
B-57691	80 mm	550 mm	450 mm
B-57700	80 mm	990 mm	850 mm

## Zabijač klinova SDS-MAX



Model	Prečnik	Ukupna dužina
E-13029	13,3 mm	260 mm
E-13035	16,5 mm	260 mm
E-13041	22,2 mm	260 mm



## Dleta SDS-MAX

### SDS-MAX šiljata dleta



Model	Širina	Ukupna dužina
P-16237	/	280 mm
D-34176	/	300 mm
B-64325	/	400 mm
D-34182	/	400 mm
P-16243	/	400 mm
D-34198	/	600 mm
P-16259	/	600 mm

### SDS-MAX šiljata dleta - samooštreća

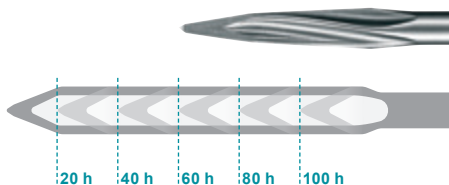

Model	Širina	Ukupna dužina
B-10366	/	400 mm
B-23064	/	400 mm

### SDS-MAX šiljata dleta - PREMIUM



Model	Širina	Ukupna dužina
B-64266	/	400 mm

### SDS-MAX dleta



Model	Širina	Ukupna dužina
P-16265	25 mm	280 mm
D-34207	25 mm	300 mm
B-64331	25 mm	400 mm
D-34213	25 mm	400 mm
P-16271	25 mm	400 mm
D-34229	25 mm	600 mm
P-16287	25 mm	600 mm

### SDS-MAX dleta - samooštreća



Model	Širina	Ukupna dužina
B-14015	50 mm	350 mm

### SDS-MAX dleta - PREMIUM



Model	Širina	Ukupna dužina
B-64272	25 mm	400 mm

### SDS-MAX pljosnata dleta



Model	Širina	Ukupna dužina
D-34241	80 mm	300 mm
P-16318	80 mm	300 mm
P-16302	50 mm	360 mm
B-64347	50 mm	380 mm
D-34235	50 mm	400 mm

### SDS-MAX pljosnata dleta - PREMIUM



Model	Širina	Ukupna dužina
B-64288	50 mm	400 mm

### SDS-MAX dleta za žljebove

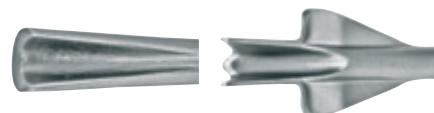

Model	Širina	Ukupna dužina
P-16293	26 mm	300 mm
P-16330*	35 mm	380 mm

\*Sa vodećim krilima

Akumulat orni punjači  
 Pribor za akumulat orske alat  
 Akumulat orske lampe i pribor  
 Pribor za laserske merace  
 Pribor za rušenje i udarno bušenje  
 Pribor za bušenje  
 Krunaste testere  
 Pribor za pritezanje  
 Pribor za sečenje i brušenje  
 Pribor za brušenje i poliranje  
 Pribor za profilisanje i poravnanje  
 Pribor za višenamenski alat  
 Pribor za testere  
 Pribor za pneumatske alat  
 Pribor za fenove za vrući vazduh  
 Pribor za usisivanje  
 Pribor za alate za rad na otvoreno  
 Pribor za držače alata i zaštitna  
 Koferi i torbe  
 Ručni alati  
 Ostalo  
 Pribor za mješanje

# Pribor za rušenje i udarno bušenje

## SDS-MAX ploče za rušenje

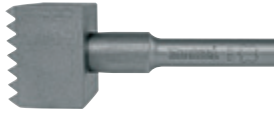

Model	Dimenzija	Opis
P-03947	60 x 60 mm	Ploča za rušenje
P-16352	220 mm	Osovina za ploču za rušenje

## SDS-MAX dleta za malter



Model	Širina	Ukupna dužina
P-16346	38 mm	280 mm

## SDS-MAX dleta za pločice

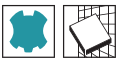

Model	Širina	Ukupna dužina
P-16324	50 mm	300 mm

## SDS-MAX lopata za glinu



Model	Širina	Ukupna dužina
P-23721	110 mm	400 mm

## SDS-MAX adapteri i produžeci

### Adapter SDS-MAX na SDS-Plus



Model	Prihvat	Ukupna dužina
P-17027	SDS-MAX/SDS-Plus	220 mm

## Dleta i šiljata dleta, šestougaoni prihvat, 17 mm

### Šiljata dleta



Model	Širina	Dužina	Specialnost
D-08682	/	280 mm	
P-13035	/	280 mm	
D-16863	/	450 mm	
P-13041	/	450 mm	

### Dleta



Model	Širina	Dužina	Specialnost
A-80569	17 mm	280 mm	
D-08707	17 mm	280 mm	
P-13057	25 mm	280 mm	
D-16879	19 mm	450 mm	
P-13063	17 mm	450 mm	

### Široka dleta



Model	Širina	Dužina	Specialnost
D-20694	50 mm	280 mm	
P-13079	45 mm	280 mm	

### Dleta za kanale



Model	Širina	Dužina	Specialnost
A-48561	26 mm	280 mm	

## Lopaticice



Model	Širina	Dužina	Specialnost
P-13085	110 mm	400 mm	

## Nabijači

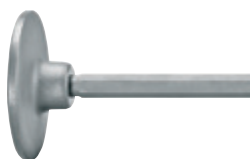

Model	Širina	Dužina	Specialnost
A-21428	140 mm	265 mm	

## Dleta i šiljata dleta, šestougaoni prihvati, 19 mm, B-tip

### Šiljata dleta



Model	Širina	Dužina	Specialnost
P-05620	/	400 mm	
P-05614	/	600 mm	

### Dleta



Model	Širina	Dužina	Specialnost
P-05636	25 mm	400 mm	
P-05642	25 mm	600 mm	

## Dleta i šiljata dleta, šestougaoni prihvati, 19 mm

### Šiljata dleta



Model	Širina	Dužina	Specialnost
P-13340	/	220 mm	

### Dleta



Model	Širina	Dužina	Specialnost
P-13356	30 mm	150 mm	

### Široka dleta



Model	Širina	Dužina	Specialnost
P-05474	50 mm	190 mm	
P-13362	50 mm	190 mm	

### Široka dleta



Model	Širina	Dužina	Specialnost
P-05664	60 mm	300 mm	

## Dleta i šiljata dleta, šestougaoni prihvati, 19 mm, K-tip

### Dleta za kanale



Model	Širina	Dužina	Specialnost
P-13188	22 mm	250 mm	

Akumulat  
ori i  
punjači

Pribor za  
akumulat  
orske  
alate

Akumulat  
orske  
lampe i  
pribor

Pribor za  
laserske  
merace

Pribor za  
rušenje i  
udarno  
bušenje

Pribor za  
bušenje

Krunaste  
testere

Pribor za  
pritrzanje  
e

Pribor za  
sečenje i  
brusenje

Pribor za  
brusenje  
i  
poliranje

Pribor za  
profilisanje  
e i  
poravnava

Pribor za  
višenam  
enski alat

Pribor za  
testere

Pribor za  
pneumat  
ske alate

Pribor za  
fenove  
za vrući  
vazduh

Pribor za  
usisivanje

Pribor za  
alate za  
rad na  
otvoreno

Pribor za  
držače  
alata i  
zaštitna

Koferi i  
torbe

Ručni  
alati

Ostalo

Pribor za  
mješanje

# Pribor za rušenje i udarno bušenje

## Dleta i šiljata dleta, šestougaoni priхват, 21 mm

### Šiljata dleta



Model	Širina	Dužina	Specialnost
P-13378	/	320 mm	
P-13384	/	450 mm	
P-13390	/	600 mm	

### Dleta



Model	Širina	Dužina	Specialnost
P-13409	26 mm	320 mm	
P-13415	26 mm	450 mm	
P-13421	26 mm	600 mm	

### Široka dleta



Model	Širina	Dužina	Specialnost
P-13437	70 mm	320 mm	

## Dleta i šiljata dleta, šestougaoni priхват, 28,6 mm, B-tip

### Šiljata dleta



Model	Širina	Dužina	Specialnost
D-65034	/	350 mm	
B-10372	/	400 mm	Samooštreće
P-05692	/	400 mm	
D-17631	/	410 mm	
D-61531	/	410 mm	
P-19180	/	500 mm	
D-17675	/	520 mm	
D-61569	/	520 mm	

### Dleta



Model	Širina	Dužina	Specialnost
P-05723	29 mm	400 mm	
D-17647	28 mm	410 mm	
D-17681	28 mm	520 mm	
D-61547	28 mm	410 mm	Bez ruba
D-61575	28 mm	520 mm	Bez ruba

### Široka dleta



Model	Širina	Dužina	Specialnost
P-05701	80 mm	400 mm	
D-61553	75 mm	410 mm	Bez ruba
D-61581	75 mm	520 mm	Bez ruba

### Lopatice



Model	Širina	Dužina	Specialnost
P-05717	125 mm	400 mm	

## Dleta i šiljata dleta, šestougaoni priхват, 30 mm

### Šiljata dleta



Model	Širina	Dužina	Specialnost
B-10388	/	400 mm	Samooštreće
P-05549	/	400 mm	
P-05561	/	700 mm	
P-05577	/	1.000 mm	

# Pribor za rušenje i udarno bušenje

## Dleta



Model	Širina	Dužina	Specialnost
P-13487	32 mm	400 mm	
P-13502	32 mm	400 mm	HM1400
P-05583	32 mm	700 mm	
P-05599	32 mm	1.000 mm	

## Široka dleta



Model	Širina	Dužina	Specialnost
P-13493	115 mm	400 mm	HM1400
P-13518	115 mm	400 mm	

## Lopatice



Model	Širina	Dužina	Specialnost
P-05555	125 mm	400 mm	
P-05608	125 mm	400 mm	HM1400

## Nabijači



Model	Širina	Dužina	Specialnost
A-86941	200 mm	255 mm	

## Probojne burgije i pribor

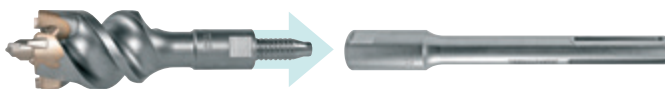

### Probojne burgije

Performanse burgija za beton: Brzo postavljanje. Bušenje rupa sa završnim prečnikom, bez prethodnog bušenja. Konstrukcija sa prenosom udarne energije kroz jedan deo do radnog komada, bez gubitka snage alata. Promenljiva dubina u zavisnosti od dužine vretena. Pravi, kružni otvori sa ravnim dnom. Značajno poboljšane performanse bušenja, u poređenju sa krunastim burgijama, posebno kod bušenja u armirani beton.



Model	Prečnik
P-04008	35 mm
P-03844	40 mm
P-03850	50 mm
P-04014	55 mm
P-04020	60 mm
P-03866	68 mm
P-03872	80 mm
P-04036	90 mm

### Adapter SDS-MAX za probojne burgije



Model	Opis
P-03903	160 mm, HEX 13
P-03888	185 mm, SDS-MAX

### Produžetak za probojne burgije



Model	Dužina
P-03925	280 mm

### Navojna šipka



Model	Dužina
P-03931	60 mm

Akumulat  
ori i  
punjači

Pribor za  
akumulat  
orske  
alate

Akumulat  
orske  
lampe i  
pribor

Pribor za  
laserske  
merace

Pribor za  
rušenje i  
udarno  
bušenje

Pribor za  
bušenje

Krunaste  
testere

Pribor za  
pritzanje

Pribor za  
sečenje i  
brusjenje

Pribor za  
brusjenje  
i  
poliranje

Pribor za  
profilisanje  
i  
poravnavanje

Pribor za  
višenam  
enski alat

Pribor za  
pneumat  
ske alate

Pribor za  
fenove  
vazduh

Pribor za  
usisivanje

Pribor za  
alate za  
rad na  
otvoreno

Pribor za  
držače  
alata i  
zaštitna

Koferi i  
torbe

Ručni  
alati

Ostalo

Pribor za  
mješanje

# Pribor za rušenje i udarno bušenje

## MAK-sistem povezivanja

Sistem povezivanja omogućava bezbednu i brzu konekciju između alata, produžetka i pribora za bušenje. Povezujući adapter garantuje konekciju bez gubitka energija u prenosu. Energija se prenosi na pribor direktno i omogućava rad sa maksimalnom snagom. MAK-sistem povezivanja je izvanredno izdržljiv, zato su šanse za preopterećenje vrlo male. Upotreba je moguća sa SDS-MAX burgijama dimenzije veće od 32mm.

## Adapter GKW na SDS-MAX



Model	Prihvati	Ukupna dužina
P-53958	GKW/SDS-MAX	320 mm

## Produžeci SDS-MAX na SDS-MAX



Model	Prihvati	Ukupna dužina
P-53920	SDS-MAX/SDS-MAX	320 mm
P-53936	SDS-MAX/SDS-MAX	750 mm
P-53942	SDS-MAX/SDS-MAX	1.100 mm

## Povezujući adapter



Model	Prihvati	Ukupna dužina
P-53914	SDS-MAX/SDS-MAX	190 mm

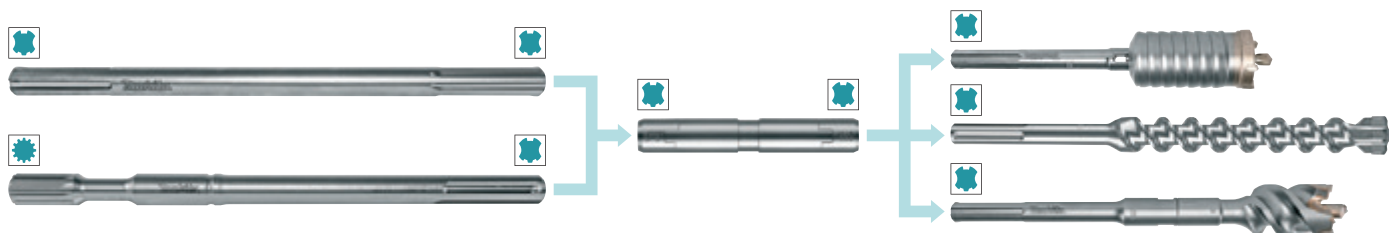

# Pribor za rušenje i udarno bušenje

## Krunaste burgije sa konusnim prihvatom i pribor



### Krunaste burgije sa konusnim prihvatom"

Krunaste burgije sa konusnim prihvatom za beton, malter i kamen. Odlična rotaciona stabilnost i prilagodljivost alata, sa zupcima za vođenje. Ravni udarni zupci rade sa visokom efikasnošću u pripremljenoj izbušenoj osnovi.



Model	Prečnik	Dubina bušenja
P-03779	40 mm	60 mm
P-03785	50 mm	60 mm
P-03791	65 mm	60 mm
P-03800	80 mm	60 mm
P-03816	90 mm	60 mm
P-03822	100 mm	60 mm
P-16374	125 mm	60 mm

### Adapter za krunaste burgije sa konusnim prihvatom



Model	Ukupna dužina	Prihvat
P-03729	185 mm	13 mm HEX
P-03735	450 mm	13 mm HEX
P-16994	180 mm	SDS-MAX
P-17005	450 mm	SDS-MAX

### Centralna burgija za krunastu burgiju sa konusnim prihvatom



Model	Ukupna dužina
P-03838	11x120 mm

### Zakošeni ključ za krunaste burgije



Model	Ukupna dužina
P-03763	140 mm

## Ostali pribor

### Sredstva za podmazivanje



Model	Naziv
195127-0	Mast za burgije i dleta, 30 g
198993-4	Mast za burgije i dleta, 100 g

### Kolica za transport

















Model	Naziv	Za model
D-54972	Kolica za transport	HM1800, HM1801, HM1802, HM1810, HM1812



- Akumulat ori i punjači
- Pribor za akumulat orske alate
- Akumulat orske lampe i pribor
- Pribor za lasarske merace
- Pribor za rušenje i udarno bušenje
- Pribor za bušenje
- Krunaste testere
- Pribor za pritezanje
- Pribor za sečenje i brušenje
- Pribor za brušenje i poliranje
- Pribor za profilisanje i poravnavanje
- Pribor za višenamenski alat
- Pribor za testere
- Pribor za pneumatske alate
- Pribor za fenove za vrući vazduh
- Pribor za usisivanje
- Pribor za alate za rad na otvoreno
- Pribor za držače alata i zaštitna
- Koferi i torbe
- Ručni alati
- Ostalo
- Pribor za mješanje

# Pribor za rušenje i udarno bušenje

## Kompleti za rušenje i udarno bušenje SDS-Plus

Razred kvaliteta	Model	Br. Komada	Dimenzije			Kovčec
			Dleta	Burgije	Šiljata dleta	
★★★★★	B-58992	5	/	5, 6x115 mm; 6, 8, 10x165 mm	/	
★★★★★	B-59075	3	/	6, 8, 10x165 mm	/	
★★★★	B-49046	7	/	5, 6, 8x110 mm; 6, 8, 10, 12x160 mm	/	
★★★★	P-29751	5	/	5, 6, 8x110 mm; 6, 8x160 mm	/	
★★★★	B-54704	5	/	6x110 mm; 8, 10x160 mm	/	
★★★★	B-57532	5	/	Drvo: 4x105 mm, 5x116 mm, 6x123 mm; HSS-TiN: 3x90 mm, 4x105 mm	/	
★★★★	E-14249	4	/	5 x 110 mm, 6, 8, 10 x 160 mm	/	
★★	D-00795	5	/	5, 6, 8x110 mm; 6, 8x160 mm	/	
★★	D-17784	5	/	6, 6.5x110 mm; 8, 10, 12x160 mm	/	
★★	D-20703	5	/	5, 6, 7, 8, 10x160 mm	/	
★★	D-36049	5	/	6, 6, 8, 10, 12x160 mm	/	
★★	D-58914	5	/	5, 6, 6, 8, 8x160 mm	/	
★★	D-61678	5	/	6, 8x110 mm; 6, 8, 10x160 mm	/	
★★	D-40602	25	/	5x (5, 6, 8x110 mm); 5x (6, 8x160 mm)	/	
★★★★	E-04911	3	20x250 mm; 40x250 mm	/	250 mm	
★★★★	E-13188	5	2 x (20x250 mm), 40x250 mm	/	2 x 250 mm	
★★	D-42357	3	20x250 mm; 40x250 mm	/	250 mm	
★★	D-71314	3	20x230 mm; 40x230 mm	/	230 mm	
★★	D-42363	4	2x (20x250 mm)	/	2x250 mm	
★★	D-42379	5	2x (20x250 mm); 40x250 mm	/	2x250 mm	
★★	D-58920	6	20x250 mm; 40x250 mm	5, 6, 8x160 mm	250 mm	
★★	D-21191	10	20x250 mm	5, 5, 6x110 mm; 7, 8x160 mm; 10x210 mm; 10, 16, 20x460 mm	250 mm	
★★	D-42385	10	20x250 mm	6x110 mm; 8x160 mm; 10, 12x210 mm; 10, 12, 16, 20x460 mm	250 mm	
★★	D-20111	13	20x250 mm	5, 6, 7, 8x110 mm; 6, 7, 8, 10, 12, 14x160 mm; 16x210 mm	250 mm	
★★	D-53659	13	20x250 mm	5, 6, 7, 8x110 mm; 6, 7, 8, 10, 12, 14, 16x160 mm	250 mm	
★★	D-71174	14	20x250 mm	5, 6, 7, 8x110 mm; 6, 7, 8, 10, 12, 14, 16x160 mm	250 mm	
★★	B-52059	17	20x140 mm; 20x250 mm; 40x250 mm	5, 5, 5, 6, 7x110 mm; 5, 5, 6, 7, 8, 10x160 mm; 8, 10x210 mm; 14x260 mm	140 mm; 250 mm	
★★	B-53877	17	20x140 mm; 20x250 mm; 40x250 mm	5, 6, 7, 8x110 mm; 5, 6, 7, 10x160 mm; 8, 10, 12x210 mm; 14x260 mm	140 mm; 250 mm	
★★	D-21200	17	20x140 mm; 20x250 mm; 40x250 mm	5, 5, 5, 6, 8, 10x110 mm; 6, 7, 8, 10x160 mm; 8, 10x210 mm; 14x260 mm	140 mm; 250 mm	
★★	D-42444	17	20x140 mm; 20x250 mm; 40x250 mm	5, 6, 8, 10x110 mm; 6, 8, 10, 12x160 mm; 8, 10x210 mm; 12, 14x260 mm	140 mm; 250 mm	
★★	D-71180	18	20x140 mm; 20x250 mm; 40x250 mm	5, 6, 8, 10x110 mm; 6, 8, 10, 12x160 mm; 8, 10x210 mm; 10, 12x260 mm	140 mm; 250 mm	
★★	D-71196	18	20x140 mm; 20x250 mm; 40x250 mm	5, 6, 8, 10x110 mm; 6, 8, 10, 12x160 mm; 8, 10x210 mm; 12, 14x260 mm	140 mm; 250 mm	

## Kompleti za rušenje i udarno bušenje SDS-MAX

Razred kvaliteta	Model	Br. Komada	Dimenzije			Kofer
			Dleta	Burgije	Šiljata dleta	
Specialized	P-52445	5	25x400 mm; 50x400 mm	25, 25x520 mm; 32x570 mm	400 mm	
★★★★	E-13194	5	2 x (25x400 mm), 50x350 mm	/	2 x 400 mm	
★★	D-42450	3	25x400 mm; 50x400 mm	/	400 mm	
★★	D-42466	4	25x300 mm; 25x400 mm	/	300 mm; 400 mm	
★★	P-18013	4	25x280 mm; 25x400 mm	/	280 mm; 400 mm	
★★	D-42488	6	2x (25x400 mm); 50x400 mm; 80x300 mm	/	2 x 400 mm	



# Pribor za rušenje i udarno bušenje

B-58992	B-59075	B-49046	P-29751	B-54704	B-57532	E-14249	Akumulat ori i punjači
							Pribor za akumulat orske alate
D-00795	D-17784	D-20703	D-36049	D-58914	D-61678	D-40602	Akumulat orske lampe i pribor
							Pribor za laserske merace
D-00795	D-17784	D-20703	D-36049	D-58914	D-61678	D-40602	Pribor za rušenje i udarno bušenje
							Pribor za rušenje i udarno bušenje
D-00795	D-17784	D-20703	D-36049	D-58914	D-61678	D-40602	Pribor za bušenje
							Krunaste testere
D-00795	D-17784	D-20703	D-36049	D-58914	D-61678	D-40602	Pribor za pritzanji e
							Pribor za sečenje i brusjenje
D-00795	D-17784	D-20703	D-36049	D-58914	D-61678	D-40602	Pribor za brusjenje i poliranje
							Pribor za profilisanje i poravnavanje
D-00795	D-17784	D-20703	D-36049	D-58914	D-61678	D-40602	Pribor za višenamenski alat
							Pribor za testere
D-00795	D-17784	D-20703	D-36049	D-58914	D-61678	D-40602	Pribor za pneumatske alate
							Pribor za fenove za vrući vazduh
B-52059	B-53877	D-21200	D-42444	D-71180	D-71196		Pribor za usisivanje
							Pribor za alate za rad na otvoreno
B-52059	B-53877	D-21200	D-42444	D-71180	D-71196		Pribor za držače alata i zaštitna
							Koferi i torbe
P-52445	E-13194	D-42450	D-42466	P-18013	D-42488		Ručni alati
							Ostalo
P-52445	E-13194	D-42450	D-42466	P-18013	D-42488		Pribor za mješanje

# Pribor za rušenje i udarno bušenje















## Sakupljač prašine za udarne alate sa SDS-Plus/SDS-MAX prihvatom

### Sakupljač prašine za rušenje i udarno bušenje

	Model	Naziv	Za model	Cena sa PDV-om
	122709-5	Sakupljač prašine	HR2432	
	191E54-9	Komplet za usisavanje prašine DX12	HR001G, HR003G	
	191E60-4	Komplet za usisavanje prašine DX14	HR002G,HR004G	
	191F49-8	Spremište za prašinu DX10,11	DX10, DX11	
	191F95-1	Komplet za usisavanje prašine DX10	HR3011FC	
	191G00-4	Komplet za usisavanje prašine DX11	HR3012FC	
	191L91-5	Adapter za sakupljač prašine 195173-3	HR3011FC, HR3001C	
	191M20-4	Nastavak za usisavanje prašine	HM1501, HM1502, HM1512	
	191M21-2	Nastavak za usisavanje prašine	HM1501, HM1502, HM1512	
	192176-8	Komplet za usisavanje prašine	DHR200, HR160D, HR1800, HR2010	
	193472-7	Komplet za usisavanje prašine	DHR202, DHR241, HR2020, HR2440, HR2440F, HR2440X, HR2450, HR2450F, HR2450T, HR2470, HR2810, HR2811	
	194581-5	Adapter za sakupljač prašine SDS-Plus 198362-9	DHR165, DHR171, DHR182, HR140D, HR166D, HR1830, HR1840, HR1841F	

[Nastavak...](#)

# Pribor za rušenje i udarno bušenje

Model	Naziv	Za model	Cena sa PDV-om	
195173-3	Kapa za sakupljanje prašine	HR2300, HR2600, HR2610, HR2611F, HR3011FC, HR3001C, HR007G		
195179-1	Kapa za skupljanje prašine set	DHR243, HR2300, HR2310T, HR2600, HR2320T, HR2630T/F, HR2361FT, HR2641, HR2653T, HR2652, HR2653, HR3012FC		
195866-2	Nastavak za usisavanje prašine	HR4001C, HR4002, HR4010C, HR4011C, HR4501C, HR4510C, HR4511C		
196535-8	Nastavak za usisavanje prašine	HR4013C, HR4003C, HR4002		
196861-5	Nastavak za usisavanje prašine	HR5202C, HR5212C, HR5201C, HR5211C		
197148-8	Nastavak za usisavanje prašine	HM1304/B, HM1317C/CB, HM1801, HM1802, HM1810, HM1812		
197168-2	Nastavak za usisavanje prašine	HM1304/B, HM1317C/CB, HM1801, HM1802, HM1810, HM1812		
198362-9	Nastavak za usisavanje prašine SDS-Plus	DHR165, DHR171, DHR182, HR140D, HR166D, HR1830, HR1840, HR1841F		
198981-1	Spremište za prašinu HR2650, HR2651	HR2650, HR2651		
199142-6	Sakupljač prašine	DHR400, HR005G, HR4003C, HR4013C		
199143-4	Sakupljač prašine	DHR400, HM001G, HM002G, HR005G, HR006G, HM0870C, HM0871C, HM1101C, HM1111C, HM1203C, HM1213C, HM1214C, HR3530, HR3540C, HR3541FC, HR4002, HR4003C, HR4013C, HR4501C, HR4511C, HR5212C, HR5202C		
199144-2	Sakupljač prašine	DHR400, HM001G, HM002G, HR005G, HR006G, HM0870C, HM0871C, HM1101C, HM1111C, HM1203C, HM1213C, HM1214C, HR3530, HR3540C, HR3541FC, HR4002, HR4003C, HR4013C, HR4501C, HR4511C, HR5212C, HR5202C		
199555-1	Set kutije za prašinu	DX06, DX07, DX08, DX09, DX12, DX14		
199557-7	Filter set DX02,3,4,6,7,8,9,12,14,15	DX01, DX02, DX06, DX07, DX08, DX09, DX12, DX14, DX15, HR2650, HR2651, HR2651T, HR2661 HR2652, HR2653, HR2653T, HR2663, HR007G		

Nastavak...



- Akumulat orni i punjači
- Pribor za akumulat orske alate
- Akumulat orske lampe i pribor
- Pribor za laserske merace
- Pribor za rušenje i udarno bušenje
- Pribor za bušenje
- Krunaste testere
- Pribor za pritezanje
- Pribor za sečenje i bušenje
- Pribor za bušenje i poliranje
- Pribor za profilisanje i poravnane
- Pribor za višenamenski alat
- Pribor za testere
- Pribor za pneumatske alate
- Pribor za fenove za vrući vazduh
- Pribor za usisavanje
- Pribor za alate za rad na otvoreno
- Pribor za držače alata i zaštitna
- Koferi i torbe
- Ručni alati
- Ostalo
- Pribor za mješanje

# Pribor za rušenje i udarno bušenje

	Model	Naziv	Za model	Cena sa PDV-om
	199572-1	Komplet za usisavanje prašne DX07	DHR243	
	199581-0	Komplet za usisavanje prašne DX08	DHR280	
	199585-2	Komplet za usisavanje prašne DX09	DHR283	
	199586-0	Spremište za prašinu DX15	HR007G	
	199595-9	Spremište za prašinu DX05	DX05	
	199596-7	Filter DX05	DX05	
	199660-4	Komplet za usisavanje prašine DX05	HR182D	
	199977-5	Spremište za prašinu DX01	DX01	
	331886-4	Graničnik dubine	HR2600, HR2610, HR2611	
	421342-3	Poklopac za zaštitu od prašine	Ø 6 - 14,5 mm	
	421384-7	Zaptivna kapa	DHR261, HR2020, HR2432, HR2440, HR2440F, HR2440X, HR2450, HR2450F, HR2450T, HR2470, HR2810, HR2811	
	421664-1	Poklopac za zaštitu od prašine	Ø 12 - 16 mm	
	421755-8	Vodootporni poklopac	HR1830	
	423154-0	Poklopac za zaštitu od prašine	HK1800, HK1810	

[Nastavak...](#)

# Pribor za rušenje i udarno bušenje

Model	Naziv	Za model	Cena sa PDV-om	
P-05446	Poklopac za zaštitu od prašine	HM1303, HM1400		
P-80488	Sakupljač prašine	>Ø 24 mm		

Akumulatori i punjači

Pribor za akumulatorske alate

Akumulatorske lampe i pribor

Pribor za laserske merace

Pribor za rušenje i udarno bušenje

Pribor za bušenje

Krunaste testere

Pribor za pritezanje

Pribor za sečenje i brusenje

Pribor za brusenje i poliranje

Pribor za profilisanje i poravnavanje

Pribor za višenamenski alat

Pribor za testere

Pribor za pneumatske alate

Pribor za fenove za vrući vazduh

Pribor za usisivanje

Pribor za alate za rad na otvoreno

Pribor za držače alata i zaštitna

Koferi i torbe

















Ručni alati

Ostalo

Pribor za mješanje













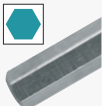

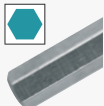

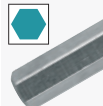

# PRIBOR ZA BUŠENJE

Beton		Modularna cigla	
Malter		Mekani pločasti kamen	
Cigla		Mermer	
Krečnjak		Granit	
		Staklo	
		Drvo	
		Šperploča	
		Keramičke pločice	
		MDF	
		Gips ploče	
		Iverica	
		Plastika, PVC	
		Staklena vlakna	
		Metali	
		Aluminijum	
		Nerdajući čelik	
		Obojeni metali	
		Cilindrični prihvati	
		Šestougaoni prihvati	
		Trostrani cilindrični prihvati	
		1/4" šestougaoni prihvati	
		Za kvadratni prihvati 3/4"	
		HSS burgije	
		HM CT burgije	
		HSS-Co 5% burgije	
		HSS-Co 8% burgije	
		HSS-TiN burgije	
		Za mokru upotrebu	
		Bušenje bez čekića	
		Duboko urezivanje	



# SERIJE BURGIJA ZA DRVO

BURGIJA		PLJOSNATE BURGIIJE	BURGIJE ZA DRVO		JEDNOREZNE SPIRALNE BURGIIJE		
OPIS		Pogodna za bušenje rupa srednjeg i velikog prečnika u mekom drvetu ili mekoj plastici.	Najpopularnija burgija za drvo podesna za bušenje rupa manjeg i srednjeg prečnika. Mogućnost bušenja meke plastike i mekog drveta. Veoma efikasna za bušenje čistih i preciznih rupa.		Pogodna za bušenje dubokih rupa srednjeg i velikog prečnika u mekom ili tvrdom drvetu. Vrh burgije sa navojem olakšava prodor burgije u materijal i na taj način omogućava samourezivanje. Preciznije i čistije bušenje rupa u odnosu na ravnu burgiju i burgiju za drvo.		
Tehnički podatci	SERIJA	Pljosnate burgije	Burgije za drvo	Burgije za drvo (dugo prihvat)	Jednoredne spiralne burgije (cilindrični prihvat)	Jednoredne spiralne burgije (dugo prihvat)	3D jednoredne spiralne burgije (dugo)
	PREČNIK (Ø)	6 - 36 mm	3 - 20 mm	2 - 15 mm	6 - 30 mm	6 - 21 mm	6 - 30 mm
	DUŽINA	150 - 160 mm	60 - 335 mm	69 - 160 mm	200 - 450 mm	200 mm	400 - 500 mm
	VRH	Sa šiljkom 	Sa šiljkom 	Sa navojem 			
	PRIHVAT	Šestougaoni 	Cilindrični 	Šestougaoni 1/4" MZ 	Šestougaoni 	Šestougaoni 1/4" MZ 	Šestougaoni 
MATERIJALI	DRVO 	★★	★★		★★		
	DRVO SA EKSERIMA 						
	IVERICA 		★		★		
OBRADA	DEBLJINA 						
	SLEPA RUPA 		★				
NAČINI PRIMENE							





BURGIJE ZA OPLATU	SAMOUREZNE BURGIJE ZA DRVO	BURGIJE ZA ŠARKE	PODESIVI KRUŽNI REZAČI
Zahvaljujući svojoj ukupnoj dužini (400 i 600 mm) može se koristiti za bušenje jedne ili više komada šperploča postavljenih jedna na drugu.	Pogodno za bušenje rupa velikog prečnika u drvetu. Navoj na vrhu omogućava brzo i lako uranjanje burgije i uklanjanje materijala. Pogodno za vodovodne instalacije, električne instalacije ...	Pogodna za bušenje slepih rupa ili bušenje rupa srednjeg i velikog prečnika. Podesna je za precizne radove kao što je izrada nameštaja.	Može se koristiti na raznim različitim materijalima. Maksimalna dubina bušenja: gips 20 mm, iverica 12 mm, MDF 12 mm, plastika 4 mm, drvo 20 mm. Iverica i MDF moraju biti tanji od 12 mm, plastične ploče moraju biti tanje 4 mm.
Burgije za oplatu	Samourezne burgije za drvo (dugo prihvat)	Burgije za šarke	Podesivi kružni rezači
8 - 30 mm	25 - 76 mm	10 - 50 mm	30 - 200 mm
400 - 600 mm	127 mm	90 mm	-
Dleto ivica	Sa navojem	Sa šiljkom (kratak)	Dleto ivica
Cilindrični	Šestougaoni 7/16"	Cilindrični	Trostrani cilindrični
★	★★	★★	★
★			
★★			★
		★★	

Tanki materijali   
 Deblji materijali   
 ★ Prihvatljiva   
 ★★ Preporučena

## Burgije za drvo

### Plosnate burgije za drvo

Jaki kvalitetni pljosnati umeci, pogodni za tvrdo i mekano drvo. Prečnici: 6 - 36 mm; za poslove sa visokim obrtnim momentom.



Model	Prečnik	Ukupna dužina	Prihvat
D-07674	6 mm	150 mm	CYL
D-07680	8 mm	150 mm	HEX
D-07696	10 mm	150 mm	HEX
D-07705	12 mm	150 mm	HEX
D-07711	14 mm	150 mm	HEX
D-07727	15 mm	150 mm	HEX
D-07733	16 mm	150 mm	HEX
D-07749	18 mm	150 mm	HEX
D-07755	20 mm	150 mm	HEX
D-07761	22 mm	150 mm	HEX
D-07777	24 mm	150 mm	HEX
D-07783	25 mm	150 mm	HEX
D-07799	26 mm	160 mm	HEX
D-07808	28 mm	160 mm	HEX
D-07814	30 mm	160 mm	HEX
D-07820	32 mm	160 mm	HEX
D-07836	34 mm	160 mm	HEX
D-07842	35 mm	160 mm	HEX
D-07858	36 mm	160 mm	HEX

### Burgija za drvo sa 3 vrha, cilindrični prihvat

Ove burgije su odlične za primenu u tvrdo ili mekano drvo. Imaju izbrušeno čelično telo sa tačkom za centriranje.



Model	Prečnik	Ukupna dužina	Radna dužina
D-07026	3 mm	60 mm	33 mm
D-07032	4 mm	75 mm	43 mm
D-07048	5 mm	85 mm	52 mm
D-07054	6 mm	95 mm	57 mm
D-07157	6 mm	315 mm	150 mm
D-07060	7 mm	110 mm	69 mm
D-07076	8 mm	115 mm	75 mm
D-07163	8 mm	315 mm	150 mm
D-07082	9 mm	135 mm	80 mm
D-07098	10 mm	135 mm	87 mm
D-07179	10 mm	315 mm	150 mm
D-07107	12 mm	155 mm	96 mm
D-07185	12 mm	315 mm	150 mm
D-07113	14 mm	170 mm	100 mm
D-07191	14 mm	315 mm	150 mm
D-07129	16 mm	180 mm	100 mm
D-07200	16 mm	315 mm	150 mm
D-07135	18 mm	200 mm	120 mm
D-07216	18 mm	335 mm	150 mm
D-07141	20 mm	200 mm	130 mm
D-07222	20 mm	335 mm	150 mm

### Burgija za drvo sa 3 vrha sa 1/4" prihvatom



Model	Prečnik	Ukupna dužina	Radna dužina
D-62387	2 mm	69 mm	24 mm
D-15861	3 mm	78 mm	33 mm
D-15877	4 mm	92 mm	50 mm
D-15883	5 mm	103 mm	57 mm
D-15899	6 mm	110 mm	65 mm
D-15908	8 mm	117 mm	75 mm
D-15914	10 mm	133 mm	87 mm
D-15920	12 mm	151 mm	96 mm
D-15936	15 mm	162 mm	100 mm

### Spiralne burgije za 13 mm futere za bušenje

Spiralne burgije pogodne za duboko, čisto i brzo bušenje, zahvaljujući specifičnoj geometriji. Najpovoljnije su za bušenje u tvrdo, mekano, laminirano, puno drvo i grede.



Model	Prečnik	Ukupna dužina	Radna dužina
D-07238	6 mm	200 mm	130 mm
D-07331	6 mm	250 mm	180 mm
D-07244	8 mm	200 mm	130 mm
D-07347	8 mm	250 mm	180 mm
D-07434	8 mm	400 mm	330 mm
D-07559	8 mm	450 mm	380 mm
D-07250	10 mm	200 mm	130 mm
D-07353	10 mm	250 mm	180 mm
D-07440	10 mm	400 mm	330 mm
D-07565	10 mm	450 mm	380 mm
D-07266	12 mm	200 mm	130 mm
D-07369	12 mm	250 mm	180 mm
D-07456	12 mm	400 mm	330 mm
D-07571	12 mm	450 mm	380 mm
D-07272	14 mm	200 mm	130 mm
D-07375	14 mm	250 mm	180 mm
D-07462	14 mm	400 mm	330 mm
D-07587	14 mm	450 mm	380 mm
D-07288	16 mm	200 mm	130 mm
D-07381	16 mm	250 mm	180 mm
D-07478	16 mm	400 mm	330 mm
D-07593	16 mm	450 mm	380 mm
D-07294	18 mm	200 mm	130 mm
D-07397	18 mm	250 mm	180 mm
D-07484	18 mm	400 mm	330 mm
D-07602	18 mm	450 mm	380 mm
D-07303	20 mm	200 mm	130 mm
D-07406	20 mm	250 mm	180 mm
D-07490	20 mm	400 mm	330 mm
D-07618	20 mm	450 mm	380 mm
D-07319	22 mm	200 mm	130 mm
D-07412	22 mm	250 mm	180 mm
D-07509	22 mm	400 mm	330 mm
D-07624	22 mm	450 mm	380 mm
D-07325	24 mm	200 mm	130 mm
D-07428	24 mm	250 mm	180 mm

# Pribor za bušenje

D-07515	24 mm	400 mm	330 mm
D-07630	24 mm	450 mm	380 mm
D-07521	26 mm	400 mm	330 mm
D-07646	26 mm	450 mm	380 mm
D-07537	28 mm	400 mm	330 mm
D-07652	28 mm	450 mm	380 mm
D-07543	30 mm	400 mm	330 mm
D-07668	30 mm	450 mm	380 mm

## Spiralne burgije za 13 mm futere za bušenje - dugačke

Spiralne burgije pogodne za duboko, čisto i brzo bušenje, zahvaljujući specifičnoj geometriji. Najpovoljnije su za bušenje u tvrdo, mekano, laminirano, puno drvo i grede.



Model	Prečnik	Ukupna dužina	Radna dužina
P-58497	8 mm	600 mm	520 mm
P-58506	10 mm	600 mm	520 mm
P-58512	12 mm	600 mm	520 mm
P-58528	14 mm	600 mm	520 mm
P-58534	16 mm	600 mm	520 mm
P-58540	18 mm	600 mm	520 mm
P-58556	20 mm	600 mm	520 mm
P-58562	22 mm	600 mm	520 mm
P-58578	24 mm	600 mm	520 mm
P-58584	26 mm	600 mm	520 mm
P-58590	28 mm	600 mm	520 mm
P-58609	30 mm	600 mm	520 mm
P-58615	32 mm	600 mm	520 mm
P-58637	36 mm	600 mm	520 mm

## Spiralne burgije 1/4" prihvata

Spiralne burgije pogodne za duboko, čisto i brzo bušenje, zahvaljujući specifičnoj geometriji. Najpovoljnije su za bušenje u tvrdo, mekano, laminirano, puno drvo i grede.



Model	Prečnik	Ukupna dužina	Radna dužina
D-15992	6 mm	200 mm	130 mm
D-16003	8 mm	200 mm	130 mm
D-16019	10 mm	200 mm	130 mm
D-16025	12 mm	200 mm	130 mm
D-16031	14 mm	200 mm	130 mm
D-16047	16 mm	200 mm	130 mm
D-16053	18 mm	200 mm	130 mm
D-16069	20 mm	200 mm	130 mm
D-16075	21 mm	200 mm	130 mm

## Duge burgije za drvo 3D, šestougaoni prihvata



Model	Prečnik	Ukupna dužina	Radna dužina
E-07755	6 mm	400 mm	325 mm
E-07761	8 mm	400 mm	325 mm
E-07777	9 mm	400 mm	325 mm
E-07783	10 mm	400 mm	325 mm
E-07799	10,5 mm	400 mm	325 mm
E-07808	11 mm	400 mm	325 mm
E-07814	12 mm	400 mm	325 mm
E-07820	13 mm	400 mm	325 mm
E-07836	13,5 mm	400 mm	325 mm
E-07842	15 mm	400 mm	325 mm
E-07858	16 mm	400 mm	325 mm
E-07864	18 mm	400 mm	325 mm
E-07870	21 mm	400 mm	325 mm
E-07886	22 mm	400 mm	325 mm
E-07892	24 mm	400 mm	325 mm
E-07901	27 mm	400 mm	325 mm
E-07917	30 mm	400 mm	325 mm
E-07923	10,5 mm	500 mm	425 mm
E-07939	12 mm	500 mm	425 mm
E-07945	13 mm	500 mm	425 mm
E-07951	15 mm	500 mm	425 mm
E-07967	18 mm	500 mm	425 mm
E-07973	21 mm	500 mm	425 mm
E-07989	24 mm	500 mm	425 mm
E-07995	27 mm	500 mm	425 mm
E-08006	30 mm	500 mm	425 mm

## Burgija za bušenje oplata, cilindrični prihvata

Pogodne za drvo i šperploču. Veoma velika ukupna dužina omogućava bušenje rupa u daskama za šalovanje ili letvama 2x4 u jednom prolazu.



Model	Prečnik	Ukupna dužina	Radna dužina
D-70219	8 mm	400 mm	75 mm
D-70334	8 mm	600 mm	75 mm
D-70225	10 mm	400 mm	87 mm
D-70340	10 mm	600 mm	87 mm
D-70231	12 mm	400 mm	101 mm
D-70356	12 mm	600 mm	101 mm
D-70247	14 mm	400 mm	108 mm
D-70362	14 mm	600 mm	108 mm
D-70253	16 mm	400 mm	100 mm
D-70378	16 mm	600 mm	100 mm
D-70269	18 mm	400 mm	100 mm
D-70384	18 mm	600 mm	100 mm
D-70275	20 mm	400 mm	100 mm
D-70390	20 mm	600 mm	100 mm
D-70281	22 mm	400 mm	100 mm
D-70409	22 mm	600 mm	100 mm
D-70297	24 mm	400 mm	100 mm
D-70415	24 mm	600 mm	100 mm

# Pribor za bušenje

## Burgija za drvo, za klap šarke, cilindrični prihvat

Oblik zuba za brzo i precizno sečenje. Burgija je pogodna za bušenje u drvo, gde se zahteva visok kvalitet obrade; glatke ivice i bez cepanja radnog komada. Ciljne grupe su kućni dekorateri, stolari,...



Model	Prečnik	Ukupna dužina	Radna dužina
D-41844	10 mm	90 mm	60 mm
D-41925	15 mm	90 mm	60 mm
D-42232	20 mm	90 mm	60 mm
D-42248	25 mm	90 mm	60 mm
D-42254	26 mm	90 mm	60 mm
D-42260	30 mm	90 mm	60 mm
D-42276	32 mm	90 mm	60 mm
D-42282	35 mm	90 mm	60 mm
D-42298	40 mm	90 mm	60 mm
D-42307	50 mm	90 mm	60 mm

## Burgija za drvo, šestougaoni prihvat

Navoj na centrirnoj burgiji uvlači krunu u drvo za brzo i agresivno bušenje rupa za vodovodne cevi, električne instalacije i još mnogo toga kao i vadjenje čepova. Zubi na kruni brzo i precizno seku tačan prečnik rupe, a oksidna kruna pruža glatko bušenje i lako uklanjanje materijala. Korišćenjem namenskih nastavaka korisnik može da dosegne maksimalnu dubinu bušenja. Važno je da se uvek primenjuje odgovarajuća brzina bušenja.



Model	Prečnik	Ukupna dužina	Radna dužina
D-29935	25 mm	127 mm	80 mm
D-29957	28 mm	127 mm	80 mm
D-29963	32 mm	127 mm	80 mm
D-29979	35 mm	127 mm	80 mm
D-29985	38 mm	127 mm	80 mm
D-29991	45 mm	127 mm	80 mm
D-30003	51 mm	127 mm	80 mm
D-30019	54 mm	127 mm	80 mm
D-30025	57 mm	127 mm	80 mm
D-30031	65 mm	127 mm	80 mm
D-30047	76 mm	127 mm	80 mm
D-56518	92 mm	127 mm	80 mm
D-56524	117 mm	127 mm	80 mm

## Navojni pinovi za samoureznu burgiju za drvo



Model	Ukupna dužina	Pogodno za
D-30156	50 mm	Samourezne burgije (25-65 mm)
D-30162	70 mm	Samourezne burgije (76-117 mm)

## Produžeci za samourezne burgije



Model	Ukupna dužina	Pogodno za
D-35645	140 mm	samourezne burgije
D-35651	305 mm	samourezne burgije
D-35639	457 mm	samourezne burgije

## Kompleti



Model	Opis	Burgije u kompletu
D-36005	Produžna šipka (140 mm), Mali vrh sa navojem (3 kom.), Veliki vrh sa navojem, Imbus ključ (2 kom.), Zamenski navoji (2 kom.)	25, 32, 38, 51, 65, 76 mm

## Podesiv dodatak za izrezivanje kružnih otvora

Rezanje različitih materijala. Maks. dubina bušenja: Gips 20 mm, Šperploča 12 mm, MDF 12 mm, Plastika 4 mm, Drvo 20 mm. Šperploča i MDF treba da budu tanji od 12 mm, a plastična ploča tanja od 4 mm.

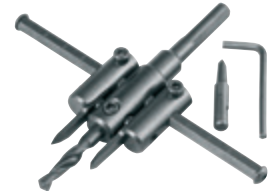
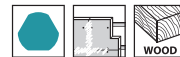

Model	Naziv	Prihvat	Prečnik rupe
D-57093	Podesivi kružni rezač	Trostrani cilindrični 10 mm	30-120 mm
D-57102	Podesivi kružni rezač	Trostrani cilindrični 10 mm	30-200 mm
D-57118	Rezervni noževi	/	/ mm

# POREĐENJE BUŠILICA ZA METAL

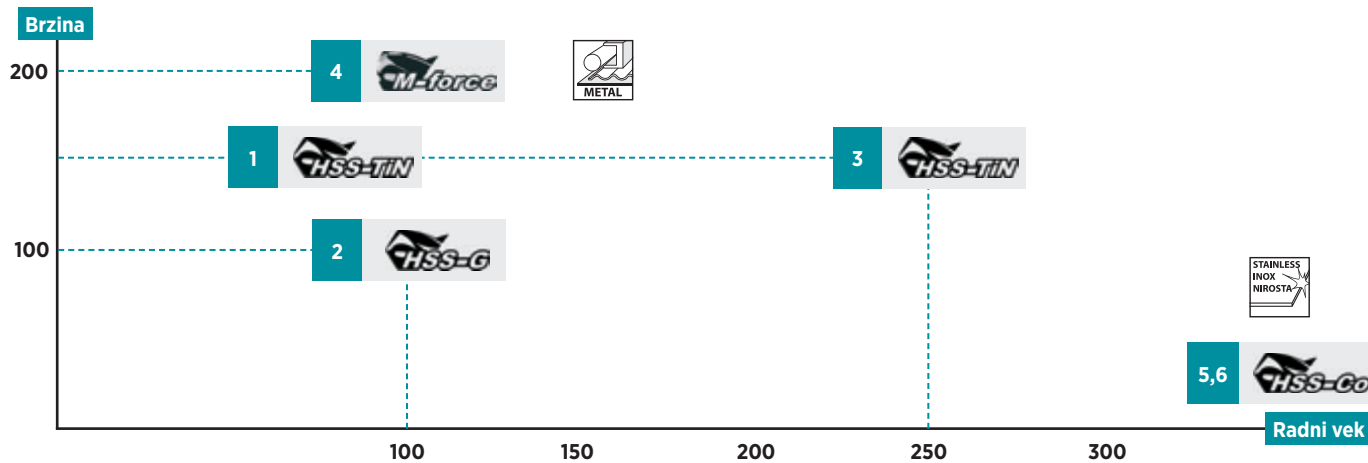

Broj	1	2	3	4	5	6
Klasa kvaliteta	★★	★★★	★★★★	★★★★	Specialized	Specialized
Seriya						
Opis	HSS-TiN	HSS-G	HSS-TiN Udarna bušilica	M-force	HSS-Co5%	HSS-Co8%
Vrh burgije*	Podeljen vrh 135°	Ivica dlata 118°	Podeljen vrh 135°	M-force oblik	Podeljen vrh 135°	Podeljen vrh 130°
Površina	Titanijumski premaz Duži životni vek		Titanijumski premaz Duži životni vek		Otporan na koroziju	
Prihvat	Cilindrični	Cilindrični	Šestougaoni 1/4"	Trostrani cilindrični Bolje prijanjanje od cilindričnog cilindrično zahvata	Cilindrični	Cilindrični

AA: Preporučena A: Prihvatljiva

Broj	1	2	3	4	5	6
Materijali	Drvo	A	A	A	A	
	Plastika	AA	AA	AA	AA	
	Obojeni metali**	AA	AA	AA	AA	A
	Čelični lim	AA	AA	AA	AA	A
	Liveno gvožđe	AA	AA	AA	AA	AA
	Legura čelika	AA	AA	AA	AA	AA
	Nerdajući čelik	A	A	A	A	AA

\* 135° Podeljen vrh. Obezbeđuje rad bez hodanja i brz početak bušenja.  
M-Oblik. Dizajniran za glatko i brzo bušenje.

\*\*Obojeni metali (kao što su bakar, nikl i cink)

## Burgije za metal

### HSS-G burgije za metal, cilindrični prihvat

Burgije za metal pogodne za crne i obojene metale, koje nude dobre brzine bušenja i duži radni vek. Dostupne su od 1,5 mm do 13 mm pojedinačno ili u pakovanju od više njih.



Model	Prečnik	Ukupna dužina	Radna dužina	Kom/kompl
D-09656	1,5 mm	40 mm	18 mm	1
D-06236	1,5 mm	40 mm	18 mm	10 / 1
D-06242	1,75 mm	46 mm	22 mm	10 / 1
D-09662	2 mm	49 mm	24 mm	1
D-06258	2 mm	49 mm	24 mm	10 / 1
D-06264	2,25 mm	53 mm	27 mm	10 / 1
D-09678	2,5 mm	57 mm	30 mm	1
D-06270	2,5 mm	57 mm	30 mm	10 / 1
D-06286	2,75 mm	61 mm	33 mm	10 / 1
D-09684	3 mm	61 mm	33 mm	1
D-06292	3 mm	61 mm	33 mm	10 / 1
D-06301	3,25 mm	65 mm	36 mm	10 / 1
D-09690	3,5 mm	70 mm	39 mm	1
D-06317	3,5 mm	70 mm	39 mm	10 / 1
D-06323	3,75 mm	70 mm	39 mm	10 / 1
D-09709	4 mm	75 mm	43 mm	1
D-06339	4 mm	75 mm	43 mm	10 / 1
D-06345	4,25 mm	75 mm	43 mm	10 / 1
D-09715	4,5 mm	80 mm	47 mm	1
D-06351	4,5 mm	80 mm	47 mm	10 / 1
D-06367	4,75 mm	80 mm	47 mm	10 / 1
D-09721	5 mm	86 mm	52 mm	1
D-06373	5 mm	86 mm	52 mm	10 / 1
D-06389	5,25 mm	86 mm	52 mm	10 / 1
D-09737	5,5 mm	93 mm	57 mm	1
D-06395	5,5 mm	93 mm	57 mm	10 / 1
D-06404	5,75 mm	93 mm	57 mm	10 / 1
D-09743	6 mm	93 mm	57 mm	1
D-06410	6 mm	93 mm	57 mm	10 / 1
D-06426	6,25 mm	101 mm	63 mm	10 / 1
D-09759	6,5 mm	101 mm	63 mm	1
D-06432	6,5 mm	101 mm	63 mm	10 / 1
D-06448	6,75 mm	109 mm	69 mm	10 / 1
D-09765	7 mm	109 mm	69 mm	1
D-06454	7 mm	109 mm	69 mm	10 / 1
D-06460	7,25 mm	109 mm	69 mm	10 / 1
D-09771	7,5 mm	109 mm	69 mm	1
D-06476	7,5 mm	109 mm	69 mm	10 / 1
D-06482	7,75 mm	117 mm	75 mm	10 / 1
D-09787	8 mm	117 mm	75 mm	1
D-06498	8 mm	117 mm	75 mm	10 / 1
D-06507	8,25 mm	117 mm	75 mm	5 / 1
D-09793	8,5 mm	117 mm	75 mm	1
D-06513	8,5 mm	117 mm	75 mm	5 / 1
D-06529	8,75 mm	125 mm	81 mm	5 / 1
D-09802	9 mm	125 mm	81 mm	1
D-06535	9 mm	125 mm	81 mm	5 / 1
D-06541	9,25 mm	125 mm	81 mm	5 / 1
D-09818	9,5 mm	125 mm	81 mm	1
D-06557	9,5 mm	125 mm	81 mm	5 / 1

D-06563	9,75 mm	133 mm	87 mm	5 / 1
D-09824	10 mm	133 mm	87 mm	1
D-06579	10 mm	133 mm	87 mm	5 / 1
D-06585	10,25 mm	133 mm	87 mm	5 / 1
D-09830	10,5 mm	133 mm	87 mm	1
D-06591	10,5 mm	133 mm	87 mm	5 / 1
D-09846	11 mm	142 mm	94 mm	1
D-06600	11 mm	142 mm	94 mm	5 / 1
D-09852	11,5 mm	142 mm	94 mm	1
D-06616	11,5 mm	142 mm	94 mm	5 / 1
D-09868	12 mm	151 mm	101 mm	1
D-06622	12 mm	151 mm	101 mm	5 / 1
D-09874	12,5 mm	151 mm	101 mm	1
D-06638	12,5 mm	151 mm	101 mm	5 / 1
D-09880	13 mm	151 mm	101 mm	1
D-06644	13 mm	151 mm	101 mm	5 / 1

### Burgije HSS-G (visokog kvaliteta) za metal, trostrani prihvat

Visoki kvalitet HSS-G burgija za profesionalce. Ugao na vrhu 130° i saglasnosti sa DIN 1412C. Pogodne su za čelike, legirane odlivke i nelegirane čelike sa zateznom čvrstoćom do <math>950\text{ N/mm}^2</math>, ne-fertne metale, nerđajuće čelike i aluminijum.



Model	Prečnik	Ukupna dužina	Radna dužina	Kom/kompl
P-60545-10	1 mm	34 mm	13 mm	10 / 1
P-60567-10	1,5 mm	40 mm	19 mm	10 / 1
P-60589-10	2 mm	49 mm	24 mm	10 / 1
P-60604-10	2,5 mm	57 mm	32 mm	10 / 1
P-60626-10	3 mm	61 mm	34 mm	10 / 1
P-60648-10	3,5 mm	70 mm	39 mm	10 / 1
P-60660-10	4 mm	75 mm	44 mm	10 / 1
P-60682-10	4,5 mm	80 mm	47 mm	10 / 1
P-60707-10	5 mm	86 mm	51 mm	10 / 1
P-60729-10	5,5 mm	93 mm	58 mm	10 / 1
P-60741-10	6 mm	93 mm	58 mm	10 / 1
P-60763-10	6,5 mm	101 mm	63 mm	10 / 1
P-60785-10	7 mm	109 mm	69 mm	10 / 1
P-60800-10	7,5 mm	109 mm	69 mm	10 / 1
P-60822-10	8 mm	117 mm	75 mm	10 / 1
P-60844-10	8,5 mm	117 mm	75 mm	10 / 1
P-60850-10	9 mm	125 mm	80 mm	10 / 1
P-60866-10	9,5 mm	125 mm	80 mm	10 / 1
P-60872-10	10 mm	133 mm	85 mm	10 / 1
P-60888-5	10,5 mm	133 mm	85 mm	5 / 1
P-60894-5	11 mm	142 mm	89 mm	5 / 1
P-60903-5	11,5 mm	142 mm	95 mm	5 / 1
P-60919-5	12 mm	151 mm	100 mm	5 / 1
P-60925-5	12,5 mm	151 mm	100 mm	5 / 1
P-60931-5	13 mm	151 mm	100 mm	5 / 1

# Pribor za bušenje

## Burgije HSS-G za metal, trostrani prihvat - dugačak

Visoki kvalitet HSS-G burgija za profesionalce. Ugao na vrhu 130° i saglasnosti sa DIN 1412C. Pogodne su za čelike, legirane odlivke i nelegirane čelike sa zateznom čvrstoćom do <950 N/mm<sup>2</sup>, ne-fertine metale, nerđajuće čelike i aluminijum.



Model	Prečnik	Ukupna dužina	Radna dužina	Kom/kompl
P-62496-10	1 mm	56 mm	33 mm	10 / 1
P-62505-10	1,5 mm	70 mm	50 mm	10 / 1
P-62511-10	2 mm	85 mm	54 mm	10 / 1
P-62527-10	2,5 mm	95 mm	61 mm	10 / 1
P-62533-10	3 mm	100 mm	67 mm	10 / 1
P-62549-10	3,5 mm	112 mm	75 mm	10 / 1
P-62555-10	4 mm	119 mm	78 mm	10 / 1
P-62561-10	4,5 mm	126 mm	81 mm	10 / 1
P-62577-10	5 mm	132 mm	87 mm	10 / 1
P-62583-10	5,5 mm	139 mm	91 mm	10 / 1
P-62599-10	6 mm	139 mm	91 mm	10 / 1
P-62608-10	6,5 mm	148 mm	97 mm	10 / 1
P-62614-10	7 mm	156 mm	102 mm	10 / 1
P-62620-10	7,5 mm	156 mm	102 mm	10 / 1
P-62636-10	8 mm	165 mm	109 mm	10 / 1
P-62642-5	8,5 mm	165 mm	109 mm	5 / 1
P-62658-5	9 mm	175 mm	115 mm	5 / 1
P-62664-5	9,5 mm	175 mm	115 mm	5 / 1
P-62670-5	10 mm	184 mm	123 mm	5 / 1
P-62686-5	10,5 mm	184 mm	123 mm	5 / 1
P-62701-5	11,5 mm	195 mm	128 mm	5 / 1
P-62717-5	12 mm	205 mm	135 mm	5 / 1
P-62723-5	12,5 mm	205 mm	135 mm	5 / 1
P-62739-5	13 mm	205 mm	135 mm	5 / 1

## Burgije HSS-Co (5%) za metal, cilindrični prihvat

HSS i HSS-G burgije legirane sa kobaltom. Kobalt obezbeđuje visoku otpornost na toplotu. Pogodne su za legirane i nelegirane čelike, nerđajuće čelike, liveno gvožđe, aluminijum, aluminijumske legure, bakar, mesing i bronzu.

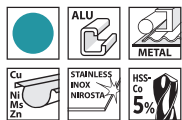

Model	Prečnik	Ukupna dužina	Radna dužina	Kom/kompl
D-17289	1,5 mm	40 mm	18 mm	1
D-17295	2 mm	49 mm	24 mm	1
D-17304	2,5 mm	57 mm	30 mm	1
D-17310	3 mm	61 mm	33 mm	1
D-17326	3,2 mm	65 mm	36 mm	1
D-17332	3,5 mm	70 mm	39 mm	1
D-17348	4 mm	75 mm	43 mm	1
D-17354	4,5 mm	80 mm	47 mm	1
D-17360	5 mm	86 mm	52 mm	1
D-17376	5,5 mm	93 mm	57 mm	1
D-17382	6 mm	93 mm	57 mm	1
D-17398	6,5 mm	101 mm	63 mm	1

D-17407	7 mm	109 mm	69 mm	1
D-17413	7,5 mm	109 mm	69 mm	1
D-17429	8 mm	117 mm	75 mm	1
D-17435	8,5 mm	117 mm	75 mm	1
D-17441	9 mm	125 mm	81 mm	1
D-17457	9,5 mm	125 mm	81 mm	1
D-17463	10 mm	133 mm	87 mm	1
D-17479	10,5 mm	133 mm	87 mm	1
D-17485	11 mm	142 mm	94 mm	1
D-17491	11,5 mm	142 mm	94 mm	1
D-17500	12 mm	151 mm	101 mm	1
D-17516	12,5 mm	151 mm	101 mm	1
D-17522	13 mm	151 mm	101 mm	1

## Burgije HSS-Co (5%) (visokog kvaliteta) za metal, cilindrični prihvat-dugačak

Visoko kvalitetna HSS-G burgija sa 5% kobaltom prema DIN 340 za profesionalne korisnike. Ugao na vrhu 130° - prema DIN 1412C. Čelici sa zateznom čvrstoćom do 1200 N/mm<sup>2</sup>. Pogodne su za legirane i nelegirane čelike, nerđajuće čelike, liveno gvožđe, aluminijum, aluminijumske legure, bakar, mesing i bronzu.



Model	Prečnik	Ukupna dužina	Radna dužina	Kom/kompl
P-62745-10	1 mm	56 mm	33 mm	10 / 1
P-62751-10	1,5 mm	70 mm	45 mm	10 / 1
P-62767-10	2 mm	85 mm	57 mm	10 / 1
P-62773-10	2,5 mm	95 mm	61 mm	10 / 1
P-62789-10	3 mm	100 mm	67 mm	10 / 1
P-62795-10	3,5 mm	112 mm	73 mm	10 / 1
P-62804-10	4 mm	119 mm	78 mm	10 / 1
P-62810-10	4,5 mm	126 mm	82 mm	10 / 1
P-62826-10	5 mm	132 mm	87 mm	10 / 1
P-62832-10	5,5 mm	139 mm	91 mm	10 / 1
P-62854-10	6,5 mm	148 mm	98 mm	10 / 1
P-62876-10	7,5 mm	156 mm	105 mm	10 / 1
P-62882-5	8 mm	165 mm	109 mm	5 / 1
P-62896-5	8,5 mm	165 mm	109 mm	5 / 1
P-62907-5	9 mm	175 mm	116 mm	5 / 1
P-62913-5	9,5 mm	175 mm	116 mm	5 / 1
P-62929-5	10 mm	184 mm	120 mm	5 / 1
P-62935-5	10,5 mm	184 mm	120 mm	5 / 1
P-62941-5	11 mm	195 mm	128 mm	5 / 1
P-62957-5	11,5 mm	195 mm	128 mm	5 / 1
P-62963-5	12 mm	205 mm	132 mm	5 / 1
P-62979-5	12,5 mm	205 mm	132 mm	5 / 1
P-62985-5	13 mm	205 mm	132 mm	5 / 1

- Akumulat orni i punjači
- Pribor za akumulat orske alate
- Akumulat orske lampe i pribor
- Pribor za lasarske merace
- Pribor za rušenje i udarno bušenje
- Pribor za bušenje
- Krunaste testere
- Pribor za pritezanje
- Pribor za sečenje i brušenje
- Pribor za brušenje i poliranje
- Pribor za profilisanje i poravnaj
- Pribor za višenamenski alat
- Pribor za testere
- Pribor za pneumatske alate
- Pribor za fenove za vrući vazduh
- Pribor za usisivanje
- Pribor za alate za rad na otvoreno
- Pribor za držače alata i zaštitna
- Koferi i torbe
- Ručni alati
- Ostalo
- Pribor za mješanje

# Pribor za bušenje

## Burgije HSS-Co (8%) (visokog kvaliteta) za metal, cilindrični prihvat

Visoko kvalitetna HSS-G burgija sa 8% kobalta prema DIN 338 za profesionalne korisnike. Ugao na vrhu 130° - prema DIN 1412C. Čelici sa zateznom čvrstoćom do 1400 N/mm<sup>2</sup>. Pogodne su za legirane i nelegirane čelike, nerđajuće čelike, liveno gvožđe, aluminijum, aluminijumske legure, bakar, mesing i bronzu.

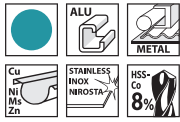

Model	Prečnik	Ukupna dužina	Radna dužina	Kom/kompl
P-61846-10	1 mm	34 mm	13 mm	10 / 1
P-61868-10	1,5 mm	40 mm	19 mm	10 / 1
P-61880-10	2 mm	49 mm	24 mm	10 / 1
P-61905-10	2,5 mm	57 mm	30 mm	10 / 1
P-61927-10	3 mm	61 mm	34 mm	10 / 1
P-61949-10	3,5 mm	70 mm	39 mm	10 / 1
P-61961-10	4 mm	75 mm	44 mm	10 / 1
P-61983-10	4,5 mm	80 mm	46 mm	10 / 1
P-62000-10	5 mm	86 mm	52 mm	10 / 1
P-62022-10	5,5 mm	93 mm	57 mm	10 / 1
P-62066-10	6,5 mm	101 mm	63 mm	10 / 1
P-62088-10	7 mm	109 mm	70 mm	10 / 1
P-62094-10	7,5 mm	109 mm	70 mm	10 / 1
P-62119-10	8,5 mm	117 mm	76 mm	10 / 1
P-62125-10	9 mm	125 mm	82 mm	10 / 1
P-62131-10	9,5 mm	125 mm	82 mm	10 / 1
P-62147-10	10 mm	133 mm	87 mm	10 / 1
P-62153-5	10,5 mm	133 mm	87 mm	5 / 1
P-62169-5	11 mm	142 mm	94 mm	5 / 1
P-62175-5	11,5 mm	142 mm	94 mm	5 / 1
P-62181-5	12 mm	151 mm	100 mm	5 / 1
P-62197-5	12,5 mm	151 mm	100 mm	5 / 1
P-62206-5	13 mm	151 mm	100 mm	5 / 1

## Burgije HSS-G-TiN za metal, cilindrični prihvat

Karakteristike i prednosti TiN (titanijum-nitrid) TiN (titanijum-nitrid) je hemisko jedinjenje titanijuma i azota, koje postiže nisko trenje. Zbog toga je primerljivo za aplikacije sa vrlo niskim habanjem. Legura se karakteriše sa sledećim pozitivnim karakteristikama:  
 • Dugačak vek • Visoka tvrdoća i otpornost na koroziju • Povećana brzina bušenja  
 • Onemogućeno je lepljenje strugotine po reznom rubu Pogodna je za nerđajuće čelike, legirane i nelegirane čelike i liveno gvožđe. TiN HSS-G burgije u saglasnosti sa DIN 338, Ugao na vrhu 135°, za čelike sa zateznom čvrstoćom do <900 N/mm<sup>2</sup>.

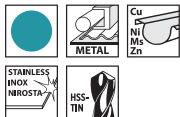

Model	Prečnik	Ukupna dužina	Radna dužina	Kom/kompl
P-60981-10	1 mm	34 mm	11 mm	10 / 1
P-61008-10	1,5 mm	40 mm	19 mm	10 / 1
P-61020-10	2 mm	49 mm	23 mm	10 / 1
P-61042-10	2,5 mm	57 mm	32 mm	10 / 1
P-61064-10	3 mm	61 mm	33 mm	10 / 1
P-61086-10	3,5 mm	70 mm	39 mm	10 / 1
P-61101-10	4 mm	75 mm	43 mm	10 / 1
P-61123-10	4,5 mm	80 mm	47 mm	10 / 1
P-61145-10	5 mm	86 mm	51 mm	10 / 1
P-61167-10	5,5 mm	93 mm	57 mm	10 / 1

P-61189-10	6 mm	93 mm	57 mm	10 / 1
P-61204-10	6,5 mm	101 mm	63 mm	10 / 1
P-61226-10	7 mm	109 mm	68 mm	10 / 1
P-61248-10	7,5 mm	109 mm	68 mm	10 / 1
P-61260-10	8 mm	117 mm	74 mm	10 / 1
P-61282-10	8,5 mm	117 mm	74 mm	10 / 1
P-61298-10	9 mm	125 mm	80 mm	10 / 1
P-61307-5	9,5 mm	125 mm	80 mm	5 / 1
P-61313-10	10 mm	133 mm	86 mm	10 / 1
P-61329-5	10,5 mm	133 mm	86 mm	5 / 1
P-61335-5	11 mm	142 mm	94 mm	5 / 1
P-61341-5	11,5 mm	142 mm	94 mm	5 / 1
P-61357-5	12 mm	151 mm	101 mm	5 / 1
P-61367-5	12,5 mm	151 mm	101 mm	5 / 1
P-61379-5	13 mm	151 mm	101 mm	5 / 1

## Burgije HSS-TiN (visokog kvaliteta) za metal, 1/4" prihvat



Model	Prečnik	Ukupna dužina	Radna dužina	Kom/kompl
B-50893	3,2 mm	67 mm	29 mm	1
B-50918	3,5 mm	70 mm	29 mm	1
B-50924	4 mm	71 mm	30 mm	1
B-50930	4,2 mm	71 mm	31 mm	1
B-50946	4,5 mm	75 mm	31 mm	1
B-50968	5,5 mm	78 mm	35 mm	1
B-50980	6,5 mm	81 mm	38 mm	1
B-50996	7 mm	89 mm	45 mm	1
B-51007	7,5 mm	95 mm	50 mm	1
B-51029	8,5 mm	102 mm	50 mm	1
B-51035	9 mm	102 mm	50 mm	1
B-51041	10 mm	102 mm	50 mm	1
B-51057	11 mm	102 mm	50 mm	1
B-51063	12 mm	102 mm	50 mm	1
B-51079	13 mm	102 mm	50 mm	1

## Burgije HSS-TiN za metal, 1/4" prihvat

Titanijum nitridni sloj za duži radni vek. 1/4" šestougaono stablo pogodno za sistem sa brzim izmenom i šestougaonim prihvatom. Prečnici od 3 - 13 mm.



Model	Prečnik	Ukupna dužina	Radna dužina	Kom/kompl
D-14928	3 mm	61 mm	33 mm	1
D-14934	3,2 mm	85 mm	36 mm	1
D-16081	3,3 mm	85 mm	36 mm	1
D-14940	4 mm	95 mm	43 mm	1
D-14956	4,2 mm	95 mm	43 mm	1
D-14962	5 mm	106 mm	52 mm	1
D-14978	6 mm	113 mm	57 mm	1
D-15827	8 mm	117 mm	75 mm	1



# Pribor za bušenje

D-15833	10 mm	133 mm	87 mm	1
D-15849	12 mm	151 mm	101 mm	1
D-15855	13 mm	151 mm	101 mm	1

## Burgija za zakivke

Burgija za zakivke omogućava rad u tesnim i uskim prostorima. Koriste je montažeri klima-uređaja, vodoinstalateri, limari itd.



Model	Prečnik	Dužina	Prihvat	Kom/kompl
B-56437	3,3 mm	50 mm	1/4" MZ	10 / 1

## Stepenaste burgije HSS-G sa spiralnim žljebom



Model	Prečnik	Pogodno za
P-69892	4-12 mm	Ne legirani čelik, nerđajući čelik, liveno gvožđe i čelik < 800 N/mm <sup>2</sup> zatezna čvrstoća
P-69901	4-20 mm	
P-69917	4-30 mm	

## Stepenaste burgije HSS-Co-TiALN sa spiralnim žljebom



Model	Prečnik	Pogodno za
P-69967	4-12 mm	Ne legirani čelik, nerđajući čelik, liveno gvožđe i čelik < 1.400 N/mm <sup>2</sup> zatezna čvrstoća
P-69973	4-20 mm	
P-69989	4-30 mm	

## HSS zabušivači



Model	Prečnik	Visina koraka	Tip vijka
P-73514	4,3 mm	90 °	M2
P-73520	5,3 mm	90 °	M2.5
P-73536	6,3 mm	90 °	M3
P-73542	8,3 mm	90 °	M4
P-73558	9,4 mm	90 °	M4.5
P-73564	10,4 mm	90 °	M5
P-73570	12,4 mm	90 °	M6
P-73586	16,5 mm	90 °	M8

## HSS-Co zabušivači

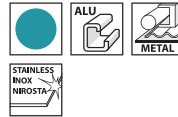

Model	Prečnik	Visina koraka	Tip vijka
P-73601	6,3 mm	90 °	M3
P-73617	8,3 mm	90 °	M4
P-73623	10,4 mm	90 °	M5
P-73639	12,4 mm	90 °	M6
P-73645	16,5 mm	90 °	M8

## Komplet od 6-komada HSS upuštača u metalnoj kutiji

Običan tip upuštača sa cilindričnim prihvatom. Upuštač sa tri rezna ruba i dugačkim zupcima za duboko upuštanje.

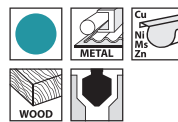

Model	Prihvat	Opis
D-42204	5,6,8,10 mm	6,3x45 mm (M3), 8,3x50 mm (M4), 10,4x50 mm (M5), 12,4x56 mm (M6), 16,5x60 mm (M8), 20,5x63 mm (M10)

## Burgije za zid

### Burgije za zid, cilindrični prihvat

Značajan kružnosti rupe? Rupa nije samo rupa. Tradicionalne burgije imaju tendenciju da „šetaju“ što rezultuje sa trouglastom rupom, koja je u stvari veća nego što treba – to znači da stezanje neće da bude sigurno. Burgije koje prave kružnu rupu treba da se koriste kada je to potrebno, posebno kada se postavljaju kritični spojevi kao što su ankeri.



Model	Prečnik	Ukupna dužina	Radna dužina
D-05234	4 mm	70 mm	35 mm
D-05240	5 mm	85 mm	45 mm
D-05256	6 mm	100 mm	60 mm
D-05262	6 mm	150 mm	90 mm
D-05290	8 mm	110 mm	60 mm
D-05309	8 mm	150 mm	90 mm
D-05321	10 mm	150 mm	90 mm
D-05343	12 mm	150 mm	90 mm
D-17728	12 mm	600 mm	505 mm
D-05359	13 mm	150 mm	85 mm
D-05365	14 mm	150 mm	85 mm
D-05371	15 mm	150 mm	85 mm
D-17734	16 mm	600 mm	505 mm

Akumulat  
ori i  
punjači

Pribor za  
akumulat  
orske  
alatne  
priloge

Akumulat  
orske  
lampe i  
priloge

Pribor za  
laserske  
merace

Pribor za  
rušenje i  
udarno  
bušenje

Pribor za  
bušenje

Krunaste  
testere

Pribor za  
pritazani  
e

Pribor za  
sečenje i  
bušenje

Pribor za  
bušenje  
i  
poliranje

Pribor za  
profilisanje  
i  
poravnane

Pribor za  
višenam  
enski alat

Pribor za  
testere

Pribor za  
pneumat  
ske alate

Pribor za  
fenove  
za vrući  
vazduh

Pribor za  
usisivanje

Pribor za  
alate za  
rad na  
otvoreno

Pribor za  
držače  
alata i  
zaštitna

Koferi i  
torbe

Ručni  
alati

Ostalo

Pribor za  
mješanje

# Pribor za bušenje

## Burgije za zid (visokog kvaliteta) sa cilindričnim prihvatom

Otporne na udarce profesionalne burgije za beton i kamen sa reznim rubovima od tvrdog metala prema DIN 8039. Pogodne za prirodni kamen, građevinski materijal i beton. Ugao na vrhu 130°.

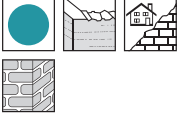

Model	Prečnik	Ukupna dužina	Radna dužina
P-59592	3 mm	60 mm	35 mm
P-59601	4 mm	75 mm	45 mm
P-59617	5 mm	85 mm	50 mm
P-59623	6 mm	100 mm	60 mm
P-59798	6 mm	400 mm	220 mm
P-59639	7 mm	100 mm	60 mm
P-59645	8 mm	120 mm	80 mm
P-59760	8 mm	200 mm	130 mm
P-59807	8 mm	400 mm	220 mm
P-59651	9 mm	120 mm	80 mm
P-59667	10 mm	120 mm	80 mm
P-59776	10 mm	200 mm	140 mm
P-59813	10 mm	400 mm	220 mm
P-59673	11 mm	150 mm	90 mm
P-59782	12 mm	200 mm	140 mm
P-59829	12 mm	400 mm	230 mm
P-59922	12 mm	600 mm	550 mm
P-59695	13 mm	150 mm	90 mm
P-59835	14 mm	400 mm	350 mm
P-59710	16 mm	150 mm	90 mm
P-59841	16 mm	400 mm	350 mm
P-59944	16 mm	600 mm	540 mm
P-59726	18 mm	160 mm	100 mm
P-59857	18 mm	400 mm	350 mm
P-59950	18 mm	600 mm	550 mm
P-59732	20 mm	160 mm	110 mm
P-59863	20 mm	400 mm	330 mm
P-59966	20 mm	600 mm	550 mm
P-59748	22 mm	160 mm	110 mm
P-59879	22 mm	400 mm	350 mm
P-59885	25 mm	400 mm	330 mm

## Burgije za staklo

### Burgije za staklo, 1/4" prihvat

Makita burgije za staklo sa glavom sa šiljatom vrhom obezbeđuju odlično sečenje u staklu i keramici. Idealne su za rad u kuhinji i kupatilu.



Model	Prečnik	Ukupna dužina	Delovna dužina
D-15942	4 mm	65 mm	/
D-15958	5 mm	65 mm	/
D-15964	6 mm	65 mm	/
D-15970	8 mm	70 mm	/
D-15986	10 mm	80 mm	/

## Univerzalne burgije

### Univerzalne burgije, cilindrični prihvat ★★★

Vrh od volfram karbida. Pogodne za različite vrste materijala.

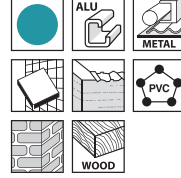

Model	Prečnik	Ukupna dužina	Radna dužina
E-10958	3 mm	70 mm	38 mm
E-10964	4 mm	75 mm	40 mm
E-10970	5 mm	85 mm	43 mm
E-10986	5.5 mm	100 mm	50 mm
E-10992	6 mm	100 mm	50 mm
E-11003	6 mm	150 mm	90 mm
E-11019	6.5 mm	100 mm	50 mm
E-11025	6.5 mm	150 mm	90 mm
E-11031	7 mm	100 mm	50 mm
E-11047	8 mm	120 mm	60 mm
E-11053	8 mm	150 mm	90 mm
E-11069	10 mm	150 mm	90 mm
E-11075	12 mm	150 mm	90 mm
E-11081	13 mm	150 mm	90 mm

### Univerzalne burgije, cilindrični prihvat ★★

Vrh od volfram karbida. Pogodne za različite vrste materijala. Ne preporučuje se rad sa aluminijumskim materijalima kada je vrh istrošen. Uvek koristite nove burgije kada radite sa aluminijumskim materijalima.

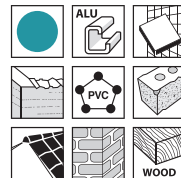

Model	Prečnik	Ukupna dužina	Radna dužina
D-71875	3 mm	60 mm	28 mm
D-71881	4 mm	70 mm	35 mm
D-71897	5 mm	85 mm	43 mm
D-71906	6 mm	100 mm	58 mm
D-71912	6 mm	150 mm	108 mm
D-71928	8 mm	110 mm	57 mm
D-71934	8 mm	150 mm	97 mm
D-71940	10 mm	150 mm	97 mm

Akumulatori i punjači

Pribor za akumulatorske alate

Akumulatorske lampe i pribor

Pribor za laserske merace

Pribor za rušenje i udarno bušenje

Pribor za bušenje

Krunaste testere

Pribor za pritezanje

Pribor za sečenje i brušenje

Pribor za brušenje i poliranje

Pribor za profilisanje i poravnavanje

Pribor za višenamenski alat

Pribor za testere

Pribor za pneumatske alate

Pribor za fenove za vrući vazduh

Pribor za usisivanje

Pribor za alate za rad na otvoreno

Pribor za držače alata i zaštitna

Koferi i torbe

Ručni alati

Ostalo

Pribor za mješanje

# Pribor za bušenje

## Umetci za bušenje i odvrtnje

Umetci za bušenje, upuštanje i odvrtnje u jednom. Umetci imaju podesivu dubinu bušenja.

### Umetci za bušenje i odvrtnje



Model	Upuštač	Prečnik burgije	Dubina bušenja	Umetak
D-73209	Št. 6 (M3)	2,4 mm	11 - 31 mm	PH2
D-73215	Št. 8 (M4)	2,8 mm	18 - 38 mm	PH2
D-73221	Št. 10 (M5)	3,2 mm	22 - 41 mm	PH2

### Rezervni upuštači sa burgijom



Model	Upuštač	Prečnik burgije	Dubina bušenja	Umetak
D-73237	Št. 6 (M3)	2,4 mm	11 - 31 mm	D-73209
D-73243	Št. 8 (M4)	2,8 mm	18 - 38 mm	D-73215
D-73259	Št. 10 (M5)	3,2 mm	22 - 41 mm	D-73221

### 4-delni komplet upuštača sa burgijom

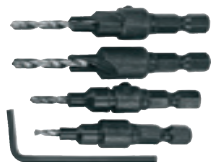

Model	Upuštač	Prečnik burgije	Dubina bušenja
D-73455	Št. 6 (M3)	2,4 mm	11 - 31 mm
	Št. 8 (M4)	2,8 mm	18 - 38 mm
	Št. 10 (M5)	3,2 mm	22 - 41 mm
	Št. 12 (M6)	3,6 mm	26 - 45 mm

## Dijamantske krune

### Dijamantske krune, za mokro bušenje



Model	Prečnik	Dubina bušenja	Prihvati
P-65816	62 mm	400 mm	UNC 5/4"
P-41090	92 mm	400 mm	UNC 5/4"
P-41115	102 mm	400 mm	UNC 5/4"
P-41143	112 mm	400 mm	UNC 5/4"
P-41159	117 mm	400 mm	UNC 5/4"

P-65822	122 mm	400 mm	UNC 5/4"
P-65838	132 mm	400 mm	UNC 5/4"
P-41171	152 mm	400 mm	UNC 5/4"
P-41187	162 mm	400 mm	UNC 5/4"
P-41202	182 mm	400 mm	UNC 5/4"
P-41224	212 mm	400 mm	UNC 5/4"
P-41230	225 mm	400 mm	UNC 5/4"

## Adapteri i produžeci

Model	Opis	Slika
P-14015	Adapter 5/4"-M30 za model DBM230	
P-41626	Produžetak za dijamantske krune, 300mm za model DBM230	

## Stalci i pribor

Model	Opis	Slika
P-40082	Postolja za model DBM130, DBM131	
P-54190	Postolja za model DBM230	
P-54178	Prsten sakupljača vode za model DBM230	
P-54184	Adapter za prsten sakupljača vode za model DBM230	
P-40098	Komplet za pritezanje postolja P-54190	
P-54221	Usisni pribor za postolja P-54190	

Akumulat orni punjači  
Pribor za akumulat orske alate  
Akumulat orske lampe i pribor  
Pribor za laserske merace  
Pribor za rušenje i udarno bušenje  
Pribor za bušenje  
Krunaste testere  
Pribor za pritezanje  
Pribor za sečenje i brusenje  
Pribor za brusenje i poliranje  
Pribor za profilisanje i poravnanje  
Pribor za višenamenski alat  
Pribor za testere  
Pribor za pneumatske alate  
Pribor za fenove za vrući vazduh  
Pribor za usisivanje  
Pribor za alate za rad na otvoreno  
Pribor za držače alata i zaštitna  
Koferi i torbe  
Ručni alati  
Ostalo  
Pribor za mješanje

## Krone za magnetne bušilice

### Krone za magnetne bušilice, 19 mm Weldon prihvat



Model	Prečnik	Radna dužina	Za model
HB-13S	13 mm	25 mm	HB500, HB350
HB-14S	14 mm	25 mm	HB500, HB350
HB-15S	15 mm	25 mm	HB500, HB350
HB-16S	16 mm	25 mm	HB500, HB350
HB-17S	17 mm	25 mm	HB500, HB350
HB-18S	18 mm	25 mm	HB500, HB350
HB-19S	19 mm	25 mm	HB500, HB350
HB-20S	20 mm	25 mm	HB500, HB350
HB-22S	22 mm	25 mm	HB500, HB350
HB-24S	24 mm	25 mm	HB500, HB350
HB-25S	25 mm	25 mm	HB500, HB350
HB-26S	26 mm	25 mm	HB500, HB350
HB-28S	28 mm	25 mm	HB500, HB350
HB-30S	30 mm	25 mm	HB500, HB350
HB-32S	32 mm	25 mm	HB500, HB350
HB-20L	20 mm	50 mm	HB500
HB-22L	22 mm	50 mm	HB500
HB-24L	24 mm	50 mm	HB500
HB-28L	28 mm	50 mm	HB500
HB-30L	30 mm	50 mm	HB500
HB-32L	32 mm	50 mm	HB500
HB-34L	34 mm	50 mm	HB500
HB-35L	35 mm	50 mm	HB500
HB-36L	36 mm	50 mm	HB500
HB-42L	42 mm	50 mm	HB500
HB-45L	45 mm	50 mm	HB500
HB-50L	50 mm	50 mm	HB500

### Kružni alat za krone za magnetne bušilice



Model	Prečnik	Radna dužina	Za model
HB-PILOTS	/ mm	25 mm	HB500, HB350
HB-PILOTL	/ mm	50 mm	HB500

## Burgije za zemlju za udarne odvijače

### Burgije za zemlju



Model	Prečnik	Ukupna dužina	Radna dužina	Prihvat
B-54346	20 mm	600 mm	530 mm	3/4" kvadratni prihvat
B-54352	25 mm	600 mm	530 mm	3/4" kvadratni prihvat
B-54368	30 mm	600 mm	530 mm	3/4" kvadratni prihvat
B-54374	35 mm	600 mm	530 mm	3/4" kvadratni prihvat
B-57576*	40 mm	600 mm	530 mm	3/4" kvadratni prihvat
B-57582	40 mm	600 mm	530 mm	3/4" kvadratni prihvat

\*Ima nasadni ključ, o-prsten i štift

### Pribor za burgije za zemlju

Model	Opis	Slika
B-54380	Nasadni ključ za burgiju za zemlju - 3/4" kvadratni prihvat	
B-54396	Štift za 3/4" nasadni ključ	
B-54405	O-prsten za 3/4" nasadni ključ	

## Burgije za zemlju za odvijače

### Burgije za zemlju

Obavezna upotreba sa bočnom drškom



Model	Prečnik	Ukupna dužina	Radna dužina	Prihvat
D-75415	30 mm	600 mm	200 mm	11,8 mm HEX
D-75421	45 mm	600 mm	200 mm	11,8 mm HEX
D-75437	70 mm	600 mm	200 mm	11,8 mm HEX

## Stezne glave za bušenje

### Brzostezne glave

Model	Kapacitet (mm)	Veličina navoja	Za model	Cena sa PDV-om	
193203-4	0,5-6,5	3/8"-24 UNF	6501, 6501X, DP2010, DP2011		
196309-7	0,8-10	1/2"-20 UNF	DDF343, DHP343, 6281,6271, 6261		
763181-8	0,8-10	1/2"-20 UNF	MT064		
763187-6	0,8-10	1/2"-20 UNF	6260D, 6270D, 6280D, 6207D, 8270D, 8280D, 8270DW		
763228-8	0,8-10	3/8"-24 UNF	DF330D, HP330D, DDA341, DDA351, DF331D, HP331D		
763229-6	0,8-10	1/2"-20 UNF	8291, 8281, 8271, BHP343, DHP343, HP330D, HP331D, HP347D		
766009-9	0,8-10	1/2"-20 UNF	6207DWDE		
766012-0	0,8-10	1/2"-20 UNF	MT080, DF0300, HP0300		
766013-8	1 - 13	1/2"-20 UNF	MT081E		
192284-5	1,5-13	1/2"-20 UNF	6211D, 6311D		
192685-7	1,5-13	1/2"-20 UNF	HP2041		
194254-0	1,5-13	1/2"-20 UNF	HP2051, HP2051H, HP2071, DP4011, HB500		

Nastavak...

- Akumulat
- Pribor za akumulat
- Akumulat
- Pribor za laserske
- Pribor za rušenje i udarno bušenje
- Pribor za bušenje
- Krunaste testere
- Pribor za pritezanje
- Pribor za sečenje i brusenje
- Pribor za brusenje i poliranje
- Pribor za profilisanje i poravnavanje
- Pribor za višenamenski alat
- Pribor za testere
- Pribor za pneumatike alate
- Pribor za fenove za vrući vazduh
- Pribor za usisivanje
- Pribor za alate za rad na otvoreno
- Pribor za držače alata i zaštitna
- Koferi i torbe
- Ručni alati
- Ostalo
- Pribor za mješanje

# Pribor za bušenje

	Model	Kapacitet (mm)	Veličina navoja	Za model	Cena sa PDV-om
Pribor za bušenje i udarno bušenje	 196193-0	1,5-13	1/2"-20 UNF	HP1631, HP1641	
Pribor za bušenje i udarno bušenje	 196306-3	1,5-13	1/2"-20 UNF	DDF453, DHP453, DF457D, HP457D, 6391, 8391, 6381, 8381	
Pribor za bušenje i udarno bušenje	 763158-3	1,5-13	1/2"-20 UNF	DP4001, DP4003, DP4700, 6317, 6337, 6347	
Pribor za bušenje	 763178-7	1,5-13	1/2"-20 UNF	6390D, 8390D	
Pribor za bušenje i udarno bušenje	 763191-5	1,5-13	1/2"-20 UNF	DHP451, DHP454	
Pribor za bušenje i udarno bušenje	 763196-5	1,5-13	1/2"-20 UNF	DDF451, DHP451, DDF441, DHP44, DDF444, DDF454, DHP444, DHP454	
Pribor za bušenje i udarno bušenje	 763248-2	1,5-13	1/2"-20 UNF	DDF448, DDF458, DDF481, DHP448, DHP458, DHP481	
Pribor za bušenje i udarno bušenje	 763256-3	1,5-13	1/2"-20 UNF	DDF484, DHP482, DF002G, HP002G	
Pribor za bušenje i udarno bušenje	 766019-6	1,5-13	1/2"-20 UNF	MT818, M8104	
Pribor za bušenje i udarno bušenje	 766027-7	1,5-13	1/2"-20 UNF	DDF446, DDF456, DHP484, DHP485	
Pribor za bušenje i udarno bušenje	 P-15718	1,5-13	1/2"-20 UNF	6013B, 6013BR, 6300-4, DP4001, DP4003, DP4700, HP1620-HP1621K, HP2050-HP2051F, HP2070-HP2071F	
Pribor za bušenje i udarno bušenje	 196307-1	10	1/2"-20 UNF	6260, 6270, 6280D	
Pribor za bušenje i udarno bušenje	 193226-2	1-10	1/2"-20 UNF	DP3003	

Nastavak...

# Pribor za bušenje

Model	Kapacitet (mm)	Veličina navoja	Za model	Cena sa PDV-om	
766026-9	1-10	3/8"-24 UNF	MT607, M6002		
193064-2	1-13	1/2"-20 UNF	DDF460, DHP460		

## Stezne glave sa nazubljenim vencem

Model	Kapacitet (mm)	Prihvata	Za model	Cena sa PDV-om	
P-04313	0,5-10	3/8"-24 UNF	6408, 6410, 6510LVR		
192887-5	0,5-6,5	3/8"-24 UNF	6501, DP2010		
192879-4	1,5-10	3/8"-24 UNF	6510PB		
763174-5	1,5-10	1/2"-20UNF	DA3010, DDA350, DDA340		
192883-3	1,5-13	5/8"-16 UNF	DA6301		
766016-2	1,5-13	1/2"-20 UNF	HP1630, HP1640		
193822-6	1-13	1/2"-20UNF	DS4010, DS4011, HP2050, HP2070, HB500, 6300-4, DP4700		
192877-8	2-13	1/2"-20 UNF	6305		
193318-7	2-13	Glava s vratilom	DA4000LR		

Akumulat  
ori i  
punjači

Pribor za  
akumulat  
orske  
alate

Akumulat  
orske  
lampe i  
pribor

Pribor za  
laserske  
merace

Pribor za  
rušenje i  
udarno  
bušenje

Pribor za  
bušenje

Krunaste  
testere

Pribor za  
pritezanje

Pribor za  
sečenje i  
brusjenje

Pribor za  
brusjenje  
i  
poliranje

Pribor za  
profilisanje  
i  
poravnanje

Pribor za  
višenam  
enski alat

Pribor za  
testere

Pribor za  
pneumat  
ske alate

Pribor za  
fenove  
za vrući  
vazduh

Pribor za  
usisivanje

Pribor za  
alate za  
rad na  
otvoreno

Pribor za  
držače  
alata i  
zaštitna

Koferi i  
torbe

Ručni  
alati

Ostalo

Pribor za  
mješanje

# Pribor za bušenje

## Stezne glave za bušilicu, 1/4" prihvat

	Model	Kapacitet (mm)	Prihvat	Za model	Cena sa PDV-om
	192075-4	0,5-10	1/4" (6,35 mm) ISO	BTP, DTP, BTD, DTD, TD	

## Pribor za stezne glave za bušenje

	Model	Naziv	Za model	Cena sa PDV-om
	410102-8	Držač ključa za futer	763430-3, 763432-9	
	411780-7	Držač ključa za futer	763418-3, 763415-9	
	418163-2	Držač ključa za futer	763441-8, 763418-3	
	763415-9	Ključ za futer, 10mm	763174-5	
	763418-3	Ključ za futer	192887-5	
	763432-9	Ključ za futer, 13mm	P-04329, 192877-8, 192883-3, 193318-7	



# KRUNASTE TESTERE

<p><b>Ezychange</b> Bi-Metal HSS 8%Co</p> <p><b>Ezychange</b> TCT</p>	<p>Bi-metalne krunaste testere</p>	<p>Bi-metalne krunaste testere za lim</p>
<p>Ezychange adapter</p> <p>Ezychange adapter</p>	<p>Standardni adapter</p> <p>Varirajuće rastojanje između zubaca</p> <p>HSS Bi Metal</p>	<p>HSS Bi Metal Co 8%</p> <p>Varirajuće rastojanje između zubaca</p> <p>Opruga za izbacivanje zaostalog materijala</p> <p>Grafičnik apsorbuje udarac kada kruna prolazi kroz materijal</p>
<p>Višenamenske TCT krunaste testere</p>	<p>Krunaste testere od volfram karbida</p>	<p>Dijamantske krune za mokro bušenje tvrde keramike</p>
<p>TCT</p> <p>Zahvaljujući izvedbi krune sa umekšanim uglovima, drveni opiljak se brzo izbacuje</p>	<p>Standardni adapter</p> <p>Veliki broj zrna (20-30) omogućava brzo i glatko bušenje</p>	<p>Standardni adapter</p> <p>Dijamantski pesak za brže bušenje i duži vek trajanja</p>

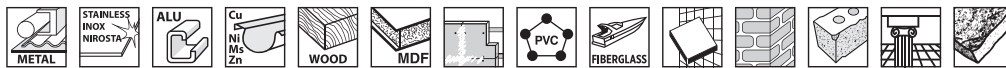

Primena		Metali	Nerđajući čelik	Aluminijum	Oboljeni metali	Drvo	MDF	Gips ploče	Plastika, PVC	Staklena vlakna	Keramičke pločice	Cigla	Kretnjak	Mermer	Granit
Bim	<b>Ezychange</b> Bi-Metal HSS 8%Co	★★	★	★★		★★			★★						
	Bi-Metal	★★		★	★	★★			★★						
	Bi-Metal za tanke limove	★★	★★		★										
Volfram karbid	<b>Ezychange</b> TCT	★★	★★			★★			★★		★	★			
	Višenamenske TCT					★★	★★	★★	★★	★★	★		★		
	Sa granulacijom od volframov karbida										★★	★★			
Dijamantske	Za bušenje u tvrdoj keramici										★★			★★	★★

★★: Preporučljivo ★: Prihvatljivo

## EZYCHANGE KRUNASTE TESTERE

# Ezychange



**SAMO JEDAN KLIK ZA PROMENU KRUŽNE TESTERE**

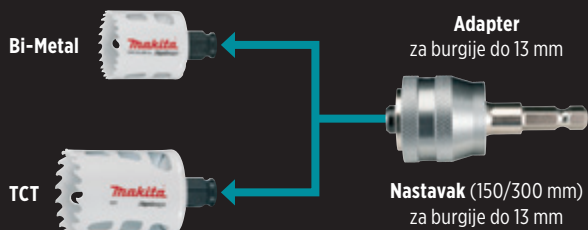

**JEDNOSTAVNO UKLANJANJE OTPADAKA POMOĆU BURGJE**

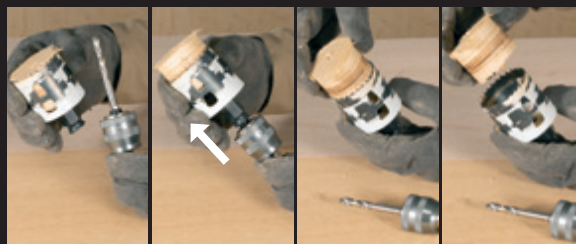

## Ezychange

### Bi-Metal HSS 8%Co

Progresivna geometrija zuba za brže rezanje.

Zahvaljujući dubini rezanja od 44 mm korisnici sa sigurnošću mogu da izrežu materijal od 38 mm.

Može se rezati u nerđajući čelik debljine 3 mm.



## Ezychange

### TCT

TCT zubi za veću izdržljivost.

Radna dužina 60 mm za rezanje 50x100 mm u jednom prolazu. Takođe se može iseći u WPC (kompozit od drveta i plastike).

Može rezati nerđajući čelik debljine 3 mm i veći raspon drugih materijala u poređenju sa BiM-om.



## Ezchange HSS-BiM kružne testera sa 8%Co



### Ezchange HSS-BiM kružne testera sa 8%Co

Potreban je samo jedan nosač u opsegu od 16 - 152 mm sa brzo steznom burgijom sa vođenjem i krunastim telom. Ovo ne omogućava samo brze izmene veće i sigurniji metod za korisnika. Proizvedene od HSS bi-metala sa 8% kobalta, pogodne su za crne i obojene metale, nerđajuće čelike, aluminijum, drvo i plastiku.



Model	Prečnik Ø (mm)	Dubina bušenja (mm)	Broj obrtaja za metal (min <sup>-1</sup> )	Broj obrtaja za nerđajuće čelike (min <sup>-1</sup> )	Broj obrtaja za aluminijum (min <sup>-1</sup> )	Broj obrtaja za drvo (min <sup>-1</sup> )	RPM - plastika (min <sup>-1</sup> )	Cena sa PDV-om
E-03632	16	44	530	275	825	3.000	3.000	
E-03648	17	44	500	250	750	3.000	3.000	
E-03654	19	44	460	230	690	3.000	3.000	
E-03660	20	44	440	220	675	3.000	3.000	
E-03676	22	44	390	195	580	3.000	3.000	
E-03682	24	44	370	185	555	2.700	2.700	
E-03698	25	44	350	175	525	2.700	2.700	
E-03707	27	44	325	160	480	2.700	2.700	
E-03713	29	44	300	150	450	2.700	2.700	
E-03729	30	44	285	145	425	2.400	2.400	
E-03735	32	44	275	140	410	2.400	2.400	
E-03741	35	44	250	125	375	2.400	2.400	
E-03757	37	44	240	120	360	2.400	2.400	
E-03763	38	44	230	115	345	2.400	2.400	
E-03779	40	44	220	110	330	2.100	2.100	
E-03785	41	44	210	105	315	2.100	2.100	
E-03791	44	44	195	95	295	2.100	2.100	
E-03800	46	44	190	95	285	2.100	2.100	
E-03816	48	44	180	90	270	2.100	2.100	
E-03822	51	44	170	85	255	2.000	2.000	
E-03838	52	44	165	80	240	2.000	2.000	
E-03844	54	44	160	80	240	2.000	2.000	
E-03850	56	44	155	80	240	2.000	2.000	
E-03866	57	44	150	75	225	2.000	2.000	
E-03872	60	44	140	70	220	2.000	2.000	
E-03888	64	44	135	65	205	1.850	1.850	
E-03894	65	44	130	65	200	1.850	1.850	
E-03903	68	44	130	65	190	1.800	1.800	
E-03919	70	44	125	60	185	1.800	1.800	
E-03925	73	44	120	60	180	1.800	1.800	
E-03931	76	44	115	55	170	1.800	1.800	
E-03947	79	44	110	55	165	1.500	1.500	
E-03953	83	44	105	50	155	1.500	1.500	
E-03969	86	44	100	50	150	1.500	1.500	
E-03975	92	44	90	45	140	1.200	1.200	
E-03981	95	44	90	45	135	1.200	1.200	
E-03997	102	44	85	40	130	1.000	1.000	
E-04008	105	44	80	40	120	1.000	1.000	
E-04014	111	44	80	40	120	900	900	
E-04020	114	44	75	35	105	900	900	
E-04036	121	44	75	35	95	900	900	
E-04042	127	44	65	30	90	800	800	

Nastavak...

Akumulatori i punjači

Pribor za akumulatorske alate

Akumulatorne lampe i pribor

Pribor za laserske merace

Pribor za rušenje i udarno bušenje

Pribor za bušenje

Krunaste testere

Pribor za pritezanje

Pribor za sečenje i brušenje

Pribor za brušenje i poliranje

Pribor za profilisanje i poravnavanje

Pribor za višenamenski alat

Pribor za testere

Pribor za pneumatske alate

Pribor za fenove za vrući vazduh

Pribor za usisivanje

Pribor za alate za rad na otvoreno

Pribor za držače alata i zaštitna

Koferi i torbe

Ručni alati



Ostalo

Pribor za mješanje

# Krunaste testere

Model	Prečnik Ø (mm)	Dubina bušenja (mm)	Broj obrtaja za metal (min <sup>-1</sup> )	Broj obrtaja za nerđajuće čelike (min <sup>-1</sup> )	Broj obrtaja za aluminijum (min <sup>-1</sup> )	Broj obrtaja za drvo (min <sup>-1</sup> )	RPM - plastika (min <sup>-1</sup> )	Cena sa PDV-om
E-04058	140	44	60	25	85	800	800	
E-04064	152	44	55	25	75	800	800	

## Ezychange pribor za kružne testere

	Model	Naziv	Prečnik Ø (mm)	Radna dužina (mm)	Ukupna dužina (mm)	Šestougaoni prihvat (")	Pogodno za	Cena sa PDV-om
	E-04070	Ezychange adapter za HSS-G burgiju za centriranje	7,15	43	85	3/8	limovi i nerđajući čelik, obojeni metal, aluminijum	
	E-04086	HSS-G burgija za centriranje za kružne testere 7,15x85mm	7,15	43	85	1/4	limovi i nerđajući čelik, obojeni metal, aluminijum	
	E-04092	HSS-CO burgija za centriranje za kružne testere 7,15x85mm	7,15	43	85	1/4	nerđajući čelik	

## Ezychange krunaste testere TCT



### Ezychange krunaste testere TCT







Ezychange T.C.T. krune izuzetne izdržljivosti pogodne za rad sa različitim materijalima. T.C.T. legura otporna na toplotu integrisana je na vrhovima zubaca.



Model	Prečnik Ø (mm)	Dubina bušenja (mm)	Broj obrtaja za metal (min <sup>-1</sup> )	Broj obrtaja za nerđajuće čelike (min <sup>-1</sup> )	Broj obrtaja za drvo (min <sup>-1</sup> )	RPM - plastika (min <sup>-1</sup> )	RPM - pločice (min <sup>-1</sup> )	RPM - zidovi (min <sup>-1</sup> )	Cena sa PDV-om
E-06644	20	60	880	440	3.000	3.000	440	880	
E-06650	22	60	780	390	3.000	3.000	390	780	
E-06666	25	60	700	350	2.700	2.700	350	700	
E-06672	32	60	550	280	2.400	2.400	280	550	
E-06688	35	60	500	250	2.400	2.400	250	500	
E-06694	38	60	460	230	2.400	2.400	230	460	
E-06703	40	60	440	220	2.100	2.100	220	440	
E-06719	44	60	390	190	2.100	2.100	190	390	
E-06725	51	60	340	170	2.000	2.000	170	340	
E-06731	54	60	320	160	2.000	2.000	160	320	
E-06747	60	60	280	140	2.000	2.000	140	280	
E-06753	64	60	270	130	1.850	1.850	130	270	
E-06769	67	60	260	130	1.800	1.800	130	260	
E-06775	68	60	260	130	1.800	1.800	130	260	
E-06781	70	60	250	120	1.800	1.800	120	250	
E-06797	73	60	240	120	1.800	1.800	120	240	
E-06806	76	60	230	110	1.800	1.800	110	230	
E-06812	83	60	210	100	1.500	1.500	100	210	
E-06828	102	60	170	80	1.000	1.000	80	170	
E-06834	128	60	130	60	800	800	60	130	

# Krunaste testere

## Pribor za Ezychange krunaste testere TCT

Model	Naziv	Prečnik Ø (mm)	Radna dužina (mm)	Ukupna dužina (mm)	Šestougaoni prihvati (")	Pogodno za	Cena sa PDV-om	
E-06840	HSS-G adapter (105mm)	6,35	62	105	1/4	metal		
E-06856	HSS-Co burgija za centriranje (105mm)	6,35	62	105	1/4	metal		
E-06862	TCT burgija za centriranje (105mm)	6,35	50	105	1/4			
E-06878	Ezychange produžna šipka (150mm)	11	/	150	7/16	/		
E-06884	Ezychange produžna šipka (300mm)	11	/	300	7/16	/		
E-06959	HSS-G adapter 3/8+TCT burgija za centriranje (105mm)	8,7	50	105	3/8			

## HSS-Bi-metalne krunaste testere

### HSS-Bi-metalne krunaste testere

Opseg HSS-Bi-metalnih testera za otvore ima zupce sa promenljivim korakom i preporučuje se za sečenje u čeliku, aluminijumu, bakru, mesingu, drvetu i plastici. Takođe su dostupni u vodoinstalaterskim i električarskim kompletima u najpopularnijim veličinama. Dostupan je šestougaoni nasad, (3 stezna pakna) i SDS-Plus drške.



Model	Prečnik Ø (mm)	Broj obrtaja za čelike (min <sup>-1</sup> )	Broj obrtaja za metal (min <sup>-1</sup> )	Broj obrtaja za aluminijum (min <sup>-1</sup> )	Broj obrtaja za drvo (min <sup>-1</sup> )	Cena sa PDV-om
D-16994	16	275	550	825	3.000	
D-17005	19	230	460	690	3.000	
D-17251	20	220	440	675	3.000	
D-17011	22	195	390	580	3.000	
D-17027	24	185	370	555	3.000	
D-17033	25	175	350	525	2.700	
D-17267	29	150	300	450	2.700	
D-17049	32	140	275	410	2.400	
D-17055	35	125	250	375	2.400	
D-17061	38	115	230	345	2.400	
D-17273	40	110	220	330	2.100	
D-17077	44	95	195	295	2.100	
D-17083	51	85	170	255	2.000	
D-24876	54	80	160	240	2.000	
D-17099	57	75	150	225	2.000	
D-25688	60	70	140	220	2.000	
D-24882	65	65	130	200	1.850	
D-17108	68	65	130	190	1.800	
D-25694	70	60	125	185	1.800	
D-17114	76	55	115	170	1.800	
D-33869	80	55	110	165	1.500	
D-17120	83	50	105	155	1.500	
D-17136	92	45	90	140	1.200	
D-17142	105	40	80	120	1.000	
D-17158	127	30	65	90	800	





Nastavak...

- Akumulat orni i punjači
- Pribor za akumulat orske alate
- Akumulat orske lampe i pribor
- Pribor za laserske merace
- Pribor za rušenje i udarno bušenje
- Pribor za bušenje
- Krunaste testere
- Pribor za pritezanje
- Pribor za sečenje i brušenje
- Pribor za brušenje i poliranje
- Pribor za profilisanje i poravnavanje
- Pribor za višenamenski alat
- Pribor za testere
- Pribor za pneumat ske alate
- Pribor za fenove za vrući vazduh
- Pribor za usisivanje
- Pribor za rad na otvoreno
- Pribor za držače alata i zaštitna
- Koferi i torbe
- Ručni alati
- Ostalo
- Pribor za mješanje

# Krunaste testere

Model	Prečnik Ø (mm)	Broj obrtaja za čelike (min <sup>-1</sup> )	Broj obrtaja za metal (min <sup>-1</sup> )	Broj obrtaja za aluminijum (min <sup>-1</sup> )	Broj obrtaja za drvo (min <sup>-1</sup> )	Cena sa PDV-om
D-17164	152	25	55	75	800	

## Pribor za HSS-Bi-metalne krunaste testere

	Model	Naziv	Cena sa PDV-om
	D-17170	Adapter 16-29	
	D-17186	Adapter 32-152	
	D-17192	Centrirna burgija L=71 mm	
	D-17603	Adapter SDS Plus 14-29	
	D-17619	Adapter SDS Plus 32-152	

## Kompleti HSS-Bi-metalnih krunastih testera

Opseg HSS-Bi-metalnih testera za otvore ima zupce sa promenljivim korakom i preporučuje se za sečenje u čeliku, aluminijumu, bakru, mesingu, drvetu i plastici. Takođe su dostupni u vodoinstalaterskim i električarskim kompletima u najpopularnijim veličinama. Dostupan je šestougaoni nasad, (3 stezna pakna) i SDS-Plus drške.



	Model	Naziv	Dimenzije kruna u kompletu (mm)	Cena sa PDV-om
	D-33641	HSS-Bim komplet krunastih testera, 4 kom.	22, 25, 29, 32	
	D-33641-14	HSS-Bim komplet krunastih testera, 4 kom. (14/1)	22, 25, 29, 32	
	D-33657	HSS-Bim komplet krunastih testera, 6 kom.	22, 29, 32, 51	
	D-33657-10	HSS-Bim komplet krunastih testera, 6 kom. (10/1)	22, 29, 32, 51	
	D-47117	HSS-BIM komplet krunastih testera za vodoinstalatere, 6 kom	19, 22, 29, 38, 44, 57	
	D-47123	HSS-BiM komplet krunastih testera za električare, 6 kom	16, 20, 25, 32, 40, 51	
	D-47139	HSS-BiM komplet krunastih testera za električare, 6 kom	20, 25, 32, 40, 51, 65	

[Nastavak...](#)

# Krunaste testere

Model	Naziv	Dimenzije kruna u kompletu (mm)	Cena sa PDV-om
D-63965	9-delni set BiM kružnih testera za vodoinstalater	19, 22, 29, 38, 44, 57	
D-63971	14-delni set BiM kružnih testera za vodoinstalater	19, 22, 25, 29, 35, 38, 44, 51, 57, 68, 75	
D-63987	12-delni set BiM kružnih testera za Električare	19, 22, 29, 35, 38, 51, 54, 57, 68	
D-63993	16-delni set BiM kružnih testera univerzalni	16, 19, 22, 25, 32, 35, 37, 44, 51, 57, 64, 68, 76	



## HSS-Bi-metalne-Co (8%) krunaste testere



### HSS-Bi-metalne-Co (8%) krunaste testere



Model	Prečnik Ø (mm)	Dubina bušenja (mm)	Broj obrtaja za čelike (min <sup>-1</sup> )	Broj obrtaja za metal (min <sup>-1</sup> )	Broj obrtaja za obojene metale (min <sup>-1</sup> )	Cena sa PDV-om
B-29670	16	20	275	550	825	
B-29686	17	20	250	500	750	
B-29692	19	20	230	460	690	
B-29701	20	20	220	440	675	
B-29717	21	20	210	425	660	
B-29723	22	20	195	390	580	
B-29739	25	20	175	350	252	
B-29745	27	20	160	325	480	
B-29751	29	20	150	300	450	
B-29767	30	20	145	285	425	
B-29773	32	20	140	275	410	
B-29789	33	20	135	260	390	
B-29795	35	20	125	250	375	
B-29804	38	20	115	230	345	
B-29810	40	20	110	220	330	
B-29826	41	20	105	210	315	
B-29832	44	20	95	195	295	
B-29848	48	20	90	180	270	
B-29854	51	20	85	170	255	
B-29860	54	20	80	160	240	
B-29876	57	20	75	150	225	



[Nastavak...](#)

- Akumulat orni i punjači
- Pribor za akumulat orske alate
- Akumulat orske lampe i pribor
- Pribor za laserske merace
- Pribor za rušenje i udarno bušenje
- Pribor za bušenje
- Krunaste testere
- Pribor za pritezanje
- Pribor za sečenje i brusenje
- Pribor za brusenje i poliranje
- Pribor za profilisanje i poravnavanje
- Pribor za višenamenski alat
- Pribor za testere
- Pribor za pneumat ske alate
- Pribor za fenove za vrući vazduh
- Pribor za usisivanje
- Pribor za alate za rad na otvoreno
- Pribor za držače alata i zaštitna
- Koferi i torbe
- Ručni alati
- Ostalo
- Pribor za mješanje

# Krunaste testere



Model	Prečnik Ø (mm)	Dubina bušenja (mm)	Broj obrtaja za čelike (min <sup>-1</sup> )	Broj obrtaja za metal (min <sup>-1</sup> )	Broj obrtaja za obojene metale (min <sup>-1</sup> )	Cena sa PDV-om
B-29882	60	20	70	140	220	
B-29898	64	20	65	135	205	
B-35994	65	20	65	130	200	
B-36005	67	20	65	130	195	
B-36011	68	20	65	130	190	
B-36027	70	20	60	125	185	
B-36033	73	20	60	120	180	
B-36049	76	20	55	115	170	
B-36055	79	20	55	110	165	
B-36061	83	20	50	105	155	
B-36077	86	20	50	100	150	
B-36083	89	20	45	95	145	
B-36099	102	20	40	85	130	
B-36108	127	20	30	65	90	
B-36114	152	20	25	55	75	

## Pribor za HSS-Bi-metalne-Co (8%) krunaste testere

	Model	Naziv	Cena sa PDV-om
	B-36120	Adapter 16-35	
	B-36136	Adapter 38-152	
	B-36142	Centralna burgija L=60 mm	

## Kompleti Bi-Metal-Co (8%) krunastih testera



	Model	Naziv	Burgije u kompletu	Cena sa PDV-om
	B-38663	10-delova HSS-BiM komplet krunastih testera za vodoinstalatore	Kruna: 19, 22, 29, 38, 44, 57 mm, 10 mm nosač krune sa vodicom 16-35 mm, 13 mm nosač krune sa vodicom 38-152 mm, opruga za izbacivanje materijala	
	B-38679	10-delova HSS-BiM komplet krunastih testera za električare	Kruna: 20, 25, 32, 38, 51, 64 mm, 10 mm nosač krune sa vodicom 16-35 mm-13 mm, nosač krune sa vodicom 38-152 mm, opruga za izbacivanje materijala	



## Višenamenske TCT krunaste testere

### Višenamenske TCT krunaste testere

PREPORUKA ZA UPOTREBU: bušiti pod uglom od 90°



Model	Prečnik Ø (mm)	Dubina bušenja (mm)	Broj obrtaja za drvo (min <sup>-1</sup> )	RPM - plastika (min <sup>-1</sup> )	RPM - pločice (min <sup>-1</sup> )	RPM - zidovi (min <sup>-1</sup> )	Cena sa PDV-om
D-42678	19	50	1.000	800	500	800	
D-42684	22	60	1.000	800	500	800	
D-42690	25	60	1.000	800	500	800	
D-42709	29	60	1.000	800	500	800	
D-42715	30	60	1.000	800	500	800	
D-42721	32	60	1.000	800	500	800	
D-42737	35	60	1.000	800	500	800	
D-42743	38	60	800	600	400	700	
D-42759	40	60	800	600	400	700	
D-42765	45	60	800	600	400	700	
D-42771	48	60	800	600	400	700	
D-42787	50	60	800	600	400	700	
D-42793	51	60	800	600	400	700	
D-42802	54	60	600	400	400	600	
D-42818	55	60	600	400	400	600	
D-42824	57	60	600	400	400	600	
D-61488	59	60	600	400	400	600	
D-42830	60	60	600	400	400	600	
D-42846	64	60	600	400	400	600	
D-42852	65	60	600	400	400	600	
D-42868	67	60	600	400	400	600	
D-42874	68	60	600	400	400	600	
D-42880	70	60	600	400	400	600	
D-45026	73	60	600	400	400	600	
D-45032	76	60	400	300	300	300	
D-45048	79	60	400	300	300	300	
D-45331	80	60	400	300	300	300	
D-45347	83	60	400	300	300	300	
D-45353	85	60	400	300	300	300	
D-45369	89	60	400	300	300	300	
D-50304	95	60	400	300	300	300	
D-50310	102	60	400	300	300	300	
D-50326	105	60	400	300	300	300	

Akumulatori i punjači

Pribor za akumulatorske alate

Akumulatorne lampe i pribor

Pribor za laserske merace

Pribor za rušenje i udarno bušenje

Pribor za bušenje

**Krunaste testere**

Pribor za pritezanje

Pribor za sečenje i brušenje

Pribor za brušenje i poliranje

Pribor za profilisanje i poravnavanje

Pribor za višenamenski alat

Pribor za testere

Pribor za pneumatske alate

Pribor za fenove za vrući vazduh

Pribor za usisivanje

Pribor za alate za rad na otvoreno

Pribor za držače alata i zaštitna

Koferi i torbe

Ručni alati

Ostalo

Pribor za mješanje

# Krunaste testere

## Pribor za TCT višenamenske krunaste testere



Model	Naziv	Cena sa PDV-om
D-50332	Hex adapter 13mm sa pilot burgijom 10x100mm T.C.T 22-105mm	
D-50348	SDS-Plus adapter sa pilot burgijom 8x100mm T.C.T 22-32mm	
D-50354	Hex adapter 11mm sa pilot burgijom 8x100mm T.C.T 19mm	
D-50360	SDS-Plus adapter sa pilot burgijom 8x100mm T.C.T 19mm	
D-50376	Hex adapter 11mm sa pilot burgijom 8x100mm H.S.S 22-105mm	
D-50382	SDS-Plus adapter sa pilot burgijom 8x100mm H.S.S 22-32mm	
D-50398	Hex adapter 11mm sa pilot burgijom 6,35x90mm H.S.S 19mm	
D-50407	SDS-Plus adapter sa pilot burgijom 6,35x90mm H.S.S 19mm	
D-50413	Centralna burgija 8x100mm H.S.S	
D-50429	Centralna burgija 10x100mm T.C.T	
D-50435	Centralna burgija 6,35x90mm H.S.S	
D-50441	Centralna burgija 8x90mm T.C.T	

## Dijamantske krune za mokro bušenje tvrde keramike



## Dijamantske krune za mokro bušenje tvrde keramike

Dijamantska prevlaka zuba.



Model	Prečnik Ø (mm)	Prihvata (mm)	Cena sa PDV-om
D-61210	19	10-13	
D-61226	20	10-13	
D-61232	22	10-13	
D-61248	25	10-13	
D-61254	29	13	
D-61260	32	13	
D-61276	35	13	
D-61282	38	13	
D-61298	41	13	
D-61307	44	13	
D-61313	51	13	
D-61329	54	13	
D-61335	57	13	
D-61341	60	13	
D-61357	64	13	
D-61363	65	13	
D-61379	67	13	
D-61385	68	13	
D-61391	70	13	
D-61400	76	13	
D-61416	79	13	
D-61422	83	13	

# Krunaste testere

## Pribor za dijamantske krunice za mokro bušenje tvrde keramike

Model	Naziv	Cena sa PDV-om	
D-61438	Adapter 9,5 mm šestougaoni (za krunice od 19 – 29 mm)		
D-61444	Adapter 11 mm šestougaoni (za krunice od 32 – 83 mm)		
D-61450	Centralni uvlačivi bit za početno bušenje (prečnik: 6 mm, dužina: 74 mm)		

## Krunice testere od volfram karbida za meke materijale

### Krunice testere od volfram karbida

PREPORUKA ZA UPOTREBU: bušiti pod uglom od 90°. Koristiti adapter sa centralnom burgijom. Krunasta testera od volfram karbida je idealna za vodoinstalerske i druge unutrašnje radove, namenjena je isključivo za bušenje u mekim pločicama i mekim ciglama.





Model	Prečnik Ø (mm)	Ukupna dužina (mm)	Najveći broj obrtaja (min <sup>-1</sup> )	Cena sa PDV-om
D-51188	33	54	350	
D-51194	43	57	350	
D-51203	53	57	300	
D-51219	63	57	300	
D-51225	67	57	300	
D-51231	73	57	250	
D-51247	83	57	250	



### Pribor za krunice testere od volfram karbida

Model	Naziv	Ukupna dužina (mm)	Cena sa PDV-om	
D-51253	Adapter 11mm sa centralnom burgijom 90mm, 7/16	90		
D-51269	Centralna burgija 90mm, 9/16	90		

# SETOVI ZA BUŠENJE



Artikal	Broj komada	Dimenzije		
		Beton 	Čelik 	Drvo 
D-05175	5	4, 5, 6, 8, 10 mm		
E-11536	5	4, 5, 6, 8, 10 mm		
D-72877	5	4, 5, 6, 8, 10 mm		
D-73483	12	4, 5, 2x5.5, 2x6, 2x6.5, 2x7, 2x8 mm		
D-30508	5		4, 5, 6, 8, 10 mm	
D-72833	6		2, 3, 4, 5, 6, 8 mm	
D-72849	10		1, 2, 3, 4, 5, 6, 7, 8, 9, 10 mm	
D-72855	13		1.5, 2, 2.5, 3, 3.2, 3.5, 4, 4.5, 4.8, 5, 5.5, 6, 6.5 mm	
P-51873	16		1.5 - 2 komada 2, 2.5, 3, 3.2, 3.5, 4, 4.5, 5, 5.5, 6, 6.5, 7, 8, 10 mm - 1 komad	
D-67527	19		1.5, 2, 2.5, 3, 3.2, 3.5, 4, 4.5, 5, 5.5, 6, 6.5, 7, 8, 10 mm	
D-67549	19		1, 1.5, 2, 2.5, 3, 3.5, 4, 4.5, 5, 5.5, 6, 6.5, 7, 7.5, 8, 8.5, 9, 9.5, 10 mm	
D-67561	19		1, 1.5, 2, 2.5, 3, 3.5, 4, 4.5, 5, 5.5, 6, 6.5, 7, 7.5, 8, 8.5, 9, 9.5, 10 mm	
D-67583	19		1, 1.5, 2, 2.5, 3, 3.5, 4, 4.5, 5, 5.5, 6, 6.5, 7, 7.5, 8, 8.5, 9, 9.5, 10 mm	
P-73673	19		1, 1.5, 2, 2.5, 3, 3.5, 4, 4.5, 5, 5.5, 6, 6.5, 7, 7.5, 8, 8.5, 9, 9.5, 10 mm	
P-60969-25	25		1 - 13 mm (u dimenzijama od po 0.5 mm)	
P-61824-25	25		1 - 13 mm (u dimenzijama od po 0.5 mm)	
D-30564	170		1 - 8 mm (u dimenzijama od po 0.5 mm), 8 - 10 mm (u dimenzijama od po 0.5 mm)	
D-20769	5		5, 6, 8 mm	5, 6 mm
D-72861	5			4, 5, 6, 8, 10 mm
E-08698	8			12, 14, 16, 18, 20, 22, 25, 32 mm
D-23759	5	6 mm	5, 6 mm	5, 6 mm
D-71962	9	5, 6, 8 mm	5, 6, 8 mm	5, 6, 8 mm
D-46202	18	3, 4, 5, 6, 8, 10 mm	3, 4, 5, 6, 8, 10 mm	3, 4, 5, 6, 8, 10 mm
B-44884	21	2x3, 2x4, 5, 6, 8 mm	2x3, 2x4, 5, 6, 8 mm	2x3, 2x4, 5, 6, 8 mm

Artikal	Broj komada							
E-14255	5							

4x75 mm, 5x85 mm, 6x100 mm, 8x120 mm, 10x150 mm

D-05175



E-11536



D-72877



D-73483



D-30508



D-72833



D-72849



D-72855



P-51873

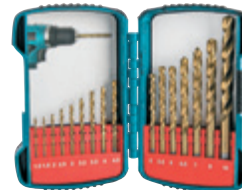

D-67527



D-67549



D-67561



D-67583



P-73673



P-60969-25



P-61824-25



D-30564



D-20769



D-72861



E-08698



D-23759



D-71962



D-46202



B-44884









E-14255



# SETOVI ZA ZAVRTANJE I BUŠENJE



Artikal	Broj komada	Burgije			Kružne testere	Bitovi za zavrtnje	Ključ	Ručni alat
		Beton 	Čelik 	Drvo 				
E-07026	18	✓	✓			✓	✓	
B-54106	38		✓			✓	✓	
D-58877	42		✓			✓	✓	
D-74887	17	✓	✓	✓		✓		
E-07032	27	✓	✓	✓		✓		
E-07054	29	✓	✓	✓		✓		
D-36980	34	✓	✓	✓		✓	✓	
B-68498	34	✓	✓	✓		✓	✓	
E-11829	60	✓	✓	✓		✓		
B-69478	65	✓	✓	✓		✓	✓	✓
196635-4	70	✓	✓	✓		✓	✓	
D-33691	71	✓	✓	✓		✓	✓	✓
E-10730	102	✓	✓	✓	✓	✓		✓
D-31778	104	✓	✓	✓		✓	✓	✓
D-37194	200	✓	✓	✓	✓	✓	✓	✓
E-06270	212	✓	✓	✓	✓	✓	✓	✓
E-11689	256	✓	✓	✓	✓	✓	✓	✓

Artikal	Broj komada	Burgije			Kružne testere	Bitovi za zavrtnje	Ključ	Ručni alat	Broj kompleta u pakovanju
		Beton 	Čelik 	Drvo 					
D-47204	30	✓	✓	✓		✓		1	
D-47204-10								10/1	
D-47145	71	✓	✓	✓		✓	✓	1	
D-47145-6								6/1	
D-47248	100	✓	✓	✓		✓	✓	1	
D-47248-5								5/1	
D-47260	201	✓	✓	✓	✓	✓	✓	1	
D-47260-2								2/1	

E-07026

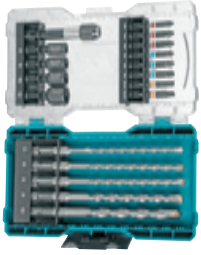

B-54106

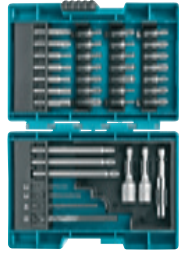

D-58877

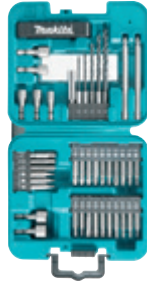

D-74887



E-07032



E-07054



D-36980



B-68498



E-11829



B-69478



196635-4



D-33691



E-10730



D-31778



D-37194



E-06270



E-11689



D-47204

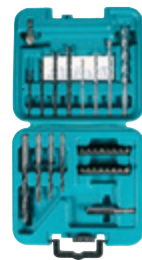

D-47204-10



D-47145



D-47145-6



D-47248



D-47248-5



D-47260



D-47260-2







D-73265



XX7948-901



P-90071



D-73271



P-53746



D-65028

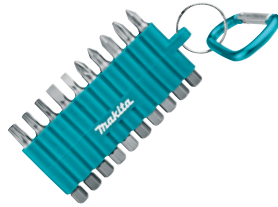

D-64995



P-74740



P-73374



E-10942



P-16782



P-38750



P-70144



E-10899



B-68323



E-07048



E-07060



B-68317



D-65084



E-07076



B-55697



D-73461



B-54081



E-08458



E-11542



E-06616



E-08713



E-10883



D-30651	D-30651-12	D-31083	D-31083-12
---------	------------	---------	------------



B-28896	B-28896-6	B-28911	B-28911-6
---------	-----------	---------	-----------



D-30667	D-30667-12	E-00016	E-00022
---------	------------	---------	---------



D-74762	D-74762-12	B-36170	B-36170-10
---------	------------	---------	------------



# PRIBOR ZA PRITEZANJE

SL ravni umetak



PH umetak



PZ umetak



Torx umetak



Kvadratni umetak



Šestougaoni umetak



Za kvadratni prihvat 3/8"



Za kvadratni prihvat 3/4"



Za kvadratni prihvat 1/2"



Za kvadratni prihvat 1"



1/4" šestougaoni prihvat



Sa magnetom



Izrađeno od hrom-molibdena



**Impact**

# PREMIER

**DUPLA-TORZIJA**  
ZA VISOKU IZDRŽLJIVOST

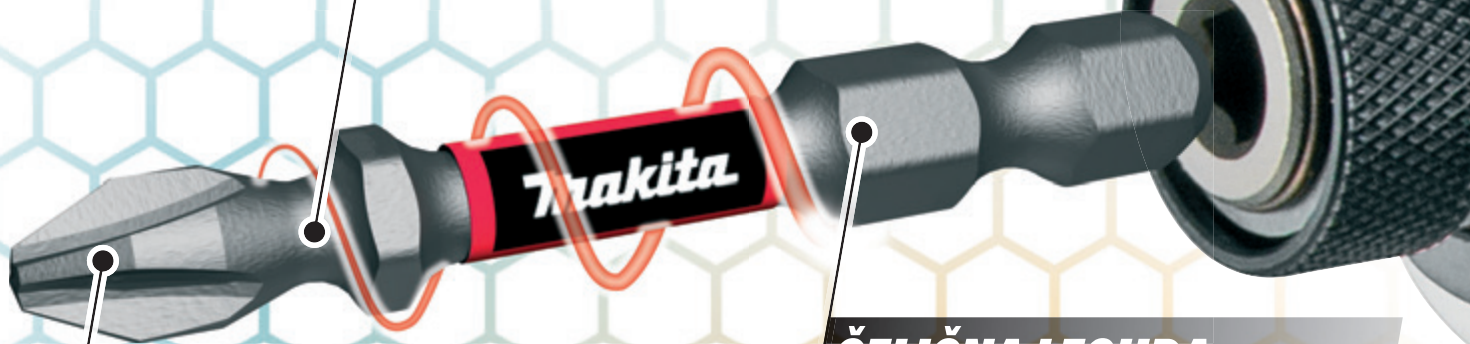

**ČELIČNA LEGURA**  
STVORENA ZA VELIKI OBRтни MOMENT

**VRLO PRECIZAN**  
ODLIČNO NALEŽE NA GLAVU VIJKA

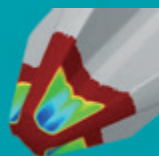
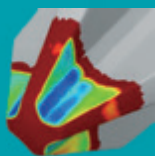

grafički prikaz naleganja



Impact  
**PREMIER**

**STANDARDNI**

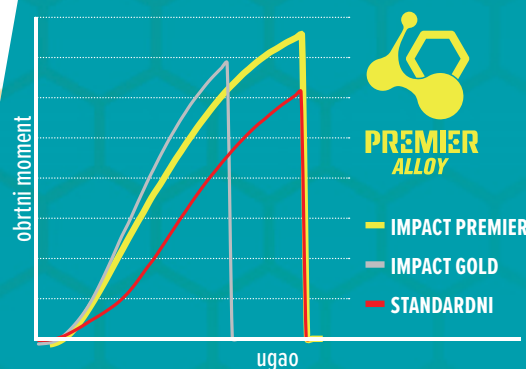

## **NOVA SERIJA**

**BITOVI / DRŽAČI / ADAPTERI ZA ZAVRTNJE**

## Impact Premier umeci i adapteri



### Impact Premier umeci za vijke 25mm

Impact  
**PREMIER**

Model	Ukupna dužina (mm)	Tip vijka	Tip	Prihvat	Jedinica (kom/kompl)	Cena sa PDV-om
E-03121	25	PH1	torzioni	1/4"	2/1	
E-03143	25	PH2	"Super slim" torsion	1/4"	2/1	
E-03246	25	PH2	torzioni	1/4"	15/1	
E-03137	25	PH2	torzioni	1/4"	2/1	
E-03159	25	PH3	torzioni	1/4"	2/1	
E-03165	25	PZ1	torzioni	1/4"	2/1	
E-03252	25	PZ2	torzioni	1/4"	15/1	
E-03171	25	PZ2	torzioni	1/4"	2/1	
E-03187	25	PZ3	torzioni	1/4"	2/1	
E-03193	25	T10	torzioni	1/4"	2/1	
E-03202	25	T15	torzioni	1/4"	2/1	
E-03218	25	T20	torzioni	1/4"	2/1	
E-03224	25	T25	torzioni	1/4"	2/1	
E-03230	25	T30	torzioni	1/4"	2/1	



### Impact Premier umeci za vijke 50mm



Impact  
**PREMIER**

Model	Ukupna dužina (mm)	Tip vijka	Tip	Prihvat	Jedinica (kom/kompl)	Cena sa PDV-om
E-03268	50	PH1	dvostruko torzioni magnetni	1/4"	2/1	
E-03377	50	PH2	dvostruko torzioni magnetni	1/4"	10/1	
E-03274	50	PH2	dvostruko torzioni magnetni	1/4"	2/1	
E-03280	50	PH3	dvostruko torzioni magnetni	1/4"	2/1	
E-03296	50	PZ1	dvostruko torzioni magnetni	1/4"	2/1	
E-03383	50	PZ2	dvostruko torzioni magnetni	1/4"	10/1	
E-03305	50	PZ2	dvostruko torzioni magnetni	1/4"	2/1	
E-03311	50	PZ3	dvostruko torzioni magnetni	1/4"	2/1	
E-03327	50	T10	dvostruko torzioni magnetni	1/4"	2/1	
E-03333	50	T15	dvostruko torzioni magnetni	1/4"	2/1	
E-03349	50	T20	dvostruko torzioni magnetni	1/4"	2/1	
E-03355	50	T25	dvostruko torzioni magnetni	1/4"	2/1	
E-03361	50	T30	dvostruko torzioni magnetni	1/4"	2/1	

Nastavak...

Akumulatori i punjači

Pribor za akumulatorske alate

Akumulatorske lampe i pribor

Pribor za laserske merace

Pribor za rušenje i udarno bušenje

Pribor za bušenje

Krunaste testere

Pribor za pritezanje

Pribor za sečenje i brusenje

Pribor za brusenje i poliranje

Pribor za profilisanje i poravnavanje

Pribor za višenamenski alat

Pribor za testere

Pribor za pneumatske alate

Pribor za fenove za vrući vazduh

Pribor za usisivanje

Pribor za alate za rad na otvoreno

Pribor za držače alata i zaštitna

Koferi i torbe

Ručni alati

Ostalo

Pribor za mješanje

# Pribor za pritezanje

Model	Ukupna dužina (mm)	Tip vijka	Tip	Prihvat	Jedinica (kom/kompl)	Cena sa PDV-om
E-12027	50	T40	dvostruko torzioni magnetni	1/4"	2/1	

## Impact Premier torsion dvostrani umeci











Impact  
**PREMIER**

Model	Ukupna dužina (mm)	Tip vijka	Tip	Prihvat	Jedinica (kom/kompl)	Cena sa PDV-om
E-06286	65	PH2-PH2	dvostruko torzioni magnetni	1/4"	2/1	
E-06292	65	PZ2-PZ2	dvostruko torzioni magnetni	1/4"	2/1	

## Impact Premier nasadni umeci



Impact  
**PREMIER**

	Model	Naziv	Ukupna dužina (mm)	Veličina nasada	Tip	Prihvat	Cena sa PDV-om
	E-03458	Torzioni udarni nasadni umetak Impact Premier H6x65mm	65	6 mm	magnetni	1/4"	
	E-03464	Torzioni udarni nasadni umetak Impact Premier H8x65mm	65	8 mm	magnetni	1/4"	
	E-03470	Torzioni udarni nasadni umetak Impact Premier H10x65mm	65	10 mm	magnetni	1/4"	
	E-03486	Torzioni udarni nasadni umetak Impact Premier H13x65mm	65	13 mm	magnetni	1/4"	
	E-03492	Držać za nasadni ključ udarni Impact Premier H13x80mm	80	13 mm	magnetni	1/4"	
	E-03501	Držać za nasadni ključ udarni Impact Premier H15x80mm	80	15 mm	magnetni	1/4"	
	E-03517	Držać za nasadni ključ udarni Impact Premier H17x80mm	80	17 mm	magnetni	1/4"	
	E-03523	Držać za nasadni ključ udarni Impact Premier H19x80mm	80	19 mm	magnetni	1/4"	
	E-03539	Držać za nasadni ključ udarni Impact Premier H21x80mm	80	21 mm	magnetni	1/4"	



## Impact Premier adapteri, držači

**Impact  
PREMIER**

Model	Naziv	Ukupna dužina (mm)	Veličina nasada (mm)	Tip	Prihvati	Cena sa PDV-om	
E-03442	Magnetni držač sa pojačivačem magnetna udarni Impact Premier	/	/	magnetni	/		
E-03420	Držač za nasadni ključ udarni Impact Premier 3/8 SQ	50	SQ 3/8"	obični	1/4"		
E-03436	Držač za nasadni ključ udarni Impact Premier 1/2 SQ	50	SQ 1/2"	obični	1/4"		
E-03399	Torzioni udarni Impact Premier držač umetaka 68mm	68	/	magnetni	1/4"		
E-03414	Ultramagnetni torzioni udarni Impact Premier držač umetaka	79	/	magnetni	1/4"		
E-03408	Torzioni udarni Impact Premier držač umetaka 150mm	150	/	magnetni	1/4"		



## Impact Premier kompleti

**Impact  
PREMIER**

Model	Naziv	Umetci	Cena sa PDV-om	
E-03567	Impact Premier udarni set 11 kom	25 mm: PH1, PH2, PH3, PZ1, PZ2, PZ3, T15, T20, T25, T30; držač umetka 50 mm		
E-03573	Impact Premier udarni set 11 kom, magnet	25 mm: PH2, PZ1, 2xPZ2, PZ3, T20, T25, T30, SL4, SL6; držač umetka 50 mm		

Akumulatori i punjači

Pribor za akumulatorske alate

Akumulatorske lampe i pribor

Pribor za laserske merace

Pribor za rušenje i udarno bušenje

Pribor za bušenje

Krunaste testere

Pribor za pritezanje

Pribor za sečenje i brušenje

Pribor za brušenje i poliranje

Pribor za profilisanje i poravnavanje

Pribor za višenamenski alat

Pribor za testere

Pribor za pneumatske alate

Pribor za fenove za vrući vazduh

Pribor za usisavanje

Pribor za alate za rad na otvoreno

Pribor za držače alata i zaštitna

Koferi i torbe

Ručni alati

Ostalo

Pribor za mješanje

# IMPACT BLACK

NOVA SERIJA BITEVA / DRŽAČA BITEVA / ADAPTERA



Ojačani  
čelik za dug  
životni vek



Termički  
obrađena  
radi veće  
izdržljivosti



Precizni vrh  
sprečava  
da vijak ne  
ispadne

## NASTAVCI ZA PRITEZANJE

### Torsion umeci

25 mm ne magnetni umeci za vijke.



Ph Pz T



### Magnetni držač umetaka

60 mm



### Torsion magnetni umeci

50 mm magnetni umeci za vijke.



Ph Pz T



### Brzi držač umetaka

60 mm



### Magnetni nasadni ključevi

50 mm | 6,8, 10, 13 mm



### Držač umetaka sa vodilicom za zavrtnanje

80 mm



### Adapteri za nasadne ključeve

50 mm 3/8" | 50 mm 1/2"



## KOMPLETI

# IMPACT BLACK





## Impact Black



### Torzioni umeci

Veliki izbor udarnih bitova 25/50 mm, koji su trajniji od konvencionalnih bitova zbog posebnog procesa kaljenja.

**IMPACT BLACK**  
Impact driver's accessory series

Model	Ukupna dužina (mm)	Tip vijka	Tip	Jedinica (kom/kompl)	Cena sa PDV-om
B-63600	25	PH1	torzioni	2/1	
B-63719	50	PH1	torzioni magnetni	2/1	
E-12407	50	PH2	torzioni	10/1	
B-63616	25	PH2	torzioni	2/1	
B-63725	50	PH2	torzioni magnetni	2/1	
E-12360	25	PH2	torzioni	25/1	
B-63622	25	PH3	torzioni	2/1	
B-63731	50	PH3	torzioni magnetni	2/1	
B-63638	25	PZ1	torzioni	2/1	
B-63747	50	PZ1	torzioni magnetni	2/1	
E-12413	50	PZ2	torzioni	10/1	
B-63644	25	PZ2	torzioni	2/1	
B-63753	50	PZ2	torzioni magnetni	2/1	
E-12376	25	PZ2	torzioni	25/1	
B-63650	25	PZ3	torzioni	2/1	
B-63769	50	PZ3	torzioni magnetni	2/1	
B-63666	25	T15	torzioni	2/1	
B-63775	50	T15	torzioni magnetni	2/1	
E-12429	50	T20	torzioni	10/1	
B-63672	25	T20	torzioni	2/1	
B-63781	50	T20	torzioni magnetni	2/1	
E-12382	25	T20	torzioni	25/1	
E-12435	50	T25	torzioni	10/1	
B-63688	25	T25	torzioni	2/1	
B-63797	50	T25	torzioni magnetni	2/1	
E-12398	25	T25	torzioni	25/1	
E-12675	50	T30	torzioni	10/1	
B-63694	25	T30	torzioni	2/1	
B-63806	50	T30	torzioni magnetni	2/1	
E-12653	25	T30	torzioni	25/1	
E-12681	50	T40	torzioni	10/1	
B-63703	25	T40	torzioni	2/1	
B-63812	50	T40	torzioni magnetni	2/1	
E-12669	25	T40	torzioni	25/1	

Akumulat  
ori i  
punjači

Pribor za  
akumulat  
orske  
alate

Akumulat  
orske  
lampe i  
pribor

Pribor za  
laserske  
merace

Pribor za  
rušenje i  
udarno  
bušenje

Pribor za  
bušenje

Krunaste  
testere

Pribor za  
pritezanje  
e

Pribor za  
sečenje i  
brusenje

Pribor za  
brusenje  
i  
poliranje

Pribor za  
profilisanje  
e i  
poravnavanje

Pribor za  
višenam  
enski alat

Pribor za  
testere

Pribor za  
pneumat  
ske alate

Pribor za  
fenove  
za vrući  
vazduh

Pribor za  
usisivanje

Pribor za  
alate za  
rad na  
otvoreno

Pribor za  
držače  
alata i  
zaštitna

Koferi i  
torbe

Ručni  
alati





Ostalo

Pribor za  
mješanje







## Impact Black držači

**IMPACT BLACK**  
 Impact driver's accessory series

	Model	Naziv	Ukupna dužina (mm)	Prihvat	Cena sa PDV-om
	B-66793	Impact BLACK magnetni držač	60	1/4"	
	B-66802	Impact BLACK brzi držač bita	60	1/4"	
	B-66818	Impact BLACK držač bita sa vodilicom za zavrtnje	80	1/4"	
	B-66868	Impact Black adapter za nasadne ključeve 3/8"	50	1/4"	
	B-66874	Impact BLACK adapter za nasadne ključeve 1/2"	50	1/4"	

## Impact Black magnetni nasadni umeci

**IMPACT BLACK**  
 Impact driver's accessory series

	Model	Naziv	Ukupna dužina (mm)	Veličina nasada	Prihvat	Tip vijka	Tip	Cena sa PDV-om
	B-66824	Impact BLACK magnetni nasadni umeci	50	6 mm	1/4"	M3,5	magnetni	
	B-66830	Impact BLACK magnetni nasadni umeci	50	8 mm	1/4"	M5	magnetni	
	B-66846	Impact BLACK magnetni nasadni umeci	50	10 mm	1/4"	M6	magnetni	
	B-66852	Impact BLACK magnetni nasadni umeci	50	13 mm	1/4"	M8	magnetni	



**IMPACT BLACK**  
Impact driver's accessory series

## Kompleti

Model	Naziv	Umetci	Jedinica (kom/kompl)	Cena sa PDV-om	
B-66880	Impact BLACK set 35kom	Umetci za vijke od 25 mm: PH1-PH3, PZ1-PZ3, T15-T30 / Umetci za vijke od 50 mm: PH1-PH3, PZ1-PZ3, T15-T30, SL 0.8x5.5 / Magnetni nasadni ključevi za matice od 6 mm do 13 mm / Magnetni držač umetka	1		
B-66896	Impact BLACK set 33 kom	Umetci za vijke od 25 mm: PH1-PH3, PZ1-PZ3, T15-T30 / Umetci za vijke od 50 mm: PH2, PZ2, T15-T30 / 1/4" HSS spiralne burgije od 2.5 mm do 5 mm / Magnetni nasadni ključevi za matice od 6 mm do 10 mm / Magnetni držač umetka / Držač vodice vijka	1		
E-03084	Impack BLACK set 31kom	25mm: 2xPH1, 5xPH2, 2xPH3, 2xPZ1, 5xPZ2, 2xPZ3, 3xT15, 3xT20, 3xT25, 3xT30, 60 mm magnetni držač	1		
E-03109	Impack BLACK set 90kom	25mm: 5xPH1, 10xPH2, 5xPH3, 5xPZ1, 10xPZ2, 5xPZ3, 6xT15, 6xT20, 6xT25, 6xT30; 50mm: PH1, 4xPH2, 2xPH3, PZ1, 4xPZ2, 2xPZ3, 2xT15, 2xT20, 2xT25, 2xT30, SL0.8x5.5, 60mm magnetno držalo, 50mm priključni magnetni ključ: 6, 8mm	1		
E-11994	Impack BLACK set 8kom	25mm: PH1, 2xPH2, PH3, PZ1, PZ2, PZ3, 60mm magnetni držač umetka	1		
E-12011	Impack BLACK set 10kom	50 mm: PH1, PH2, PH3, PZ1, PZ2, PZ3, T15, T20, T25, T30	1		
E-12441	Impact BLACK set 33kom	PH1, 2xPH2, PH3, PZ1, 2xPZ2, PZ3, T10, T15, 2xT20, T25, T27, T30, T40, T10H, T15H, T20H, T25H, T27H, T30H, T40H, SL0.5x3, SL0.8x4, SL0.8x5, SL1.2x6.5, HEX3, HEX4, HEX5, HEX6, Držač umetka za futer, Adapter 1/4"	1		
E-12441-10	Impact BLACK set 33kom (10/1)	PH1, 2xPH2, PH3, PZ1, 2xPZ2, PZ3, T10, T15, 2xT20, T25, T27, T30, T40, T10H, T15H, T20H, T25H, T27H, T30H, T40H, SL0.5x3, SL0.8x4, SL0.8x5, SL1.2x6.5, HEX3, HEX4, HEX5, HEX6, Držač umetka za futer, Adapter 1/4"	10/1		

- Akumulat orni i punjači
- Pribor za akumulat orske alate
- Akumulat orske lampe i pribor
- Pribor za laserske merace
- Pribor za rušenje i udarno bušenje
- Pribor za bušenje
- Krunaste testere
- Pribor za pritezanje
- Pribor za sečenje i brušenje
- Pribor za brušenje i poliranje
- Pribor za profilisanje i poravnanje
- Pribor za višenam enski alat
- Pribor za testere
- Pribor za pneumat ske alate
- Pribor za fenove za vrući vazduh
- Pribor za usisivanje
- Pribor za alate za rad na otvoreno
- Pribor za držače alata i zaštitna
- Koferi i torbe
- Ručni alati
- Ostalo
- Pribor za mješanje

## Umeci za vijke

## Phillips (PH) umeci

DIN3126



Model	Ukupna dužina (mm)	Tip vijka	Tip	Prihvata	Jedinica (kom/kompl)	Cena sa PDV-om
P-06030	25	PH1	torzioni	1/4"	10/1	
P-06052	25	PH2	torzioni	1/4"	10/1	
P-06074	25	PH3	torzioni	1/4"	10/1	
P-06046	50	PH1	torzioni	1/4"	10/1	
P-06068	50	PH2	torzioni	1/4"	10/1	
P-06080	50	PH3	torzioni	1/4"	10/1	
B-57788	90	PH2	obični	1/4"	1/1	
B-57847	150	PH2	obični	1/4"	1/1	
B-57853	150	PH3	obični	1/4"	1/1	

## Pozidrive (PZ) umeci

DIN3126



Model	Ukupna dužina (mm)	Tip vijka	Tip	Prihvata	Jedinica (kom/kompl)	Cena sa PDV-om
P-06096	25	PZ1	torzioni	1/4"	10/1	
P-06111	25	PZ2	torzioni	1/4"	10/1	
P-06133	25	PZ3	torzioni	1/4"	10/1	
P-06105	50	PZ1	torzioni	1/4"	10/1	
P-06127	50	PZ2	torzioni	1/4"	10/1	
P-06149	50	PZ3	torzioni	1/4"	10/1	
B-59885	90	PZ2	obični	1/4"	1/1	
B-59950	150	PZ2	obični	1/4"	1/1	
B-59966	150	PZ3	obični	1/4"	1/1	

## Torx (T) umeci

DIN3126



Model	Ukupna dužina (mm)	Tip vijka	Tip	Prihvata	Jedinica (kom/kompl)	Cena sa PDV-om
P-06339	25	T15	obični	1/4"	10/1	
P-06345	25	T20	obični	1/4"	10/1	
P-06351	25	T25	obični	1/4"	10/1	
P-06367	25	T27	obični	1/4"	10/1	
P-06373	25	T30	obični	1/4"	10/1	
P-06389	25	T40	obični	1/4"	10/1	

Nastavak...

# Pribor za pritezanje

117

Model	Ukupna dužina (mm)	Tip vijka	Tip	Prihvat	Jedinica (kom/kompl)	Cena sa PDV-om
P-72590	50	T10	obični	1/4"	3/1	
P-72609	50	T15	obični	1/4"	3/1	
P-72615	50	T20	obični	1/4"	3/1	
P-72643	50	T30	obični	1/4"	3/1	
P-72659	50	T40	obični	1/4"	3/1	
B-59900	90	T15	obični	1/4"	1/1	
B-59916	90	T20	obični	1/4"	1/1	
B-59922	90	T25	obični	1/4"	1/1	
B-59938	90	T30	obični	1/4"	1/1	
B-59972	150	T15	obični	1/4"	1/1	
B-59988	150	T20	obični	1/4"	1/1	
B-59994	150	T25	obični	1/4"	1/1	
B-60006	150	T30	obični	1/4"	1/1	

## Square (SQ) umeci za vijke



Model	Ukupna dužina (mm)	Tip vijka	Prihvat	Tip	Cena sa PDV-om
B-57825	90	SQ3	1/4"	magnetni	
B-57869	150	SQ1	1/4"	magnetni	
B-57875	150	SQ2	1/4"	magnetni	
B-57881	150	SQ3	1/4"	magnetni	

## Torsion (PH,PZ) dvostrani umeci

Visoki obrtni moment proizveden od udarnih odvijača oštećuje standardne umetke, ali novi Makita dvostrani umeci za vijke su izvan svih očekivanja, traju do 10 puta duže od standardnih.



Model	Ukupna dužina (mm)	Tip vijka	Tip	Prihvat	Jedinica (kom/kompl)	Cena sa PDV-om
B-20703	65	PH2	torzioni	1/4"	3/1	
B-20719	65	PZ2	torzioni	1/4"	3/1	
B-20725	65	PZ3	torzioni	1/4"	3/1	
B-21870	65	PH3	torzioni	1/4"	3/1	
B-12326	85	PH2	torzioni	1/4"	3/1	
B-12790	85	PZ2	torzioni	1/4"	3/1	
B-16259	85	PZ2	torzioni	1/4"	18/1	
B-20731	85	PZ3	torzioni	1/4"	3/1	
B-21886	85	PH3	torzioni	1/4"	3/1	

Akumulat  
ori i  
punjači

Pribor za  
akumulat  
orske  
alate

Akumulat  
orske  
lampe i  
pribor

Pribor za  
laserske  
merace

Pribor za  
rušenje i  
udarno  
bušenje

Pribor za  
bušenje

Krunaste  
testere

Pribor za  
pritezanje

Pribor za  
sečenje i  
brusjenje

Pribor za  
brusjenje  
i  
poliranje

Pribor za  
profilisanje  
i  
poravnavanje

Pribor za  
višenam  
enski alat

Pribor za  
testere

Pribor za  
pneumat  
ske alate

Pribor za  
fenove  
za vrući  
vazduh

Pribor za  
usisivanje

Pribor za  
alate za  
rad na  
otvoreno

Pribor za  
držače  
alata i  
zaštitna

Koferi i  
torbe















Ručni  
alati

Ostalo

Pribor za  
mješanje

## Adapteri, držači umetaka i BITRO umeci za vijke

## Adapteri, držači umetaka i BITRO umeci za vijke

	Model	Naziv	Ukupna dužina (mm)	Prihvati	Cena sa PDV-om
	B-54411	Hvatač umetaka MZ	/	1/4"	
	D-61690	Bit PH2 sa ograničenjem dubine	30	1/4"	
	D-74740	Adapter za 1/4" nasadne ključeve	50	1/4"	
	784811-8	Magnetni držač umetaka	60	1/4"	
	B-52445	Magnetni držač bita	60	1/4"	
	B-52467	Brzi držač bita	60	1/4"	
	P-05979	Magnetni držač umetka	60	1/4"	
	P-54075	Brzoizmenljivi prihvat umetaka	60	1/4"	
	P-05985	Magnetni držač umetka	75	1/4"	
	B-52934	Držač bita sa vodilicom za zavrtnje, transparentni, 120 m	120	1/4"	
	B-57750	Magnetni držač umetka	150	1/4"	
	B-57738	Adapter za 3/8" nasadne ključeve	152	1/4"	
	B-57744	Adapter za 1/2" nasadne ključeve	152	1/4"	
	B-29072	Fleksibilni držač umetaka	200	1/4"	
	B-29094	Fleksibilni držač umetaka	300	1/4"	
	B-57766	Magnetni držač umetaka	300	1/4"	

## Nasadni umeci



### Nasadni umeci



Model	Ukupna dužina (mm)	Veličina nasada	Tip	Prihvat	Cena sa PDV-om
P-06270	55	5,5	obični	1/4"	
P-06286	55	7	obični	1/4"	
P-06292	55	8	obični	1/4"	
P-06301	55	10	obični	1/4"	
P-06317	55	13	obični	1/4"	
P-38548	55	17	obični	1/4"	



### Magnetni nasadni umeci

Odičan pribor za različite vrste posla. Magnetni nasadni umetak se koristi za rad sa vijcima sa šestostranom glavom, koji se obično koriste za obezbeđivanje plafona, zidova, unutrašnjih materijala itd. Magnet privlači vijak sa šestostranom glavom i sprečava da ispadne tokom radova na visokim mestim i radova sa jednom rukom. Upotreba: Završni enterijeri, završni poslovi na zidovima, limarija.



Model	Ukupna dužina (mm)	Veličina nasada	Prihvat	Jedinica (kom/kompl)	Cena sa PDV-om
B-38685	50	5,5 mm	1/4"	1	
B-38691	50	6 mm	1/4"	1	
B-38700	50	7 mm	1/4"	1	
B-38716	50	8 mm	1/4"	1	
B-38722	50	10 mm	1/4"	1	
B-38738	50	12 mm	1/4"	1	
B-38744	50	13 mm	1/4"	1	
B-38750	50	17 mm	1/4"	1	
B-38766	50	6,35 mm (1/4")	1/4"	1	
B-38772	50	7,9 mm (5/16")	1/4"	1	
B-38788	50	9,6 mm (3/8")	1/4"	1	
B-38906	50	5,5 mm	1/4"	1	
B-38912	50	6 mm	1/4"	1	
B-38934	50	8 mm	1/4"	1	
B-38940	50	10 mm	1/4"	1	
B-38956	50	12 mm	1/4"	1	
B-38962	50	13 mm	1/4"	1	
B-38978	50	17 mm	1/4"	1	
B-39154	50	6, 8, 10, 12, 13 mm	1/4"	5/1	
B-57554	50	8, 10, 12, 13 mm	1/4"	4/1	

 Akumulat  
ori i  
punjači

 Pribor za  
akumulat  
orske  
alate

 Akumulat  
orske  
lampe i  
pribor

 Pribor za  
laserske  
merace

 Pribor za  
rušenje i  
udarno  
bušenje

 Pribor za  
bušenje

 Krunaste  
testere

 Pribor za  
pritezanje

 Pribor za  
sečenje i  
brusjenje

 Pribor za  
brusjenje  
i  
poliranje

 Pribor za  
profilisanje  
i  
poravnava

 Pribor za  
višenam  
enski alat

 Pribor za  
testere

 Pribor za  
pneumat  
ske alate

 Pribor za  
fenove  
za vrući  
vazduh

 Pribor za  
usisivanje

 Pribor za  
alate za  
rad na  
otvoreno

 Pribor za  
držače  
alata i  
zaštitna

 Koferi i  
torbe

 Ručni  
alati

Ostalo

 Pribor za  
mješanje

## Dugi nasadni ključevi

Za učinkovitiji rad sa navojnim šipkama (brezonima) i dugim vijcima.



Model	Ukupna dužina (mm)	Veličina nasada	Prihvat	Cena sa PDV-om
B-52526	75	10	1/4"	
B-52532	150	10	1/4"	
B-52548	300	10	1/4"	
B-52554	500	10	1/4"	
B-52560	700	10	1/4"	
B-52576	75	13	1/4"	
B-52582	150	13	1/4"	
B-52598	300	13	1/4"	
B-52607	500	13	1/4"	
B-52613	700	13	1/4"	
B-52629	75	17	1/4"	
B-52635	150	17	1/4"	
B-52641	300	17	1/4"	
B-52657	500	17	1/4"	
B-52663	700	17	1/4"	

## Bitovi za navojnu šipku

Navojne šipke se često koriste pri montaži klima uređaja, rasvete, cevi i kablova. Bit za navojne šipke znatno smanjuje vrijeme i energiju pri montaži navojnih šipki u odnosu na ručno postavljanje.



Model	Naziv	Dužina (D) (mm)	Tip vijka	Prihvat	Cena sa PDV-om
B-42961	Bit za navojnu šipku	66	M6	1/4"	
B-42977	Bit za navojnu šipku	66	M8	1/4"	
B-42983	Bit za navojnu šipku	66	M10	1/4"	





# Pribor za pritezanje

121

## Kompleti

### Ostali pribor

Model	Naziv	Cena sa PDV-om	
B-69917	Kutija u obliku baterije		
D-58833	Odvijač sa račnom sa PH2 bitom		

## Pribor za odvijače sa magacinom

### Phillips (PH) umeci za odvijače sa magacinom

Odvijači sa automatskim dodavanjem proizvedeni posle serijskih brojeva prikazanim desno, koriste 5 mm umetke, što je jasno obeleženo na kalemu mašine. Modeli pre ovih serijskih brojeva koriste 6 mm umetke.



Model	Ukupna dužina (mm)	Tip vijka	Prečnik Ø (mm)	Prihvata	Za model	Jedinica (kom/kompl)	Cena sa PDV-om
P-66232	117	PH2	5	1/4"	DFR440	10/1	
P-13568	127	PH2	6	1/4"	6832, 6833, 6835DWA	10/1	
P-67795	157	PH2	5	1/4"	6842, DFR550	3/1	
P-67804	177	PH2	5	1/4"	6844, DFR750	3/1	

### Pozidrive (PZ) umeci za odvijače sa magacinom

Odvijači sa automatskim dodavanjem proizvedeni posle serijskih brojeva prikazanim desno, koriste 5 mm umetke, što je jasno obeleženo na kalemu mašine. Modeli pre ovih serijskih brojeva koriste 6 mm umetke.



Model	Ukupna dužina (mm)	Tip vijka	Prečnik Ø (mm)	Prihvata	Za model	Jedinica (kom/kompl)	Cena sa PDV-om
P-66260	117	PZ2	5	1/4"	DFR440	10/1	
P-13580	127	PZ2	6	1/4"	6835DWA	10/1	
P-66276	127	PZ2	5	1/4"	6835DWA	10/1	
P-67773	157	PZ2	5	1/4"	6842, 6843, DFR540	3/1	
P-67789	177	PZ2	5	1/4"	DFR750	3/1	

Akumulat  
ori i  
punjači

Pribor za  
akumulat  
orske  
alate

Akumulat  
orske  
lampe i  
pribor

Pribor za  
laserske  
merace

Pribor za  
rušenje i  
udarno  
bušenje

Pribor za  
bušenje

Krunaste  
testere

Pribor za  
pritezanje

Pribor za  
sečenje i  
brusjenje

Pribor za  
brusjenje  
i  
poliranje

Pribor za  
profilisanje  
i  
poravnava

Pribor za  
višenam  
enski alat

Pribor za  
testere

Pribor za  
pneumat  
ske alate

Pribor za  
fenove  
vazduh

Pribor za  
usisivanje

Pribor za  
alate za  
rad na  
otvoreno

Pribor za  
držače  
alata i  
zaštitna

Koferi i  
torbe

Ručni  
alati

Ostalo

Pribor za  
mješanje



## Umeci za odvijače sa magacinom - PH2

Model	Veličina glave vijka (mm)	Dužina (D) (mm)	Navoj	Završno	Pogodno za	Za model	Jedinica (kom/kompl)	Cena sa PDV-om
F-30913	3,9	25	Fin	fosfatirani	Suva gradnja na metalnim profilima (gips karton na metalnu osnovu)	DFR550	1.000/1	
F-30926	3,9	30	Fin	fosfatirani	Suva gradnja na metalnim profilima (gips karton na metalnu osnovu)	DFR550	1.000/1	
F-30942	3,9	55	Fin	fosfatirani	Suva gradnja na metalnim profilima (gips karton na metalnu osnovu)	DFR550, DRF750	1.000/1	
F-31153	3,9	35	Fin	fosfatirani	šperploče i drvene konstrukcije	DFR550	1.000/1	
F-31179	3,9	35	Grub	fosfatirani	Suva gradnja na drvenoj osnovi (gips karton na drvenu osnovu)	DFR550	1.000/1	
F-31182	3,9	41	Grub	fosfatirani	Suva gradnja na drvenoj osnovi (gips karton na drvenu osnovu)	DFR550	1.000/1	
F-31201	4,2	40	Fin	pocinkovani	Suva gradnja na drvenoj osnovi (gips karton na drvenu osnovu)	DFR550	1.000/1	
P-13225	4,5	75	Grub	fosfatirani	Suva gradnja na drvenoj osnovi (gips karton na drvenu osnovu)	DFR550	500/1	

## Komplet u koferu



Model	Naziv	Dužina vijka (mm)	Za model	Cena sa PDV-om
125537-7	Komplet	25-41	DFR440	
195184-8	Komplet	25-55	6842, 6843, DFR540, DFR550	



## Mehanizam za dodavanje vijka i umeci

Model	Naziv	Dužina vijka (mm)	Tip vijka	Za model	Jedinica (kom/kompl)	Cena sa PDV-om
191L24-0	Nastavak za vijke u redeniku	25-55		DFS452, DFS250, FS6300, FS4300, FS4200, FS4000, FS2300	1	
191V01-2	Umeci PH 137	137	PH2	DFR452	5/1	
191V02-0	Umeci PH 155	155	PH2	DFR551	5/1	

Nastavak...

# Pribor za pritezanje

123

Model	Naziv	Dužina vijka (mm)	Tip vijka	Za model	Jedinica (kom/kompl)	Cena sa PDV-om
191V03-8	Umeci SQ 137	137	SQ2	DFR452	5/1	
191V04-6	Umeci SQ 155	155	SQ2	DFR551	5/1	
191V05-4	Umeci PZ 137	137	PZ2	DFR452	5/1	
191V06-2	Umeci PZ 155	155	PZ2	DFR551	5/1	
191W93-7	Nastavak za vijke u redeniku	20-41		DFR452, DFR551	1	
191W94-5	Nastavak za vijke u redeniku	25-55		DFR452, DFR551	1	
199155-7	Umeci PH2	130	PH2	DFS452, DFS451, DFS250, FS6300, FS6200, FS4300, FS4200, FS4000, FS2300, FS2200	5/1	
199156-5	Umeci SQ2	130	SQ2	DFS452, DFS451, DFS250, FS6300, FS6200, FS4300, FS4200, FS4000, FS2300, FS2200	5/1	

## Produžne drške

Produženje dužine od 600 do 700 mm sa povlačenjem (ukupna dužina, uključujući i mašinu iznosi od 890 do 990 mm).



Model	Za model	Cena sa PDV-om
194500-1	6840, 6841, 6841R, 6842, 6843, 6844, 6845, DFR440, DFR540, DFR550, DFR750	

## Adapteri za odvijače

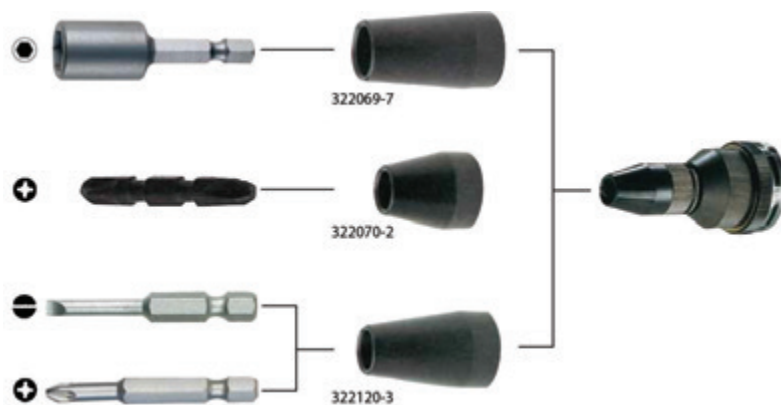

Model	Opis	Za model	Cena sa PDV-om
197024-6	Čaura za centriranje, za 75 mm držač bita	DFS452, DFS451, FS2300, FS4000, FS4300, FS6300R	
197025-4	Čaura za centriranje, za 60 mm držač bita	DFS452, DFS451, FS2300, FS4000, FS4300, FS6300R	
322069-7	Čaura za vođenje za nasadni ključ (Φ 15,5 mm x 45 mm)	6827, FS2700	
322070-2	Čaura za vođenje za 45 mm umetke (Φ 12 mm x 30 mm)	6827, FS2700	
322120-3	Čaura za vođenje za 50 mm umetke (Φ 12 mm x 42 mm)	6805BV, 6827, FS2700	

Akumulat  
ori i  
punjači

Pribor za  
akumulat  
orske  
alate

Akumulat  
orske  
lampe i  
pribor

Pribor za  
laserske  
merace

Pribor za  
rušenje i  
udarno  
bušenje

Pribor za  
bušenje

Krunaste  
testere

Pribor za  
pritezanje

Pribor za  
sečenje i  
brusjenje

Pribor za  
brusjenje  
i  
poliranje

Pribor za  
profilisanje  
i  
poravnavanje

Pribor za  
višenam  
enski alat

Pribor za  
testere

Pribor za  
pneumat  
ske alate

Pribor za  
fenove  
za vrući  
vazduh

Pribor za  
usisivanje

Pribor za  
alate za  
rad na  
otvoreno

Pribor za  
držače  
alata i  
zaštitna

Koferi i  
torbe

Ručni  
alati

Ostalo

Pribor za  
mješanje

## Pribor za udarne odvijače



## Udarni nasadni ključevi Cr-Mo sa O-prstenom 1"

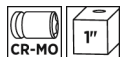

Model	Ukupna dužina (mm)	Veličina nasada	Tip vijka	Prihvat	Cena sa PDV-om
134864-1	80	35	7/8"	1"	
134865-9	80	36	M24	1"	
134872-2	80	41	M27	1"	



## Udarni nasadni ključevi Cr-Mo sa O-prstenom 1/2"

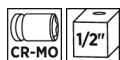

Model	Ukupna dužina (mm)	Veličina nasada	Tip vijka	Prihvat	Cena sa PDV-om
134825-1	38	13	M8	1/2"	
134827-7	52	13	M8	1/2"	
134829-3	38	17	M10	1/2"	
134830-8	52	17	M10	1/2"	
134831-6	38	19	M12	1/2"	
134832-4	52	19	M12	1/2"	
134833-2	52	21	M14	1/2"	
134838-2	38	21	M14	1/2"	
134834-0	52	22	M14	1/2"	
134851-0	38	22	M14	1/2"	
134835-8	52	23	M14	1/2"	
134836-6	52	24	M16	1/2"	
134841-3	45	24	M16	1/2"	
134844-7	50	27	M18	1/2"	
134845-5	78	27	M18	1/2"	
134846-3	50	30	M20	1/2"	
134847-1	78	30	M20	1/2"	
134848-9	50	32	M22	1/2"	
134849-7	78	32	M22	1/2"	



## Udarni nasadni ključevi Cr-Mo sa O-prstenom 3/4"

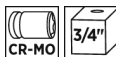

Model	Ukupna dužina (mm)	Veličina nasada	Tip vijka	Prihvati	Cena sa PDV-om
A-85494	50	17	M10	3/4"	
A-85519	50	19	M12	3/4"	
A-85553	52	22	M14	3/4"	
A-85575	52	24	M16	3/4"	
134853-6	52	26	M16	3/4"	
134854-4	95	26	M16	3/4"	
134855-2	52	27	M18	3/4"	
134857-8	52	30	M20	3/4"	
134858-6	95	30	M20	3/4"	
134859-4	95	32	M22	3/4"	
134871-4	52	32	M22	3/4"	
134861-7	95	35	7/8"	3/4"	
134862-5	56	36	M24	3/4"	
134863-3	95	36	M24	3/4"	



## Udarni nasadni ključevi Cr-Mo bez O-prstena 3/8"

Za udarne ključeve sa 3/8" kvadratnim prihvatom. Nasadni ključ je namenjen za električne i pneumatske alate. Nasad prenosi visoki obrtni moment kada se koristi sa električnim alatima. Zbog toga, kao materijal za nasad koristi se „Cr-Mo (hrom molibden čelik)“, koji ima visoku izdržljivost. Naziv materijala „Cr-Mo“ je laserski označen na površini nasada.

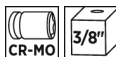

Model	Ukupna dužina (mm)	Veličina nasada	Prihvati	Cena sa PDV-om
B-39883	28	6	3/8"	
B-39899	28	7	3/8"	
B-39908	28	8	3/8"	
B-39914	28	9	3/8"	
B-39920	28	10	3/8"	
B-39936	28	11	3/8"	
B-39942	28	12	3/8"	
B-39958	28	13	3/8"	
B-39964	28	14	3/8"	
B-39970	28	15	3/8"	
B-39986	28	16	3/8"	
B-39992	30	17	3/8"	
B-40004	30	18	3/8"	
B-40010	30	19	3/8"	
B-40026	30	20	3/8"	
B-40032	30	21	3/8"	

[Nastavak...](#)

Akumulat  
ori i  
punjači

Pribor za  
akumulat  
orske  
alate

Akumulat  
orske  
lampe i  
pribor

Pribor za  
laserske  
merace

Pribor za  
rušenje i  
udarno  
bušenje

Pribor za  
bušenje

Krunaste  
testere

Pribor za  
pritezanje

Pribor za  
sečenje i  
brusjenje

Pribor za  
brusjenje  
i  
poliranje

Pribor za  
profilisanje  
i  
poravnava

Pribor za  
višenam  
enski alat

Pribor za  
testere

Pribor za  
pneumat  
ske alate

Pribor za  
fenove  
za vrući  
vazduh

Pribor za  
usisivanje

Pribor za  
alate za  
rad na  
otvoreno

Pribor za  
držače  
alata i  
zaštitna

Koferi i  
torbe

Ručni  
alati

Ostalo

Pribor za  
mješanje

# Pribor za pritezanje

Model	Ukupna dužina (mm)	Veličina nasada	Prihvat	Cena sa PDV-om
B-40048	30	22	3/8"	



## Tip dubokog udarnog umetka od 3/8"

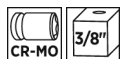

Model	Ukupna dužina (mm)	Veličina nasada	Prihvat	Cena sa PDV-om
B-55398	63	7	3/8"	
B-55407	63	8	3/8"	
B-55413	63	9	3/8"	
B-55429	63	10	3/8"	
B-55435	63	11	3/8"	
B-55441	63	12	3/8"	
B-55457	63	13	3/8"	
B-55463	63	14	3/8"	
B-55479	63	15	3/8"	
B-55485	63	16	3/8"	
B-55491	63	17	3/8"	
B-55500	63	18	3/8"	
B-55516	63	19	3/8"	
B-55522	63	20	3/8"	
B-55538	63	21	3/8"	
B-55544	63	22	3/8"	



## Komplet udarnih nasadnih ključeva





Omogućava stezanje i otpuštanje matica i vijaka

Model	Naziv	Veličina nasada	Prihvat	Cena sa PDV-om
B-54645	9-delni set 1/2" udarnih nasadnih ključeva sa adapterom 1/4"	8, 10, 12, 13, 14, 15, 17, 18 mm	1/2"	
B-55550	14-delni set 3/8" udarnih nasadnih ključeva	63 mm; 8, 9, 10, 11, 12, 13, 14, 15, 16, 17, 18, 19, 21, 22 mm	3/8"	
B-66232	9-delni set 1/2" udarnih nasadnih ključeva	8, 10, 12, 13, 14, 16, 17, 19, 21mm	1/2"	

Nastavak...

# Pribor za pritezanje

127

Model	Naziv	Veličina nasada	Prihvati	Cena sa PDV-om	
B-69733	Set kovanih nastavaka	13, 17, 19, 21, 22, 24 mm	1/2"		
B-69749	Set kovanih nastavaka u platnenoj torbici	10, 11, 13, 17, 19, 21, 22, 24, 27 mm	1/2"		
E-02989	Komplet od 8 udarnih umetaka smeštenih u torbici	8, 10, 12, 13, 14, 17, 19, 21 mm	1/2"		
E-12289	8-delni set 1/4" udarnih nasadnih ključeva sa adapterom	6, 7, 8, 10, 11, 12, 13 mm	1/4"		
E-12354	3-delni set na 1/2 dubokih nasadnih ključeva za alu. Felne	86mm: 17, 19, 21mm	1/2"		

Akumulat  
ori i  
punjači

Pribor za  
akumulat  
orske  
alate

Akumulat  
orske  
lampe i  
pribor

Pribor za  
laserske  
merace









Pribor za  
rušenje i  
udarno  
bušenje

Pribor za  
bušenje

Krunaste  
testere

Pribor za  
pritezanje

## Produživači i adapteri

Model	Naziv	Ukupna dužina (mm)	Prihvati	Cena sa PDV-om	
134870-6	Nastavak	200	1"		
134873-0	Adapter za umetak 1/4 hex	50	1/2"		
134874-8	Nastavak	100	1/2"		
134877-2	Univerzalan deo za povezivanje	84	1/2"		
134997-2	Nastavak	150	3/4"		
191G67-2	Produžna ručka	657-807	/		
195870-1	Adapter za izvlačenje SDS-MAX burgija	160	1/2"		
B-54570	O-prsten za 1/2" nasadni ključ (3 kom)	/	1/2"		

Nastavak...

Pribor za  
sečenje i  
brusenje

Pribor za  
brusenje  
i  
poliranje

Pribor za  
profilisanje  
i  
poravnava

Pribor za  
višenam  
enski alat

Pribor za  
testere

Pribor za  
pneumat  
ske alate

Pribor za  
fenove  
za vrući  
vazduh

Pribor za  
usisivanje

Pribor za  
alate za  
rad na  
otvoreno

Pribor za  
držače  
alata i  
zaštitna

Koferi i  
torbe

Ručni  
alati

Ostalo

Pribor za  
mješanje

# Pribor za pritezanje

	Model	Naziv	Ukupna dužina (mm)	Prihvat	Cena sa PDV-om
	B-54617	Pin za 1/2" nasadni ključ (3 kom)	/	1/2"	
	B-54673	Adapter za 1/2" nasadne ključeve	50	1/4" hex	
	B-55706	Produžna drška SQ	250	1/2"	
	B-55712	Produžna drška SQ	150	1/2"	
	B-55728	Produžna drška SQ	75	1/2"	
	B-68448	Adapter za umetak 1/4 hex	51	1/2"	
	P-05941	Adapter za umetak 1/4 hex	50	1/2"	
	P-05963	Adapter za umetak 1/4 hex	55	3/8"	
	P-21559	O-prsten za brzoizmenljivi futer	/	1/2"	
	P-21565	Bezebednosna čivija za brzoizmenljivi futer	/	1/2"	



# PRIBOR ZA SEČENJE I BRUŠENJE

Mermer		Prirodni kamen	
Beton		Armirani beton	
Krečnjak		Modularna cigla	
Cigla		Porozna cigla	
Staklo		Glinene pločice	
Asfalt		Mekani pločasti kamen	
Aluminijum		Staklena vlakna	
Metali		Nerdajući čelik	
Drvo		Obojeni metali	
Granit		Plastika, PVC	
		Epoksy	
		Keramičke pločice	
		Uklanjanje boja	
		Završni rad	
		Aluminijum oksid	
		Keramički aluminijum oksid	
		Cirkonijum	
		Za mokru upotrebu	
		Za suhu upotrebu	
Akumulatorska ugaona brusilica			
Industrija - brodogradilišta			
Industrija - naftna postrojenja			
Fleksibilni brusni disk			
Tanak disk			
Potporna podloga			
Sigurnost i sigurnosna oprema			
Produžen vek trajanja			





Količina rada sa jednim punjenjem baterije



### TANKE REZNE PLOČE

Debljina 0.8 mm za brzo sečenje.

#### Tanja debljina

Debljina od 0,8 mm omogućava brzo sečenje, smanjenje otpora sečenju, manje neravnina i manje prašine.



Standard  
(1,0 mm debljina)



Idealan za  
akumulatorske alate  
(0,8 mm debljina)



100

20%  
više



120



### FLEKSIBILNE BRUSNE PLOČE

Niske vibracije i nema potrebe za korišćenjem pomoćne podloge.

#### Antivibraciona struktura

Dodat je materijal koji apsorbuje udarce kako bi se apsorbovale vibracije. Fleksibilnost omogućava veću brzinu brušenja i veću kontaktnu površinu sa radnim komadom.



Standard  
(115 x 6 mm debljina)



Idealan za  
akumulatorske alate  
(115 x 4 mm)



100

70%  
više



170

Za pločice



### TANKE DIJAMNTSKE PLOČE

Glatko sečenje bez napora.

#### Uprkos manjoj debljini, ima dovoljno snage

Debljina od 1,4 mm omogućava glatko sečenje uz vrlo malo napora.

Valoviti obod smanjuje vibracije i povećava trošenje materijala tokom sečenja.



Standard  
(2,3 mm debljina)



Idealan za  
akumulatorske alate  
(1,4 mm debljina)



100

60%  
više



160

Za beton / kamen

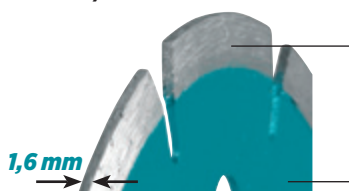

### Specijalizovano rezanje

Ovo sečivo je dizajnirano kao 1,6 mm, tako da je sečenje glatko i sa manje napora.

Dodavanjem rupa smanjili smo težinu ploče i tako smanjili opterećenje baterije i alata. Dužina rada sa jednim punjenjem baterije se povećava.



Standard  
(2,2 mm debljina)



Idealan za  
akumulatorske alate  
(1,6 mm debljina)



100

50%  
više



150

## X LOCK

Dijamantska ploča sa granulacijom od volframovog karbida

Tanke rezne ploče

Dijamantska ploča

Brusne ploče

Žičane četke



### BRZA ZAMENA

Smanjeno vreme za zamenu ploče/četke.



### PROMENA TOČKOVA/ ČETKICA BEZ ALATA

Jednostavan „klik“ sistem, bez potrebe za korišćenjem dodatnih alata.



Količina rada sa jednim punjenjem baterije

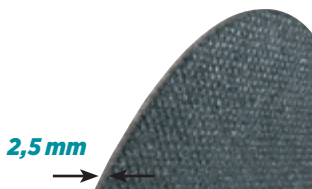

### ABRAZIVNE REZNE PLOČE ZA METAL

Dizajniran posebno za bežične prenosne testere za sečenje.

#### Tanja ploča sa optimalnim vezivanjem

Ploča debljine 2,5 mm za glatko i brzo sečenje. Optimalno vezivanje za brze, čiste rezove i duži životni vek ploče.



Standard  
(3,0 mm debljina)



Idealan za  
akumulatorske alate  
(2,5 mm debljina)



100

50%  
više



150

# DIJAMANTSKE REZNE PLOČE



**QUASAR**

Univerzalni profesionalni 3DDG dijamantske ploče za rezanje. Sa Stealth tehnologijom za manje vibracija i tihi rad. Brzi i čisti rezovi. Za suvo i mokro sečenje.



**COMET**

Poluprofesionalni 3DDG dijamantske ploče za rezanje. Deo asortimana uključuje Stealth tehnologiju za manje vibracija i tiši rad. Brzi i čisti rezovi.



**NEBULA**

3DDG dijamantske rezne ploče sa laserski zavarenim segmentima. Za suvo i mokro sečenje.



## TEHNOLOGIJA 3DDG

Za brže rezanje i duži radni vek

Tehnologija omogućava da svako pojedinačno dijamantsko zrno bude ravnomerno raspoređeno u trodimenzionalnom obrascu. U poređenju sa tradicionalnom izradom reznih ploča sa nasumičnom raspodelom zrna, rezne ploče izrađene u tehnologiji 3DDG imaju daleko bolje radne performanse.



## STEALTH TEHNOLOGIJA

Za manje buke i manje vibracija

Napredna tehnologija koja koristi laminirane rezne ploče, čime se obezbeđuje smanjena rezonancija i niži nivo buke tokom rada u odnosu na tradicionalno izrađene rezne ploče. Ove osobine posebno dolaze do izražaja u radu u urbanim sredinama. Stabilni listovi obezbeđuju čist i gladak rez.

MATERIJALI	QUASAR	COMET	NEBULA
Granit	◆◆	◆◆	◆
Tvrda opeka	◆◆	◆◆	◆
Tvrde glinene cigle	◆◆◆◆	◆◆◆◆	◆
Kaldrma	◆◆◆◆	◆◆◆◆	◆
Glinene cevi	◆◆◆◆◆	◆◆◆◆◆	◆
Tvrđi kamen	◆◆◆◆◆	◆◆◆◆◆	◆
Glinene pločice	◆◆◆◆◆	◆◆◆◆◆	◆
Srednje tvrdi kamen	◆◆◆◆◆	◆◆◆◆◆	◆◆
Tvrđi škriljac	◆◆◆◆◆	◆◆◆◆◆	◆◆
Teraco ploče	◆◆◆◆◆	◆◆◆◆◆	◆◆
Armirani beton	◆◆◆◆◆	◆◆◆◆◆	◆◆◆◆
Krečnjak	◆◆◆◆◆	◆◆◆◆◆	◆◆◆◆
Betonska T-greda	◆◆◆◆◆	◆◆◆◆◆	◆◆◆◆
Betonski ivičnjak	◆◆◆◆◆	◆◆◆◆◆	◆◆◆◆
Prana betonske ploče	◆◆◆◆◆	◆◆◆◆	◆◆◆◆
Betonske police	◆◆◆◆◆	◆◆◆◆	◆◆◆◆
Betonska cigla	◆◆◆◆◆	◆◆◆◆	◆◆◆◆
Mekani kamen	◆◆◆◆◆	◆◆	◆◆
Mekani škriljac	◆◆◆◆◆	◆◆	◆◆
Betonski crep	◆◆◆◆	◆◆	◆◆
Tvrđi peščani kamen	◆◆◆◆	◆	◆
Meki peščani kamen	◆◆	◆	◆
Košuljica	◆◆	◆	◆
Asfalt	◆◆	◆	◆

## ETIKETE NA DIJAMANTSKIM DISKOVIMA

Tip segmentnog ruba:  
DS: Diamant Segment  
DC: Diamant Continuous  
DA: Diamant Asphalt

Prečnik diska (mm)

Prečnik nasadnog otvora (mm)

Tip diska:  
Q: Quasar C: Comet  
N: Nebula L: Laser

**Q DS 300 22 XS**

Posebne karakteristike:  
C: sa otvorima za hlađenje  
V: pojačani vrh  
X: 3D-dijamantska struktura  
S: Stealth tehnologija

## DIJAMANTSKE REZNE PLOČE

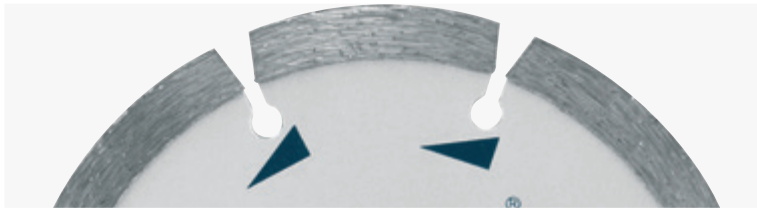

### SEGMENTNI TIP:

List ima proreze i sloj dijamanta sinterovanog po rubovima. Seče brže od neprekinutog kružnog tipa i proizvodi prosečnu obrađenu površinu.



### SEGMENTNI VALOVIT RUB:

Ploče imaju segmente sa prorezima / talasima koji omogućavaju brže rezanje sa manje otpora i poboljšano uklanjanje materijala koji se reže.

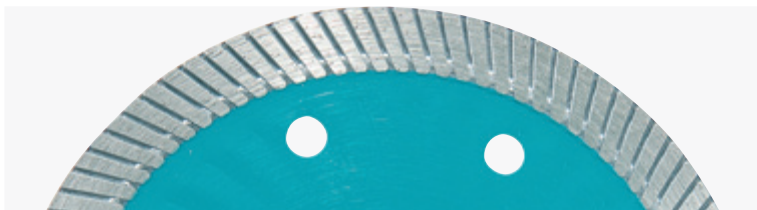

### TALASASTI TIP:

Ovaj disk ima žljebove oko ruba. Ima karakteristike između neprekinutog ruba i segmentnog tipa. Seče brže, kao segmentni tip. U isto vreme postiže čistiju površinu, kao neprekinuti rub, bez okržanih rubova.



### NEPREKINUTI KRUŽNI TIP:

Ima sloj dijamanta sa ravnomernom debljinom, po celom rubu. Postiže čistu površinu, čak i kod tvrdih, lomljivih materijala. Tačna širina sečenja, ali ne toliko brzo kao sa segmentnim diskom.

## DIJAMANTSKE REZNE PLOČE - SPECIALIZED



### ELEKTROLITIČKI TIP:

Dijamanti su elektrolitički i disk ima veću izloženost od vezivnog tipa. Sečenje je brže i efikasnije.

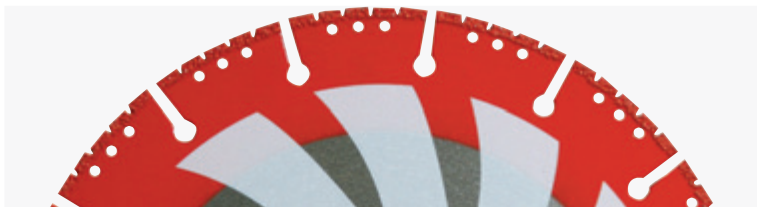

### VAKUMSKI ZALEMLJENO DIJAMANTSKO ZRNO:

Dijamanti se leme vakuumom, što ih čini više izloženim u poređenju sa standardnom primenom. Rezne ploče proizvedene ovom metodom imaju duži vek trajanja od ploča sa elektrodeponovanim česticama. Namenjene su za sečenje tvrdih materijala.

## KLASIFIKACIJA KVALITETA

### VRHUNSKI TIP

★★★

Ovaj tip daje najbolje performanse što se tiče brzine i izdržljivosti.

### STANDARDNI TIP

★★

Ovaj tip postiže optimalni balans između performansi i cene.

### EKONOMIČAN TIP

★

Ovaj tip je privlačan zbog razumne cene.

## Dijamantski listovi

### Quasar Stealth, 3DDG

Premijum univerzalni 3D mrežni dijamantski nož sa profesionalnim performansama. Quasar segmenti imaju potpuno koristan 12 mm segment sa „M“ oblikom. Dostupne sa Stealth tehnologijom daju male vibracije i buku za najbolji osećaj ili sa pojačanim centrom i hlađenjem rupa za brzo i udobno sečenje. Laserski zavareni, za mokar i suvi rad. Za sečenje: mermer, granit, armirani beton, beton, mekana/tvrda cigla, teraco, pločice od gline, pločasti kamen.

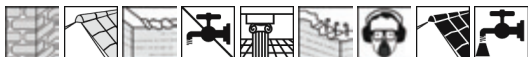

Model	Makita ID broj	Prečnik dijamantskog lista Ø (mm)	Prečnik nasadnog otvora Ø (mm)	Visina segmenta (mm)	Opis	Najveći broj obrtaja (min <sup>-1</sup> )	Cena sa PDV-om
B-12712	QDS23022XS	230	22,23	12	3DDG, tihi rad	6.650	
B-13459		300	20	12	3DDG, tihi rad	6.400	
B-17588		300	25,4	12	3DDG, tihi rad	6.400	
B-13465		350	25,4/20	12	3DDG, tihi rad	5.500	
B-13471		400	25,4/20	12	3DDG, tihi rad	4.770	

### Comet Universal sa rupama za hlađenje, 3DDG

Premijum univerzalni 3D mrežni dijamantski nož sa profesionalnim performansama. Široki spektar kvalitetnih noževa sa tehnologijom 3D mreža i opcionalne karakteristike kao što su stealth tehnologija ili hlađenje rupa. Laserski zavareni, za mokro i suvo korišćenje. Za brzo sečenje: betona, mekane/tvrde cigle, mermera, teraco, keramičkih pločica, krečnjaka i glinenih cevi.



Model	Makita ID broj	Prečnik dijamantskog lista Ø (mm)	Prečnik nasadnog otvora Ø (mm)	Visina segmenta (mm)	Opis	Najveći broj obrtaja (min <sup>-1</sup> )	Cena sa PDV-om
B-12762	CDS11522RC	115	22,23	10	3DDG, otvori za hlađenje	13.300	
B-12778	CDS12522RC	125	22,23/20	10	3DDG, otvori za hlađenje	12.250	
B-27187	CDS15022RC	150	22,23	10	3DDG, otvori za hlađenje	10.200	
B-27193	CDS18022RC	180	22,23	10	3DDG, otvori za hlađenje	8.500	
B-12784	CDS23022RCX	230	22,23	10	3DDG, otvori za hlađenje	6.650	
B-13546		300	20	10	3DDG, otvori za hlađenje	6.400	
B-17619		300	25,4	10	3DDG, otvori za hlađenje	6.400	
B-13552		350	25,4/20	10	3DDG, otvori za hlađenje	5.550	
B-13568		400	25,4/20	10	3DDG, otvori za hlađenje	4.800	

 Akumulat  
ori i  
punjači

 Pribor za  
akumulat  
orske  
alate

 Akumulat  
orske  
lampe i  
pribor

 Pribor za  
laserske  
merace

 Pribor za  
rušenje i  
udarno  
bušenje

 Pribor za  
bušenje

 Krunaste  
testere

 Pribor za  
pritezani  
e

 Pribor za  
sečenje i  
brušenje

 Pribor za  
brušenje  
i  
poliranje

 Pribor za  
profilisanj  
e i  
poravnaj

 Pribor za  
višenam  
enski alat

 Pribor za  
testere

 Pribor za  
pneumat  
ske alate

 Pribor za  
fenove  
za vrući  
vazduh

 Pribor za  
usisivanj  
e

 Pribor za  
alate za  
rad na  
otvoreno

 Pribor za  
držače  
alata i  
zaštitna

 Koferi i  
torbe

 Ručni  
alati

Ostalo

 Pribor za  
mješanje

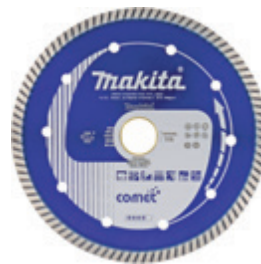

## Comet Turbo



Model	Makita ID broj	Prečnik dijamantskog lista Ø (mm)	Prečnik nasadnog otvora Ø (mm)	Visina segmenta (mm)	Opis	Cena sa PDV-om
B-12980	CTD11522	115	22,23	7	Turbo rim	
B-12996	CTD12522	125	22,23/20	7	Turbo rim	
B-13007	CTD15022	150	22,23/20	7	Turbo rim	
B-13013	CTD17522	175	22,23	7	Turbo rim	
B-13029	CTD20030	200	30/25,4	7	Turbo rim	
B-13035	CTD23022	230	22,23	8	Turbo rim	
B-13041	CTD30025	300	25,4	8,5	Turbo rim	
B-13057	CTD35025	350	25,4	8,5	Turbo rim	



## Comet segmentni tip - za asfalt, 3DDG

Najčešće korišćen. Nož ima procepe i sloj dijamanta koji je sinterovan na rubove. Seče brže od neprekidnog kružnog tipa i postiže prosečnu obrađenu površinu. Za sečenje: asfalta, grubog krečnjaka, krupnog kamena, abrazivnog krečnjaka i mekih blokova.



Model	Prečnik dijamantskog lista Ø (mm)	Prečnik nasadnog otvora Ø (mm)	Visina segmenta (mm)	Opis	Najveći broj obrtaja (min <sup>-1</sup> )	Cena sa PDV-om
B-13269	300	20	10	3DDG, Asphalt	6.360	
B-13275	350	25,4/20	10	3DDG, Asphalt	5.500	
B-42905	400	25,4/20	10	3DDG, Asphalt	4.800	



## Comet Continuous Rim - za brzo i tačno sečenje u tvrdim materijalima

Neprekidni kružni tip ima sloj od dijamanta sa uniformnom debljinom oko celog ruba. Može da postigne čistu površinu čak i kod lomljivih materijala. Seče sa tačnošću, ali ne toliko brzo kao segmentni disk. Za sečenje: keramičkih pločica i porcelana.



Model	Makita ID broj	Prečnik dijamantskog lista Ø (mm)	Prečnik nasadnog otvora Ø (mm)	Visina segmenta (mm)	Opis	Cena sa PDV-om
B-13063	CDC8015	80	15	5	kontinuirani rub	
B-13085	CDC11522	115	22,23	5	kontinuirani rub	
B-13091	CDC12522	125	22,23	5	kontinuirani rub	

[Nastavak...](#)

# Pribor za sečenje i brušenje

135

Model	Makita ID broj	Prečnik dijamantskog lista Ø (mm)	Prečnik nasadnog otvora Ø (mm)	Visina segmenta (mm)	Opis	Cena sa PDV-om
B-13100	CDC15022	150	22,23/20	5	kontinuirani rub	
B-13116	CDC17522	180	22,23	5	kontinuirani rub	
B-13122	CDC20030	200	30/25,4	5	kontinuirani rub	
B-13138	CDC23030	230	30/25,4	5	kontinuirani rub	
B-13144	CDC30025	300	25,4	7	kontinuirani rub	
B-13150	CDC35030	350	30/25,4	7	kontinuirani rub	



## Comet - za završnu obradu spojeva u građevinarstvu

Rezna ploča za građevinske materijale i završnu obradu spojeva u građevinarstvu



comet

Model	Makita ID broj	Prečnik dijamantskog lista Ø (mm)	Prečnik nasadnog otvora Ø (mm)	Visina segmenta (mm)	Širina segmenta (mm)	Opis	Najveći broj obrtaja (min <sup>-1</sup> )	Cena sa PDV-om
B-13247	CDM11522	115	22,23	6,5	6,4	segmentni rub	13.300	
B-13253	CDM12522	125	22,23	6,5	6,4	segmentni rub	12.250	



## Comet elektrolitički tip

Dijamanti su elektrohemijski nanešeni i imaju veću izloženost od vezanih tipova. Seku brže i efikasnije. Za sečenje: mermerna, staklenih vlakna, lesonita i GRP-a.



comet

Model	Makita ID broj	Prečnik dijamantskog lista Ø (mm)	Prečnik nasadnog otvora Ø (mm)	Opis	Najveći broj obrtaja (min <sup>-1</sup> )	Cena sa PDV-om
B-13172	CDE11522	115	22,23	Elektrolitički tip	13.300	
B-13188	CDE12522	125	22,23/20	Elektrolitički tip	12.250	
B-13194	CDE15022	150	22,23/20	Elektrolitički tip	10.200	
B-13203	CDE17522	175	22,23	Elektrolitički tip	8.500	
B-13219	CDE23022	230	22,23	Elektrolitički tip	6.650	
B-13225	CDE25022	250	22,23	Elektrolitički tip	15.300	

Akumulat  
ori  
punjači

Pribor za  
akumulat  
orske  
alate

Akumulat  
orske  
lampe i  
pribor

Pribor za  
laserske  
merace

Pribor za  
rušenje i  
udarno  
bušenje

Pribor za  
bušenje

Krunaste  
testere

Pribor za  
pritazani  
e

Pribor za  
sečenje i  
brušenje

Pribor za  
brušenje  
i  
poliranje

Pribor za  
profilisanj  
e i  
poravnaj

Pribor za  
višenam  
enski alat

Pribor za  
testere

Pribor za  
pneumat  
ske alate

Pribor za  
fenove  
za vrući  
vazduh

Pribor za  
usisivanj  
e

Pribor za  
alate za  
rad na  
otvoreno

Pribor za  
držače  
alata i  
zaštitna

Koferi i  
torbe

Ručni  
alati

Ostalo

Pribor za  
mješanje



## Nebula, laserski zavaren rub

Prikladno za suhu i mokru upotrebu. Za rezanje građevinskih materijala (zid, tvrdi beton, armirani beton, kamen). Prikladne za motorne rezače



Model	Prečnik dijamantskog lista Ø (mm)	Prečnik nasadnog otvora Ø (mm)	Visina segmenta (mm)	Opis	Cena sa PDV-om
B-53986	115	22,23	10	Laserski zavareni segmenti	
B-53992	125	22,23	10	Laserski zavareni segmenti	
B-54003	150	22,23	10	Laserski zavareni segmenti	
B-54019	180	22,23	10	Laserski zavareni segmenti	
B-54025	230	22,23	10	Laserski zavareni segmenti	
B-54031	300	20	10	Laserski zavareni segmenti	
B-54047	300	20	10	Laserski zavareni segmenti	
B-54053	350	25,4	10	Laserski zavareni segmenti	
B-54069	400	25,4	10	Laserski zavareni segmenti	
B-54075	450	25,4	10	Laserski zavareni segmenti	



## Ultra izdržljiva vakuumski lemljena dijamantska rezna ploča

Površina je prekrivena velikim česticama dijamantske prašine čime se omogućava rezanje tvrdih materijala. Višenamenski listovi režu različite vrste materijala, kao što su metal, beton, smola i kaljeno staklo. Čestice dijamantske prašine lemljene su direktno na metalnu osnovu ploče. Za DC brusilice ili sekače.



Model	Prečnik dijamantskog lista Ø (mm)	Prečnik nasadnog otvora Ø (mm)	Debljina (mm)	Najveći broj obrtaja (min <sup>-1</sup> )	Opis	Pogodno za	Cena sa PDV-om
B-55304	115	22,23	2,8	13.300	rub sa vakumski nanošenim dijamantskim česticama	metal, beton, smolu, drvo, plastiku i kaljeno staklo	
B-55310	125	22,23	2,8	12.250	rub sa vakumski nanošenim dijamantskim česticama	metal, beton, smolu, drvo, plastiku i kaljeno staklo	
B-55326	230	22,23	3,1	6.650	rub sa vakumski nanošenim dijamantskim česticama	metal, beton, smolu, drvo, plastiku i kaljeno staklo	
B-55332	300	25,4	3,4	6.400	rub sa vakumski nanošenim dijamantskim česticama	metal, beton, smolu, drvo, plastiku i kaljeno staklo	
B-55348	355	25,4	3,4	5.500	rub sa vakumski nanošenim dijamantskim česticama	metal, beton, smolu, drvo, plastiku i kaljeno staklo	





## Dijamanstske ploče sa sepcijalnim rubom sa vakumski nanošenim dijamantskim česticama.



Model	Prečnik dijamantskog lista Ø (mm)	Prečnik nasadnog otvora Ø (mm)	Visina segmenta (mm)	Debljina lista (mm)	Najveći broj obrtaja (min <sup>-1</sup> )	Opis	Pogodno za	Cena sa PDV-om
B-53693	125	22,23	1,5	1,3	12.250	rub sa vakumski nanošenim dijamantskim česticama	metal	
B-53718	230	22,23	1,5	1,3	6.650	rub sa vakumski nanošenim dijamantskim česticama	metal	



## Dijamantske ploče sa volfram karbidnim rubom

Lasersko varení volfram karbidni rub omogućava veliku brzinu rezanja i veću dugotrajnost ploče. Rezna ploča sa rubom od volfram karbida namenjena je za rezanje sa ugaonim brusilicama. Ploča je namenjena za rezanje gipsanih ploča, PVC i FRP materijala. Ploča NIJE NAMENJENA ZA REZANJE U DRVETU zbog velikog rizika od pojave povratnog udara što može dovesti do povreda.

Model	Prečnik dijamantskog lista Ø (mm)	Prečnik nasadnog otvora Ø (mm)	Najveći broj obrtaja (min <sup>-1</sup> )	Pogodno za	Za model	Cena sa PDV-om
B-57716	115	22,23	13.300	PVC, gipsane ploče, peskirane i vlaknaste materijale	115 mm ugaone brusilice	
B-57722	125	22,23	12.250	PVC, gipsane ploče, peskirane i vlaknaste materijale	125 mm ugaone brusilice	



## Dijamantski segmentni listovi za suvo sečenje



Model	Prečnik dijamantskog lista Ø (mm)	Prečnik nasadnog otvora Ø (mm)	Visina segmenta (mm)	Debljina lista (mm)	Najveći broj obrtaja (min <sup>-1</sup> )	Opis	Pogodno za	Cena sa PDV-om
A-84109	115	22,23	7	1,9	13.300	segmentni rub	beton	
B-53780	115	22,23	7	1,6	13.300	segmentni rub	granit, beton, mermer	
D-52750	115	22,23	7	1,8	13.300	segmentni rub	beton, mermer	
A-84115	125	22,23	7	1,9	12.200	segmentni rub	beton, mermer	
B-53796	125	22,23	7	1,6	12.250	segmentni rub	granit, beton, mermer	
D-41595	125	22,23	7	2,2	12.250	segmentni rub	beton	

Nastavak...

 Akumulat  
ori i  
punjači

 Pribor za  
akumulat  
orske  
alate

 Akumulat  
orske  
lampe i  
pribor

 Pribor za  
laserske  
merace

 Pribor za  
rušenje i  
udarno  
bušenje

 Pribor za  
bušenje

 Krunaste  
testere

 Pribor za  
pritezanje

 Pribor za  
sečenje i  
brušenje

 Pribor za  
brušenje  
i  
poliranje

 Pribor za  
profilisanje  
i  
poravnane

 Pribor za  
višenam  
enski alat

 Pribor za  
testere

 Pribor za  
pneumat  
ske alate

 Pribor za  
fenove  
za vrući  
vazduh

 Pribor za  
usisivanje

 Pribor za  
alate za  
rad na  
otvoreno

 Pribor za  
držače  
alata i  
zaštitna

 Koferi i  
torbe

 Ručni  
alati

Ostalo

 Pribor za  
mješanje

# Pribor za sečenje i brušenje

Model	Prečnik dijamantskog lista Ø (mm)	Prečnik nasadnog otvora Ø (mm)	Visina segmenta (mm)	Debljina lista (mm)	Najveći broj obrtaja (min <sup>-1</sup> )	Opis	Pogodno za	Cena sa PDV-om
D-52766	125	22,23	7	1,8	12.250	segmentni rub	beton, mermer	
B-06432	150	22,23	7	2,1	10.200	segmentni rub	beton	
P-22327	150	22,23	7	2,1	10.180	segmentni rub	abrazivni materijali	
A-84121	180	25,4	7	2,3	8.500	segmentni rub	beton	
D-41604	180	22,23	7	2,4	8.500	segmentni rub	beton	
D-52772	180	22,23	7	2,2	8.500	segmentni rub	beton, mermer	
A-84137	230	22,23	7	2,5	6.600	segmentni rub	beton	
D-41610	230	22,23	7	2,6	6.650	segmentni rub	beton	
D-52788	230	22,23	7	2,4	6.650	segmentni rub	beton, mermer	
E-02967	230	22,23	7	2,4	6.650	segmentni rub	beton	

Akumulat ori i punjači
Pribor za akumulat orske alate
Akumulat orske lampe i pribor
Pribor za laserske merace
Pribor za rušenje i udarno bušenje
Pribor za bušenje
Krunaste testere
Pribor za pritezanje
Pribor za sečenje i brušenje
Pribor za brušenje i poliranje
Pribor za profilisanje i poravnavanje
Pribor za višenamenski alat
Pribor za testere
Pribor za pneumatske alate
Pribor za fenove za vrući vazduh
Pribor za usisivanje
Pribor za alate za rad na otvoreno
Pribor za držače alata i zaštitna
Koferi i torbe
Ručni alati
Ostalo
Pribor za mješanje

# DIJAMANTSKE REZNE PLOČE

## Odlične za akumulatorske alate



### ZA PLOČICE



#### 1. Savršeno za akumulatorske alate

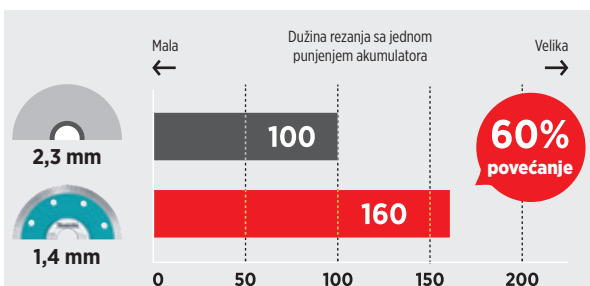

#### NAPOMENA:

1. Rezultati testa u velikoj meri zavise od tvrdoće materijala.
2. Vrednosti prikazane na grafikonu su relativne u odnosu na kapacitet Makita dijamantskog diska debljine 2,3 mm, kada je kapacitet označen vrednošću 100.

#### 2. Tanji list - lako i glatko rezanje



### ZA GRANIT, BETON I MERMER

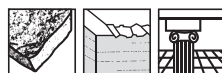

#### 1. Savršeno za akumulatorske alate

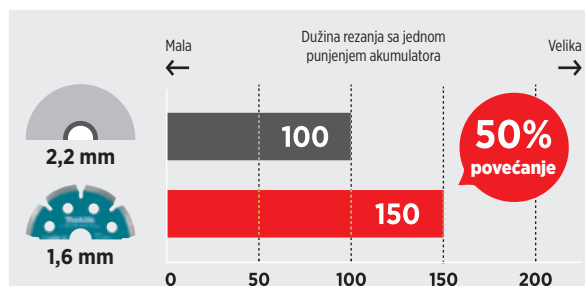

#### NAPOMENA:

1. Rezultati testa u velikoj meri zavise od tvrdoće materijala.
2. Vrednosti prikazane na grafikonu su relativne u odnosu na kapacitet Makita dijamantskog diska debljine 2,2 mm, kada je kapacitet označen vrednošću 100.

#### 2. Tanak i lagan list





## Dijamantski talasasti listovi za suvo sečenje



Model	Prečnik dijamantskog lista Ø (mm)	Prečnik nasadnog otvora Ø (mm)	Visina segmenta (mm)	Debljina lista (mm)	Najveći broj obrtaja (min <sup>-1</sup> )	Opis	Pogodno za	Cena sa PDV-om
A-84193	105	20	7	2	15.300	talasast tip	beton	
B-46327	115	22,23	10	1,4	13.300	talasast tip	keramičke ploče	
D-41626	115	22,23	7	2,3	13.300	talasast tip	beton	
D-52794	115	22,23	7	2,2	13.300	talasast tip	beton, mermer	
A-80438	125	22,23	7,5	2	12.220	talasast tip	beton	
B-46333	125	22,23	10	1,4	12.250	talasast tip	keramičke ploče	
D-41632	125	22,23	7	2,5	12.250	talasast tip	beton	
P-22311	150	22,23	7	2,4	10.180	talasast tip	beton	
A-84078	180	25,4	7	2,3	8.700	talasast tip	granit, beton	
D-41648	180	22,23	7	2,6	8.500	talasast tip	beton	
A-84171	230	22,23	7	2,6	6.640	talasast tip	beton	
D-41654	230	22,23	7	3,1	6.650	talasast tip	beton	
D-52825	230	22,23	7	1,8	6.650	talasast tip	beton, mermer	



## Dijamantski talasasti listovi za mokro sečenje



Model	Prečnik dijamantskog lista Ø (mm)	Prečnik nasadnog otvora Ø (mm)	Visina segmenta (mm)	Debljina lista (mm)	Najveći broj obrtaja (min <sup>-1</sup> )	Opis	Pogodno za	Za model	Cena sa PDV-om
B-22034	110	20	5	2	13.880	talasast tip	kamen	4101RH	



## Dijamantski listovi sa kontinuiranim rubom za suvo sečenje



Model	Prečnik dijamantskog lista Ø (mm)	Prečnik nasadnog otvora Ø (mm)	Debljina lista (mm)	Najveći broj obrtaja (min <sup>-1</sup> )	Opis	Pogodno za	Cena sa PDV-om
D-52716	110	22,23	1,8	13.880	kontinuiranim rub	keramičke ploče	



## Dijamantski listovi sa kontinuiranim rubom



Model	Prečnik dijamantskog lista Ø (mm)	Prečnik nasadnog otvora Ø (mm)	Visina segmenta (mm)	Debljina lista (mm)	Najveći broj obrtaja (min <sup>-1</sup> )	Opis	Pogodno za	Za model	Cena sa PDV-om
B-21098	85	15	5	1,8	4.500	kontinuiranim rub	pločice, staklo	CC300DW, CC301D	



## Reducirni prsteni

Model	Unutrašnji prečnik (mm)	Spoljni prečnik (mm)	Jedinica (kom/kompl)	Cena sa PDV-om
A-85248	20	22,23	10/1	
A-86860	16	20	10/1	

Akumulatori i punjači

Pribor za akumulatorske alate

Akumulatorske lampe i pribor

Pribor za laserske merace

Pribor za rušenje i udarno bušenje

Pribor za bušenje

Krunaste testere

Pribor za pritezanje

Pribor za sečenje i brušenje

Pribor za brušenje i poliranje

Pribor za profilisanje i poravnavanje

Pribor za višenamenski alat

Pribor za testere

Pribor za pneumatske alate

Pribor za fenove za vrući vazduh

Pribor za usisivanje

Pribor za alate za rad na otvoreno

Pribor za držače alata i zaštitna

Koferi i torbe

Ručni alati

Ostalo

Pribor za mješanje



### X-LOCK dijamantski segmentni listovi za suvo sečenje

Postavljanje/uklanjanje bez korišćenja alata. Sprečava prejako pritezanje i labavost diskova.



Model	Prečnik dijamantskog lista Ø (mm)	Prihvata	Debljina lista (mm)	Visina segmenta (mm)	Najveći broj obrtaja (min <sup>-1</sup> )	Opis	Pogodno za	Cena sa PDV-om
E-02060	115	X-LOCK	2.2	7	13.300	segmentni rub	granit, beton, mermer	
E-02076	125	X-LOCK	2.2	7	12.250	segmentni rub	granit, beton, mermer	



### X-LOCK dijamantske ploče sa volfram karbidnim rubom

Postavljanje/uklanjanje bez korišćenja alata. Sprečava prejako pritezanje i labavost diskova.

Model	Debljina lista (mm)	Prečnik dijamantskog lista Ø (mm)	Najveći broj obrtaja (min <sup>-1</sup> )	Prihvata	Pogodno za	Za model	Cena sa PDV-om
E-11776	2	125	12.250	X-LOCK	PVC, gipsane ploče, peskirane i vlaknaste materijale	X-LOCK ugaone brusilice	

## DIJAMANTSKI TANJIRASTI BRUSNI DISKOVİ

### JEDNOREDNA

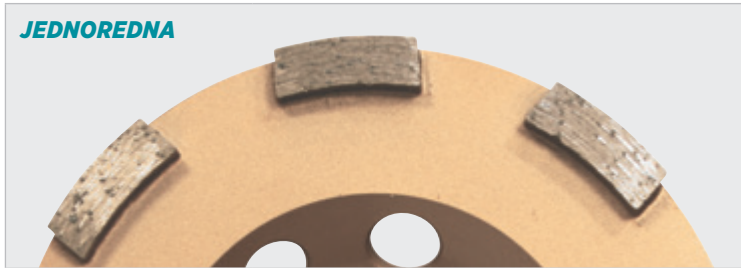

#### **Gruba obrada**

Brži i efikasniji od standardnih radnih diskova. Namenjen za uklanjanje većih količina materijala.

### DVOREDNA

### SEGMENTNA

### VENTILIRAJUĆA



#### **Standardni poslovi**

Prema specifikacijama, ovi diskovi su namenjeni za poslove između grubog i finog rada. Koriste se za srednju brzinu uklanjanja materijala i za postizanje čiste i glatke površine.

### TURBO TIP

### GLATKA IVICA



#### **Završni poslovi**

Namenjen za fino brušenje površina, završne radove i precizno oblikovanje ivica i uglova.

## SPECIALIZED

### PCD



#### **Skidanje boja**

Ovi diskovi se koriste za uklanjanje poliuretana, lepka, boje, epoksida i akrilnih premaza.

Zubi su napravljeni od polikristalnog dijamanta (PCD) za visoku izdržljivost, visoku efikasnost i glatkiju završnu obradu površine.

## ZA SMANJENJE VIBRACIJA

### NISKE VIBRACIJE

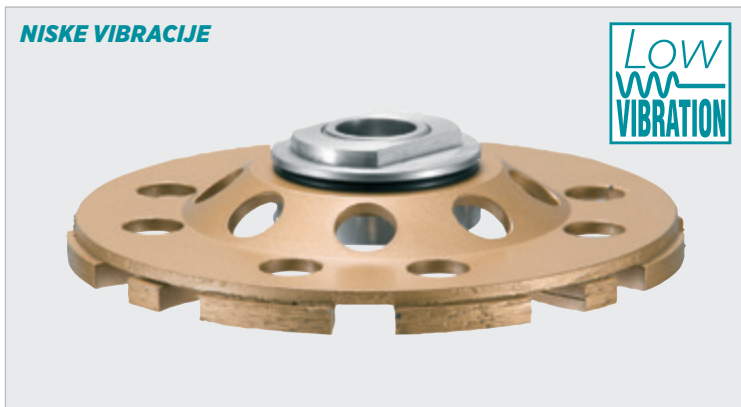

#### **Niske vibracije**

Dva gumena prstena potiskuju vibracije i smanjuju prenos vibracija na korisnika što u velikoj meri smanjuje umor pri radu.

#### **Povećana stabilnost**

Manje vibracija znači bolji kontakt površine za brže, efikasnije i ravnomernije brušenje.

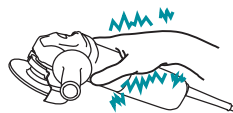

standardno

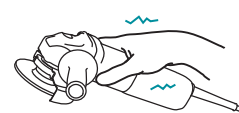

sa smanjenim vibracijama

## Brusni i diskovi za poliranje

### Dijamantski tanjirasti brusni diskovi

Izaberite između segmentne glave za grubu obradu ili kontinuirane glatke glave za završnu obradu. Fino: Kontinuirani dijamantski brusni disk je idealan za završnu obradu. Grubo: Segmentni dijamantski brusni disk je idealan za grubu obradu.



	Model	Naziv	Prečnik Ø (mm)	Prečnik nasadnog otvora Ø (mm)	Širina segmenta (mm)	Visina segmenta (mm)	Pogodno za	Za model	Najveći broj obrtaja (min <sup>-1</sup> )	Cena sa PDV-om
	A-07369	Dijamantski brusni disk za suvo brušenje	110	15	13,5	4	opšte namene	PC1100	13.900	
	D-60676	Asimetrična dijamantska rezna ploča (jednoredna)	115	22,23	8	5	gruba obrada	115 mm ugaone brusilice	13.300	
	D-62315	Asimetrična dijamantska rezna ploča (dvoredna)	115	22,23	8	5	opšte namene	115 mm ugaone brusilice	13.300	
	D-62343	Asimetrična dijamantska rezna ploča (Turbo)	115	22,23	8	5	završni radovi	115 mm ugaone brusilice	13.300	
	B-12289	Dijamantski brusni disk za finu obradu	125	22,23	14,2	4,2	završni radovi	PC5000, PC5001C, 125 mm ugaone brusilice	12.200	
	B-12295	Dijamantski brusni disk za grubu obradu	125	22,23	8	5	gruba obrada	PC5000, PC5001C, 125 mm ugaone brusilice	12.200	
	B-38560	Anti-vibracioni disk	125	M14	/	/	opšte namene	125 mm ugaone brusilice	12.200	
	B-48533	Tanjirasti dijamantski disk	125	M14	8	5,5	gruba obrada	125 mm ugaone brusilice	12.200	
	B-48549	Tanjirasti dijamantski disk	125	M14	8	5,5	gruba obrada	125 mm ugaone brusilice	12.200	
	B-48555	Tanjirasti dijamantski disk	125	M14	7	5,5	opšte namene	125 mm ugaone brusilice	12.200	
	B-48577	Tanjirasti dijamantski disk	125	22,23	8	5,5	gruba obrada	PC5000, PC5001C, 125 mm ugaone brusilice	12.200	

[Nastavak...](#)



# Pribor za sečenje i brušenje



Model	Naziv	Prečnik Ø (mm)	Prečnik nasadnog otvora Ø (mm)	Širina segmenta (mm)	Visina segmenta (mm)	Pogodno za	Za model	Najveći broj obrtaja (min <sup>-1</sup> )	Cena sa PDV-om
B-48583	Tanjirasti dijamantski disk	125	22,23	7	5,5	opšte namene	PC5000, PC5001C, 125 mm ugaone brusilice	12.200	
B-53160	PCD dijamantska brusna ploča	125	22,23	/	/	skidanje poliuretana, boje, lepka, smole i akrila	PC5000, PC5001C, 125 mm ugaone brusilice	12.200	
D-41458	Tanjirasti dijamantski disk	125	22,23	7,5	5,3	gruba obrada	PC5000, PC5001C	12.250	
D-41464	Tanjirasti dijamantski disk	125	22,23	13	4,2	završni radovi	PC5000, PC5001C	12.250	
D-60682	Asimetrična dijamantska rezna ploča (jednoredna)	125	22,23	8	5	gruba obrada	PC5000, PC5001C, 125 mm ugaone brusilice	12.250	
D-66715	Asimetrična dijamantska rezna ploča (dvoredna)	125	22,23	7	5,5	opšte namene	125 mm ugaone brusilice	12.250	
D-66721	Asimetrična dijamantska rezna ploča (Turbo)	125	22,23	13	4,2	završni radovi	125 mm ugaone brusilice	12.250	
B-48608	Tanjirasti dijamantski disk	180	M14	8	5	gruba obrada	180 mm ugaone brusilice	8.500	
B-48614	Tanjirasti dijamantski disk	180	M14	7	5	opšte namene	180 mm ugaone brusilice	8.500	
B-48620	Tanjirasti dijamantski disk	180	M14	20	5	završni radovi	180 mm ugaone brusilice	8.500	
B-48642	Tanjirasti dijamantski disk	180	22,23	8	5	gruba obrada	180 mm ugaone brusilice	8.500	
B-48658	Tanjirasti dijamantski disk	180	22,23	7	5	opšte namene	180 mm ugaone brusilice	8.500	
B-48664	Tanjirasti dijamantski disk	180	22,23	20	5	završni radovi	180 mm ugaone brusilice	8.500	

Nastavak...





- Akumulat orni i punjači
- Pribor za akumulat orske alate
- Akumulat orske lampe i pribor
- Pribor za laserske merace
- Pribor za rušenje i udarno bušenje
- Pribor za bušenje
- Krunaste testere
- Pribor za pritezanje
- Pribor za sečenje i brušenje
- Pribor za brušenje i poliranje
- Pribor za profilisanje i poravnavanje
- Pribor za višenamenski alat
- Pribor za testere
- Pribor za pneumatike alate
- Pribor za fenove za vrući vazduh
- Pribor za usisivanje
- Pribor za alate za rad na otvoreno
- Pribor za držače alata i zaštitna
- Koferi i torbe
- Ručni alati
- Ostalo
- Pribor za mješanje

# Pribor za sečenje i brušenje

	Model	Naziv	Prečnik Ø (mm)	Prečnik nasadnog otvora Ø (mm)	Širina segmenta (mm)	Visina segmenta (mm)	Pogodno za	Za model	Najveći broj obrtaja (min <sup>-1</sup> )	Cena sa PDV-om
	D-62290	Asimetrična dijamantska rezna ploča (jednoredna)	180	22,23	8	5	gruba obrada	180 mm ugaone brusilice	8.500	
	D-62321	Asimetrična dijamantska rezna ploča (dvoredna)	180	22,23	8	5	opšte namene	180 mm ugaone brusilice	8.500	
	D-62359	Asimetrična dijamantska rezna ploča (Turbo)	180	22,23	8	5	završni radovi	180 mm ugaone brusilice	8.500	

## Štitnici za prašinu

	Model	Naziv	Za model	Cena sa PDV-om
	424525-4	Štitnik za prašinu	PC5000C, PC5001C	
	424526-2	Štitnik za prašinu	PC5000C, PC5001C	
	743340-0	Četka A	PC5000C, PC5001C	
	743341-8	Četka B	PC5000C, PC5001C	



743080-0



## Dijamantski diskovi



Model	Naziv	Prečnik Ø (mm)	Granulacija	Za model	Jedinica (kom/kompl)	Cena sa PDV-om
154662-7	Štitnik	/	/	PW5000CH	1	
443121-9	Četka za skupljanje prašine	/	/	PW5000CH	1	
743080-0	Jastučić	100	/	PW5000CH	1	
D-15584	Dijamantski jastučić za poliranje	100	50	PW5000CH	1	
D-15590	Dijamantski jastučić za poliranje	100	100	PW5000CH	1	
D-15609	Dijamantski jastučić za poliranje	100	200	PW5000CH	1	
D-15615	Dijamantski jastučić za poliranje	100	400	PW5000CH	1	
D-15621	Dijamantski jastučić za poliranje	100	800	PW5000CH	1	
D-15637	Dijamantski jastučić za poliranje	100	1.500	PW5000CH	1	

[Nastavak...](#)

# Pribor za sečenje i brušenje

Model	Naziv	Prečnik Ø (mm)	Granulacija	Za model	Jedinica (kom/kompl)	Cena sa PDV-om
D-15643	Dijamantski jastučić za poliranje	100	3.000	PW5000CH	1	
D-15659	Dijamantski jastučić za poliranje	100	/	PW5000CH	1	
D-15805	Dijamantski jastučić za poliranje	100	50-3.000	PW5000CH	8/1	

## Jastučići za poliranje



Model	Naziv	Prečnik Ø (mm)	Granulacija	Za model	Cena sa PDV-om	
P-50077	Držač za podlogu za poliranje, M14	100	/	PW5000CH		
P-50108	Podložni jastučić za poliranje	100	400	PW5000CH		
P-50114	Podložni jastučić za brušenje	100	600	PW5000CH		
P-52152	Podložni jastučić za brušenje	100	220	PW5000CH		
P-52168	Podložni jastučić za brušenje	100	320	PW5000CH		

Akumulat  
ori  
punjači

Pribor za  
akumulat  
orske  
lampe i  
alate

Akumulat  
orske  
lampe i  
pribor

Pribor za  
laserske  
merace

Pribor za  
rušenje i  
udarno  
bušenje

Pribor za  
bušenje

Krunaste  
testere

Pribor za  
pritzanje

Pribor za  
sečenje i  
brušenje

Pribor za  
brušenje  
i  
poliranje

Pribor za  
profilisanje  
i  
poravnavanje

Pribor za  
višenamenski  
alati

Pribor za  
testere

Pribor za  
pneumatske  
alate

Pribor za  
fenove  
za vrući  
vazduh

Pribor za  
usisivanje

Pribor za  
rad na  
otvoreno

Pribor za  
držače  
alata i  
zaštita

Koferi i  
torbe

Ručni  
alati

Ostalo

Pribor za  
mješanje

## Krone sa vakumski lemljenim dijamentima za ugaone brusilice



### Krone sa vakumski lemljenim dijamentima za ugaone brusilice

Za ugaone brusilice sa M14 navojem. Vrh dijamantske krune izrađen je od vakumski zalemljenih dijamanata visokog kvaliteta. Ovim postupkom vezivanja materijala dobija se spoj koji je značajno čvršći u poređenju sa drugim metodama.



Model	Prečnik Ø (mm)	Prihvata (mm)	Najveći broj obrtaja (min <sup>-1</sup> )	Cena sa PDV-om
D-61064	5	M14	12.000	
D-61070	6	M14	12.000	
D-61086	8	M14	12.000	
D-61092	10	M14	12.000	
D-61101	12	M14	12.000	
D-44432	14	M14	12.000	
D-44448	16	M14	12.000	
D-44454	20	M14	12.000	
D-44460	22	M14	12.000	
D-44476	25	M14	12.000	
D-44482	27	M14	12.000	
D-44498	30	M14	12.000	
D-44507	32	M14	12.000	
D-44513	35	M14	12.000	
D-44529	38	M14	12.000	
D-44535	40	M14	12.000	
D-44541	45	M14	12.000	
D-44557	51	M14	12.000	
D-44563	55	M14	12.000	
D-44579	57	M14	12.000	
D-44585	60	M14	12.000	
D-44591	65	M14	12.000	
D-44600	67	M14	12.000	
D-44616	68	M14	12.000	
D-44622	70	M14	12.000	
D-44638	75	M14	12.000	
D-44644	80	M14	12.000	
D-44650	83	M14	12.000	

Akumulat  
ori i  
punjači

Pribor za  
akumulat  
orske  
alate

Akumulat  
orske  
lampe i  
pribor

Pribor za  
laserske  
merace

Pribor za  
rušenje i  
udarno  
bušenje

Pribor za  
bušenje

Krunaste  
testere

Pribor za  
pritezanje

Pribor za  
sečenje i  
brušenje

Pribor za  
brušenje  
i  
poliranje

Pribor za  
profilisanje  
i  
poravnava

Pribor za  
višenam  
enski alat

Pribor za  
testere

Pribor za  
pneumat  
ske alate

Pribor za  
fenove  
za vrući  
vazduh

Pribor za  
usisivanje

Pribor za  
alate za  
rad na  
otvoreno

Pribor za  
držače  
alata i  
zaštitna

Koferi i  
torbe

Ručni  
alati

Ostalo

Pribor za  
mješanje

# OZNAKE NA DISKOVIMA ZA SEČENJE I BRUŠENJE

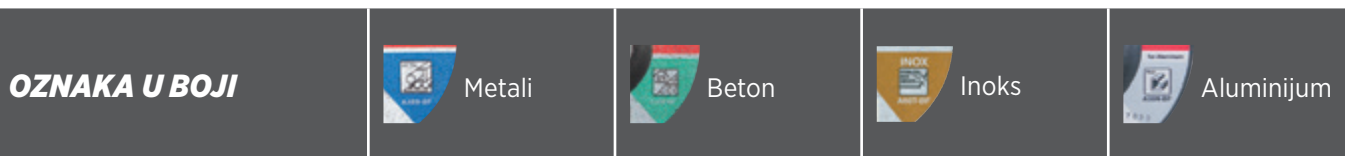

## ZNAČENJE OZNAKA



### GRUPA ALUMINIJUM OKSIDA

- A** Spojeni aluminijum
- C** Silicijum karbid
- WA** Aluminijum oksid
- Z** Aluminijum cirkonijum



### GRANULACIJA

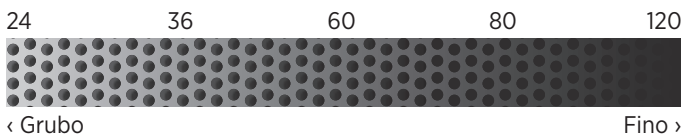

### TVRDOĆA BRUSNOG DISKA

Mekani brusni diskovi ▶ Tvrdi radni komadi ▶ Tvrdi brusni diskovi ▶ Mekani radni komadi

- |             |       |         |       |            |
|-------------|-------|---------|-------|------------|
| Mnogo mekan | Mekan | Srednje | Tvrd  | Mnogo tvrd |
| A - G       | H - K | L - O   | P - S | T - Z      |
- Bliže do A - mekši brusni diskovi  
Bliže do Z - tvrdi brusni diskovi



### VRSTA VEZIVA

Smolasto vezivo = Resinoid (BF)  
Osnovna komponenta je fenolna smola, mehanički jaka, ali nije otporna na vlagu i na visoke temperature.

# SERIJA BRUSNIH DISKOVA

## TANAK DISK

za akumulatorsku ugaonu brusilicu



### KARAKTERISTIKE SERIJE DC

Visoka efikasnost koja smanjuje vreme obavljanja posla.  
Povećana autonomija rada sa jednim punjenjem akumulatora.

### MATERIJALI



### KOLIČINA RADA

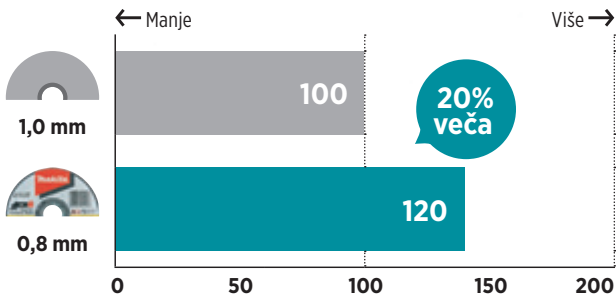

NAPOMENA: 1. Rezultati testiranja velikim delom zavise o tvrdoći materijala itd. 2. Brojevi na grafikonu su relativne vrednosti pri kapacitetu Makita ploče za rezanje (debljine: 1,0 mm) jednak indeksu 100.

### POREĐENJE



## BRUSNI DISKOVI

za tešku industriju



### KARAKTERISTIKE

Dugačak radni vek.  
Visoke performanse za industrijsku upotrebu.

### MATERIJALI



### VEK TRAJANJA

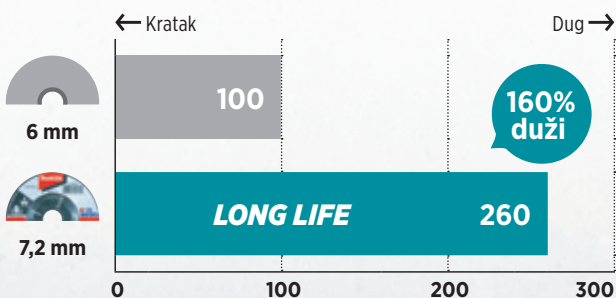

### DEBLJINA

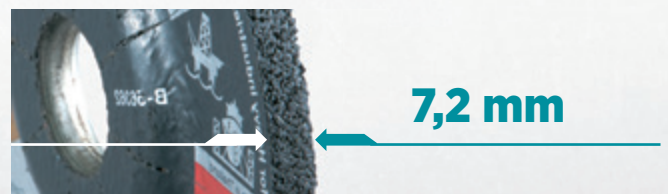

## Disk za sečenje



### Diskovi za sečenje nerđajućih čelika

• Tanki, srednje tvrdi, sa visokim performansama diskovi za sečenje • Nisko opterećenje motora, niži troškovi materijala, disk za sečenje sa uštedom energije • Isključivo visoki kapacitet sečenja i optimalan životni vek



Model	Tip brusnog diska	Prečnik diska (Ø) (mm)	Unutrašnji prečnik (Ø) (mm)	Debljina diska (mm)	Najveći broj obrtaja (min <sup>-1</sup> )	Opis	Cena sa PDV-om
B-45755	A36S	115	22,23	1,6	13.300	ravni	
B-46947	Z60T	115	22,23	0,8	13.300	sa presovanim centrom	
D-18764	WA60T	115	22,23	1,2	13.290	ravni	
E-03034	A60U	115	22,23	1,0	13.300	ravni	
E-10861	Z60U	115	22,23	0,8	12.250	ravni	
B-46931	A36S	125	22,23	1,6	12.250	ravni	
D-18770	WA60T	125	22,23	1,2	12.200	ravni	
E-03040	A60U	125	22,23	1,0	12.250	ravni	
E-10877	Z60U	125	22,23	0,8	12.250	ravni	
B-12251	A60T	150	22,23	1,6	10.200	ravni	
B-12267	A60T	180	22,23	1,6	8.500	ravni	
B-60458	A36S	180	22,23	1,8	8.500	ravni	
D-18786	WA36R	180	22,23	2,0	8.600	ravni	
B-12273	A60T	230	22,23	1,9	6.650	ravni	
B-60464	A36S	230	22,23	2,0	6.600	ravni	
D-18792	WA36R	230	22,23	2,0	6.600	ravni	
D-18845	WA36R	230	22,23	2,0	6.600	sa presovanim centrom	
E-03006	WA36R	230	22,23	2,0	6.650	ravni	
E-13764	A60U	230	22,23	1,9	6.650	ravni	



### Diskovi za sečenje nerđajućih čelika u kutiji



Model	Tip brusnog diska	Prečnik diska (Ø) (mm)	Unutrašnji prečnik (Ø) (mm)	Debljina diska (mm)	Najveći broj obrtaja (min <sup>-1</sup> )	Opis	Jedinica (kom/kompl)	Cena sa PDV-om
D-18764-10	WA60T	115	22,23	1,2	13.290	ravni	10/1	

E-03034-12	A60U	115	22,23	1,0	13.300	ravni	12/1	
------------	------	-----	-------	-----	--------	-------	------	--

Nastavak...

Akumulatori i punjači

Pribor za akumulatorske alate

Akumulatorske lampe i pribor

Pribor za laserske merace

Pribor za rušenje i udarno bušenje

Pribor za bušenje

Krunaste testere

Pribor za pritzanje

Pribor za sečenje i brušenje

Pribor za brušenje i poliranje

Pribor za profilisanje i poravnane

Pribor za višenamenski alat

Pribor za testere

Pribor za pneumatske alate

Pribor za fenove za vrući vazduh

Pribor za usisivanje

Pribor za alate za rad na otvoreno

Pribor za držače alata i zaštitna

Koferi i torbe

Ručni alati

Ostalo

Pribor za mješanje

# Pribor za sečenje i brušenje

	Model	Tip brusnog diska	Prečnik diska (Ø) (mm)	Unutrašnji prečnik (Ø) (mm)	Debljina diska (mm)	Najveći broj obrtaja (min <sup>-1</sup> )	Opis	Jedinica (kom/kompl)	Cena sa PDV-om
	B-45733-12	Z60T	125	22,23	0,8	12.250	ravni	12/1	
	D-18770-10	WA60T	125	22,23	1,2	12.200	ravni	10/1	
	D-18770-100	WA60T	125	22,23	1,2	12.200	ravni	100/1	
	E-03040-12	A60U	125	22,23	1,0	12.250	ravni	12/1	

## Diskovi za sečenje metala

• Hladno presovani, sa smolom vezani diskovi za sečenje • Visoki kapacitet sečenja i duži radni vek



Model	Tip brusnog diska	Prečnik diska (Ø) (mm)	Unutrašnji prečnik (Ø) (mm)	Debljina diska (mm)	Najveći broj obrtaja (min <sup>-1</sup> )	Opis	Jedinica (kom/kompl)	Cena sa PDV-om
D-18568	A30S	115	22,23	3	13.290	sa presovanim centrom	1	
D-18661	A30S	115	22,23	2,5	13.290	ravni	1	
A-85313	A30R	125	22,23	2,5	12.230	ravni	1	
D-18574	A30S	125	22,23	3	12.200	sa presovanim centrom	1	
D-18677	A30S	125	22,23	2,5	12.200	ravni	1	
D-18683	A30S	180	22,23	2,5	8.600	ravni	1	
A-85335	A30R	230	22,23	2,5	6.650	ravni	1	
D-18596	A30S	230	22,23	3	6.600	sa presovanim centrom	1	
D-18699	A30S	230	22,23	2,5	6.600	ravni	1	
B-10665-5	A36P	355	25,4	3	4.400	ravni	5/1	
B-49448-5	A36P-BF	355	25,4	2,5	4.400	ravni	5/1	
B-64353-5	A30P	355	25,4	3	4.400	ravni	5/1	
B-64696-5	A36P	355	25,4	2,5	4.400	ravni	5/1	
E-12790-5	A24T	355	25,4	4	5.500	ravni	5/1	





## THIN diskovi za sečenje aluminija



Model	Tip brusnog diska	Prečnik diska (Ø) (mm)	Unutrašnji prečnik (Ø) (mm)	Debljina diska (mm)	Najveći broj obrtaja (min <sup>-1</sup> )	Opis	Cena sa PDV-om
B-45331	A60T	125	22,23	1	12.250	ravni	



## X-LOCK diskovi za sečenje nerđajućih čelika

Postavljanje/uklanjanje bez korišćenja alata. Sprečava prejako pritezanje i labavost diskova. Odgovara svim X-LOCK ugaonim brusilicama i svim aktuelnim ugaonim brusilicama koje koriste navrtku za montiranje diska.



Model	Tip brusnog diska	Prečnik diska (Ø) (mm)	Prihvatač	Debljina diska (mm)	Najveći broj obrtaja (min <sup>-1</sup> )	Opis	Cena sa PDV-om
E-00387	A60T	115	X-LOCK	1,2	13.300	ravni	
E-00418	A60T	125	X-LOCK	1,2	12.250	ravni	

E-10724



## Tanke višenamenske ploče

Model	Naziv	Debljina diska (mm)	Prečnik diska (Ø) (mm)	Unutrašnji prečnik (Ø) (mm)	Tip brusnog diska	Najveći broj obrtaja (min <sup>-1</sup> )	Opis	Cena sa PDV-om
E-1072	Tanka višenamenska ploča	1,2	125	22,23	C46T	12.250	ravni	

Akumulat  
ori i  
punjači

Pribor za  
akumulat  
orske  
alate

Akumulat  
orske  
lampe i  
pribor

Pribor za  
laserske  
merace

Pribor za  
rušenje i  
udarno  
bušenje

Pribor za  
bušenje

Krunaste  
testere

Pribor za  
pritezanje

Pribor za  
sečenje i  
brušenje

Pribor za  
brušenje  
i  
poliranje

Pribor za  
profilisanje  
i  
poravnava

Pribor za  
višenam  
enski alat

Pribor za  
testere

Pribor za  
pneumat  
ske alate

Pribor za  
fenove  
za vrući  
vazduh

Pribor za  
usisivanje

Pribor za  
alate za  
rad na  
otvoreno

Pribor za  
držače  
alata i  
zaštitna

Koferi i  
torbe

Ručni  
alati

Ostalo

Pribor za  
mješanje

## Brusni disk sa presovanim centrom



## Brusni diskovi sa presovanim centrom za nerđajuće čelike



Model	Tip brusnog diska	Prečnik brusnog diska (Ø) (mm)	Unutrašnji prečnik (Ø) (mm)	Debljina diska (mm)	Najveći broj obrtaja (min <sup>-1</sup> )	Gena sa PDV-om
A-80640	WA36N	115	22,23	6	13.290	
A-80656	WA36N	125	22,23	6	12.200	

## Brusni diskovi sa presovanim centrom za čelik



Makita brusni diskovi su univerzalni srednje tvrdi diskovi za korišćenje u svim oblastima obrade metala. Brusni diskovi imaju krupno zrno i koriste se za skidanje velike količine materijala. Izbrušena površina je odgovarajuće gruba. Primena: • Čišćenje šavova od zavarivanja • Čišćenje odlivaka • Brušenje rubova i površina • Uređivanje tesnih zavarenih spojeva • Uređivanje korena zavarenih spojeva • Obaranje rubova Hladno presovani, sa smolom vezani srednje tvrdi univerzalni brusni diskovi za generalnu obradu čelika, npr. za obaranje rubova, brušenje ivica i površina. Posebna prednost je visoko nivo uklanjanja i duži vek.



Model	Tip brusnog diska	Prečnik brusnog diska (Ø) (mm)	Unutrašnji prečnik (Ø) (mm)	Debljina diska (mm)	Najveći broj obrtaja (min <sup>-1</sup> )	Jedinica (kom/kompl)	Gena sa PDV-om
A-80927	A36P	115	22,23	6	13.300	1	
D-18459	A24R	115	22,23	6	13.290	1	
D-18459-20	A24R	115	22,23	6	13.290	20/1	
D-74485	A24P	115	22,23	6	13.300	1	
A-80933	A36P	125	22,23	6	12.230	1	
D-18465	A24R	125	22,23	6	12.200	1	
D-18465-20	A24R	125	22,23	6	12.200	20/1	
D-74491	A24P	125	22,23	6	12.250	1	
D-18471	A24R	180	22,23	6	8.600	1	
A-80955	A36P	230	22,23	6	6.500	1	
D-18487	A24R	230	22,23	6	6.600	1	
D-74522	A24P	230	22,23	6	6.650	1	

## Specijalni obloženi diskovi za čišćenje

Specijalni brusni diskovi za brušenje različitih materijala. Granule diskova su od SiC - silicijum karbida, koje su vezane sa lepkom koji omogućava brzo brušenje sa malom snagom. Vlakna deluju kao jastuk i sprečavaju preveliko brušenje ili grebanje površine čelika. Površina diska je mnogo fina. Primena: uklanjanje boja, korozije, brušenje zavarenih šavova. Boja: crna - standardna, ljubičasta – dugačak vek.



Model	Prečnik brusnog diska (Ø) (mm)	Unutrašnji prečnik (Ø) (mm)	Podloga	Vlakna	Najveći broj obrtaja (min <sup>-1</sup> )	Cena sa PDV-om
B-28977	115	22,23	fiberglas	crna	12.000	
B-29016	115	22,23	fiberglas	ljubičasta	12.000	
B-29050	115	22,23	najlon	crna	12.000	
B-36251	115	22,23	najlon	ljubičasta	12.000	
B-28983	125	22,23	fiberglas	crna	12.000	
B-29022	125	22,23	fiberglas	ljubičasta	12.000	
B-29066	125	22,23	najlon	crna	12.000	
B-36267	125	22,23	najlon	ljubičasta	12.000	
B-28999	180	22,23	fiberglas	crna	8.500	
B-29038	180	22,23	fiberglas	ljubičasta	8.500	
B-36239	180	22,23	najlon	crna	5.800	

Boja	Tip	Brzina	Vijek trajanja
	Standardni	100%	100%
	Produžen vijek trajanja	94%	130%



## X-LOCK brusni diskovi sa presovanim centrom za nerđajuće čelike

Postavljanje/uklanjanje bez korišćenja alata. Sprečava prejako pritezanje i labavost diskova. Odgovara svim X-LOCK ugaonim brusilicama i svim aktuelnim ugaonim brusilicama koje koriste navrtku za montiranje diska.



Model	Prečnik diska (Ø) (mm)	Debljina diska (mm)	Prihvata	Tip brusnog diska	Najveći broj obrtaja (min <sup>-1</sup> )	Opis	Cena sa PDV-om
E-00371	115	6	X-LOCK	WA36N	13.300	sa presovanim centrom	
E-00402	125	6	X-LOCK	WA36N	12.250	sa presovanim centrom	

- Akumulat orni i punjači
- Pribor za akumulat orske alate
- Akumulat orske lampe i pribor
- Pribor za laserske merace
- Pribor za rušenje i udarno bušenje
- Pribor za bušenje
- Krunaste testere
- Pribor za pritezanje
- Pribor za sečenje i brušenje
- Pribor za brušenje i poliranje
- Pribor za profilisanje i poravnanje
- Pribor za višenamenski alat
- Pribor za testere
- Pribor za pneumatike alate
- Pribor za fenove za vrući vazduh
- Pribor za usisivanje
- Pribor za alate za rad na otvoreno
- Pribor za držače alata i zaštitna
- Koferi i torbe
- Ručni alati
- Ostalo
- Pribor za mješanje



## FLEKSIBILNI BRUSNI DISKOVI

FLEKSIBILNA STRUKTURA OMOGUĆAVA BRUŠENJE DUGAČKIH POVRŠINA



VIBRATION  
60%  
DOWN  
Low  
VIBRATION

Idealne za  
aku. alate



Low  
VIBRATION

**BRUŠENJE**

**POLIRANJE**

**OBARANJE RUBOVA**

### PRAVAC MONTIRANJA I KORIŠĆENJE

\*Uvek da koristite podložni jastuk

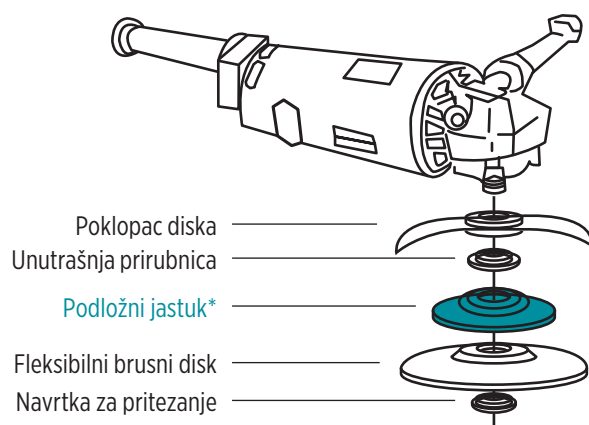

Radni ugao treba da se održava na 15 - 30°

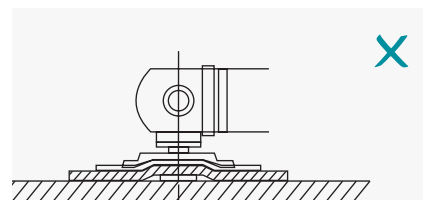
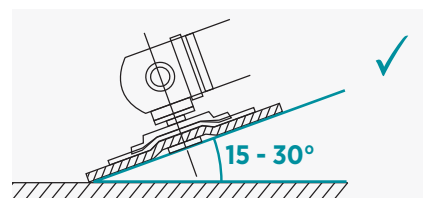

## Fleksibilni brusni diskovi

### Fleksibilne brusne ploče za nerđajući čelik - za akumulatorske ugaone brusilice

Ne zahteva upotrebu potporne podloge. Niže vibracije smanjuju zamor ruku zahvaljujući mikro ogrebotinama sa donje strane. Više rada s jednim punjenjem akumulatora.



Model	Prečnik brusnog diska (Ø) (mm)	Unutrašnji prečnik (Ø) (mm)	Debljina diska (mm)	Tip brusnog diska	Najveći broj obrtaja (min <sup>-1</sup> )	Cena sa PDV-om
B-53110	125	22,23	4	WA36P	12.250	

### Fleksibilni brusni diskovi za metal

Uvek koristiti podlogu. Manja buka. Niske vibracije. Isključivo primenljivi diskovi, jer se malo odbijaju od radne površine i nude odličnu obradu na velikim površinama. Široki spektar primene. Koriste se samo sa potporno podlogu za fleksibilne brusne diskove.



Model	Prečnik brusnog diska (Ø) (mm)	Unutrašnji prečnik (Ø) (mm)	Debljina diska (mm)	Tip brusnog diska	Najveći broj obrtaja (min <sup>-1</sup> )	Cena sa PDV-om
B-18275	115	22,23	3	AC36	13.300	
B-18281	115	22,23	3	AC46	13.300	
B-18297	115	22,23	3	AC60	13.300	
B-18306	115	22,23	3	AC80	13.300	

- Akumulatori i punjači
- Pribor za akumulatorske alate
- Akumulatorske lampe i pribor
- Pribor za laserske merace
- Pribor za rušenje i udarno bušenje
- Pribor za bušenje
- Krunaste testere
- Pribor za pritezanje
- Pribor za sečenje i brušenje
- Pribor za brušenje i poliranje
- Pribor za profilisanje i poravnavanje
- Pribor za višenamenski alat
- Pribor za testere
- Pribor za pneumatske alate
- Pribor za fenove za vrući vazduh
- Pribor za usisivanje
- Pribor za alate za rad na otvoreno
- Pribor za držače alata i zaštitna
- Koferi i torbe
- Ručni alati
- Ostalo
- Pribor za mješanje

# LAMELNI DISKOVI



## LAMELNI DISKOVI ZA INDUSTRIJSKU UPOTREBU



Viskoka efikasnost  
Duži vek trajanja

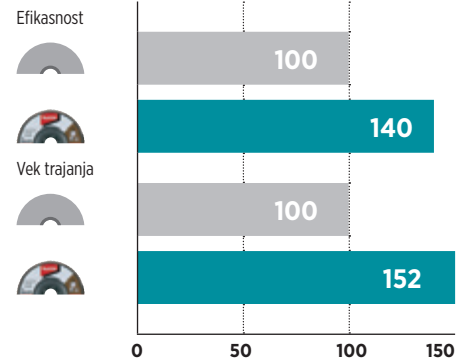

### TIP PODLOGE



Podloga od staklenih vlakana  
Standardni tip podloge



Podloga od najlona  
Za teške radne uslove

### OBLIK



Ravan  
Idealan za ravne površine



Iskošen  
Pogodan za uglove i čoškove

### GRAFIKON MATERIJALA

Vrsta abrazivnog materijala	A Aluminijum oksid	Z Aluminijum cirkonijum	C Silicijum karbid	Ce Keramički alu. oksid
Značenje boje nalepnice	Idealna za metal	Idealna za INOX i metal	Idealna za zidarske materijale	Idealna za INOX, metal i obojeni metal
Drvo	★			
Plastika, PVC	★			
Metali	★★	★★		★★
Obojeni metali	★	★		★★
Nerdžajući čelik		★		★★
Beton			★★	

★★: Preporučljivo ★: Prihvatljivo

## Lamelni diskovi



### Lamelne brusne ploče za industrijsku upotrebu

Lamelne brusne ploče za industrijsku upotrebu za ugaone brusilice.



Model	Prečnik brusnog diska (Ø) (mm)	Unutrašnji prečnik (Ø) (mm)	Granulacija	Opis	Najveći broj obrtaja (min <sup>-1</sup> )	Cena sa PDV-om
B-55603	115	22,23	Z40	ugaoni	13.300	
B-55619	115	22,23	Z60	ugaoni	13.300	
B-55625	115	22,23	Z80	ugaoni	13.300	
B-55631	115	22,23	Z120	ugaoni	13.300	
B-53920	125	22,23	Z40	ugaoni	12.200	
B-53936	125	22,23	Z60	ugaoni	12.200	
B-53942	125	22,23	Z80	ugaoni	12.200	
B-53958	125	22,23	Z120	ugaoni	12.200	
B-55647	180	22,23	Z40	ugaoni	8.600	
B-55653	180	22,23	Z60	ugaoni	8.500	
B-55669	180	22,23	Z80	ugaoni	8.500	
B-55675	180	22,23	Z120	ugaoni	8.500	

### Lamelni diskovi za nerđajuće čelike - cirkon aluminijum



Ravni lamelarni diskovi od cirkonijuma posebno su pogodni za teške poslove i zato su optimalni za grubo brušenje kao i za završno brušenje i poliranje tvrdih čelika. Brusni listovi se preklapaju u obliku ventilatora i montirani su na visoko kvalitetnom disku od staklenih vlakna. Glavne prednosti ovih lamelarnih diskova su: • brušenje sa niskom temperaturom • visoki kvalitet izbrušene površine • dugačak vek • nisko nivo buke Primena: • Uklanjanje korozije • Čišćenje odliivaka • Obaranje rubova • Poravnavanje • Uklanjanje korozije/kita • Završno brušenje



Model	Prečnik brusnog diska (Ø) (mm)	Unutrašnji prečnik (Ø) (mm)	Granulacija	Najveći broj obrtaja (min <sup>-1</sup> )	Cena sa PDV-om
D-63747	115	22,23	Z40	13.300	
D-63753	115	22,23	Z60	13.300	
D-63769	115	22,23	Z80	13.300	
D-63775	115	22,23	Z120	13.300	
P-65458	115	22,23	Z40	13.300	
P-65464	115	22,23	Z60	13.300	
P-65470	115	22,23	Z80	13.300	
P-65486	115	22,23	Z120	13.300	
B-22660	125	22,23	Z40	12.200	
B-22682	125	22,23	Z80	12.200	
B-22791	125	22,23	Z60	12.200	
B-22800	125	22,23	Z80	12.200	
B-22816	125	22,23	Z120	12.200	
D-63781	125	22,23	Z40	12.200	

[Nastavak...](#)

- Akumulat orni i punjači
- Pribor za akumulat orske alate
- Akumulat orske lampe i pribor
- Pribor za laserske merace
- Pribor za rušenje i udarno bušenje
- Pribor za bušenje
- Krunaste testere
- Pribor za pritzanije
- Pribor za sečenje i brušenje
- Pribor za brušenje i poliranje
- Pribor za profilisanje i poravnanje
- Pribor za višenamenski alat
- Pribor za testere
- Pribor za pneumatike alate
- Pribor za fenove za vrući vazduh
- Pribor za usisivanje
- Pribor za alate za rad na otvoreno
- Pribor za držače alata i zaštitna
- Koferi i torbe
- Ručni alati
- Ostalo
- Pribor za mješanje

# Pribor za sečenje i brušenje

Model	Prečnik brusnog diska (Ø) (mm)	Unutrašnji prečnik (Ø) (mm)	Granulacija	Najveći broj obrtaja (min <sup>-1</sup> )	Cena sa PDV-om
D-63797	125	22,23	Z60	12.250	
D-63806	125	22,23	Z80	12.250	
D-63812	125	22,23	Z120	12.250	
P-65492	125	22,23	Z40	12.250	
P-65501	125	22,23	Z60	12.000	
P-65517	125	22,23	Z80	12.000	
P-65523	125	22,23	Z120	12.000	
P-65539	150	22,23	Z40	10.200	
P-65545	150	22,23	Z60	10.200	
P-65551	150	22,23	Z80	10.200	
P-65567	150	22,23	Z120	10.200	
B-22707	180	22,23	Z40	8.500	
B-22713	180	22,23	Z60	8.500	
B-22729	180	22,23	Z80	8.500	
B-22735	180	22,23	Z120	8.500	
B-22822	180	22,23	Z40	8.500	
B-22838	180	22,23	Z60	8.500	
B-22844	180	22,23	Z80	8.500	
B-22850	180	22,23	Z120	8.500	
D-63828	180	22,23	Z40	8.500	
D-63834	180	22,23	Z60	8.500	
D-63840	180	22,23	Z80	8.500	
D-63856	180	22,23	Z120	8.500	
P-65573	180	22,23	Z40	8.600	
P-65589	180	22,23	Z60	8.600	
P-65595	180	22,23	Z80	8.600	
P-65604	180	22,23	Z120	8.600	

## Lamelni diskovi za čelik - aluminijum oksid



Abrazivni korund je posebno pogodan za mekane čelike. Ovi ravni lamelarni brusni diskovi su pogodni za grubo brušenje, kao i za završno brušenje i poliranje. Brusni listovi se preklapaju u obliku ventilatora i montirani su na visoko kvalitetnom disku od staklenih vlakna. Glavne prednosti ovih lamelarnih diskova su: • brušenje sa niskom temperaturom • visoki kvalitet izbrušene površine • dugačak vek • nisko nivo buke Primena: • Uklanjanje korozije • Čišćenje odlika • Obaranje rubova • Poravnjavanje • Uklanjanje korozije/kita • Završno brušenje



Model	Prečnik brusnog diska (Ø) (mm)	Unutrašnji prečnik (Ø) (mm)	Granulacija	Najveći broj obrtaja (min <sup>-1</sup> )	Cena sa PDV-om
D-63432	115	22,23	A40	13.300	
D-63448	115	22,23	A60	13.300	
D-63454	115	22,23	A80	13.300	
D-63460	115	22,23	A80	13.300	
P-65137	115	22,23	A40	13.300	
P-65143	115	22,23	A60	13.300	
P-65159	115	22,23	A80	13.300	
P-65165	115	22,23	A120	13.300	
D-63476	125	22,23	A40	12.250	
D-63482	125	22,23	A60	12.250	
D-63498	125	22,23	A80	12.250	
D-63507	125	22,23	A120	12.250	
P-65171	125	22,23	A40	12.000	

Nastavak...



# Pribor za sečenje i brušenje

Model	Prečnik brusnog diska (Ø) (mm)	Unutrašnji prečnik (Ø) (mm)	Granulacija	Najveći broj obrtaja (min <sup>-1</sup> )	Cena sa PDV-om
P-65187	125	22,23	A60	12.000	
P-65193	125	22,23	A80	12.000	
P-65202	125	22,23	A120	12.000	
P-65224	150	22,23	A60	10.200	
D-63513	180	22,23	A40	8.500	
D-63529	180	22,23	A60	8.500	
D-63535	180	22,23	A80	8.500	
D-63541	180	22,23	A120	8.500	
P-65252	180	22,23	A40	8.600	
P-65268	180	22,23	A60	8.600	
P-65274	180	22,23	A80	8.600	
P-65280	180	22,23	A120	8.600	



## Lamelni abrazivni disk - keramički aluminijum oksid

Idealan za rad sa nerđajućim čelikom i metalom. Brusi efikasno kao i vareni abrazivni disk. Pogodan za uklanjanje teških naslaga na visokom pritisku i visokoj temperaturi. Podloga od staklenih vlakna je lagana, fleksibilna, tiha i predstavlja najpopularniji materijal za podlogu diskova. Primena: litanijum, niki i nerđajući čelik. Čelik velike otpornosti, fabrikacija, automobilizam, vazduhoplovstvo, skidanje rde i finalna obrada. Odluke: izrađen od keramičkog aluminijuma - vrhunskog abraziva za sofisticirane metale velike otpornosti. Idealan za nerđajuće metale i uklanjanje teških naslaga. Podloga od staklenih vlakna. Lamelni abrazivni disk izrađen od nove generacije materijala Zirconia Alumina. Vrh ponude lamelnarnih abrazivnih diskova.



Model	Prečnik brusnog diska (Ø) (mm)	Unutrašnji prečnik (Ø) (mm)	Granulacija	Opis	Cena sa PDV-om
D-28298	115	22,23	Ce40	ugaoni	
D-28307	115	22,23	Ce60	ugaoni	
D-28313	115	22,23	Ce80	ugaoni	
D-28329	115	22,23	Ce120	ugaoni	
D-28450	115	22,23	Ce40	ravni	
D-28466	115	22,23	Ce60	ravni	
D-28472	115	22,23	Ce80	ravni	
D-28488	115	22,23	Ce120	ravni	
D-28335	125	22,23	Ce40	ugaoni	
D-28341	125	22,23	Ce60	ugaoni	
D-28357	125	22,23	Ce80	ugaoni	
D-28363	125	22,23	Ce120	ugaoni	
D-28494	125	22,23	Ce40	ravni	
D-28503	125	22,23	Ce60	ravni	
D-28519	125	22,23	Ce80	ravni	
D-28525	125	22,23	Ce120	ravni	
D-28379	180	22,23	Ce40	ugaoni	
D-28385	180	22,23	Ce60	ugaoni	
D-28391	180	22,23	Ce80	ugaoni	
D-28400	180	22,23	Ce120	ugaoni	
D-28531	180	22,23	Ce40	ravni	
D-28547	180	22,23	Ce60	ravni	
D-28553	180	22,23	Ce80	ravni	
D-28569	180	22,23	Ce120	ravni	

- Akumulat orni punjači
- Pribor za akumulat orske alate
- Akumulat orske lampe i pribor
- Pribor za laserske merace
- Pribor za rušenje i udarno bušenje
- Pribor za bušenje
- Krunaste testere
- Pribor za pritezanje
- Pribor za sečenje i brušenje
- Pribor za brušenje i poliranje
- Pribor za profilisanje i poravnava
- Pribor za višenamenski alat
- Pribor za pneumatike alate
- Pribor za fenove za vrući vazduh
- Pribor za usisivanje
- Pribor za alate za rad na otvoreno
- Pribor za držače alata i zaštitna
- Koferi i torbe
- Ručni alati
- Ostalo
- Pribor za mješanje



## Lamelarni diskovi za završnu obradu - fiberglas



Model	Prečnik brusnog diska (Ø) (mm)	Unutrašnji prečnik (Ø) (mm)	Grubost diska	Opis	Najveći broj obrtaja (min <sup>-1</sup> )	Cena sa PDV-om
B-40755	115	22,23	gruba	ugaoni	12.000	
B-40761	115	22,23	srednje gruba	ugaoni	12.000	
B-40777	115	22,23	fina	ugaoni	12.000	
B-40783	115	22,23	super fina	ugaoni	12.000	
B-40799	125	22,23	gruba	ugaoni	12.000	
B-40808	125	22,23	srednje gruba	ugaoni	12.000	
B-40814	125	22,23	fina	ugaoni	12.000	
B-40820	125	22,23	super fina	ugaoni	12.000	
B-40836	180	22,23	gruba	ugaoni	8.500	
B-40842	180	22,23	srednje gruba	ugaoni	8.500	
B-40858	180	22,23	fina	ugaoni	8.500	
B-40864	180	22,23	super fina	ugaoni	8.500	
B-40917	115	22,23	gruba	ravni	12.000	
B-40923	115	22,23	srednje gruba	ravni	12.000	
B-40939	115	22,23	fina	ravni	12.000	
B-40945	115	22,23	super fina	ravni	12.000	
B-40951	125	22,23	gruba	ravni	12.000	
B-40967	125	22,23	srednje gruba	ravni	12.000	
B-40973	125	22,23	fina	ravni	12.000	
B-40989	125	22,23	super fina	ravni	12.000	
B-40995	180	22,23	gruba	ravni	8.500	
B-41006	180	22,23	srednje gruba	ravni	8.500	
B-41012	180	22,23	fina	ravni	8.500	
B-41028	180	22,23	super fina	ravni	8.500	

## ŽIČANE ČETKE ZA UGAONE BRUSILICE

### OBLIK

Lončasta



Efikasno za ravnu ili neravnu površinu.

**XLock**  
M14

Okrugla



Efikasno za rad na teško dostupnim mestima.

**XLock**  
M14

Konusna

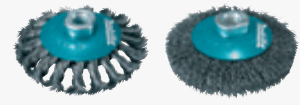

Idealno za obradu ivica i uglova.

**XLock**  
M14

### MATERIJAL ZA ČETKU

Čelik

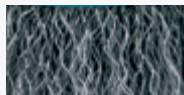

Idealno za uklanjanje korozije.

Čelik (mesingana presvlaka)

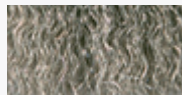

Idealno za obradu metala. Otporno na koroziju.

Nerdajući čelik

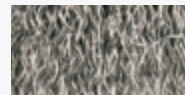

Idealno za obradu nerđajućeg čelika. Otporno na koroziju i visoke temperature.

### TIPOVI PLETENJA ŽICE

Presovana žica

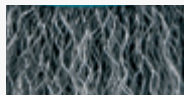

Idealno za uklanjanje korozije.

Upletena žica

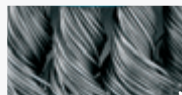

Idealno za teške poslove.



\*Dodati metalni prsten na dnu četke sprečava širenje čeličnih žica, obezbeđujući visoku efikasnost čak i uz konstantan težak rad.

## ŽIČANE I NAJLONSKE ČETKE ZA BUŠILICE

### OBLIK

Lončasta



Efikasno za ravnu ili neravnu površinu.



Okrugla



Primerna za ravne ili promenljive površine.



Četkica



Primerno za tesna i uska mesta.



Lepezasta

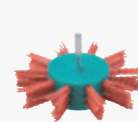

Primerno za obradu drveta.



### MATERIJAL ZA ČETKU

Čelik



Pletena

Idealan za obradu čelika.

vrlo gruba

★★

×

×

Čelik



Kovrdžava

Idealan za obradu čelika i za uklanjanje korozije.

Grubo

★★

×

×

Čelik (mesingana presvlaka)

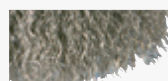

Kovrdžava

Idealan za obradu metala i drveta. Otporan na koroziju.

Grubo

★★

★

×

Najlonska gruba (#80)

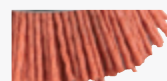

Kovrdžava

Idealno za uklanjanje korozije / boje, čišćenje i pripremu površina. Pogodno za metal, drvo i plastiku.

Fino

★★

★★

★★

Najlonska fina (#240)



Kovrdžava

Idealno za završnu obradu metala, drveta i plastike.

vrlo fina

★★

★★

★★

★★ Preporučeno ★ Odgovarajuće × Nemojte koristiti

## Žičane četke za brusilice



## Čelična žičana četka za brusilice - pletena žica

0,5 mm upletena čelična žica (Idealna za teške poslove za brzo čišćenje velikih površina). D-29290, D-24153: 0,5 mm dvostruko upletena čelična žica (Idealna za posebno teške radove. Dvostruko upletena čelična žica je upletena jače od standardnih).



Model	Prečnik četke (Ø) (mm)	Broj četkica	Prečnik žice (mm)	Najveći broj obrtaja (min <sup>-1</sup> )	Prihvata	Za model	Gena sa PDV-om
D-24119	60	16	0,5	12.500	M14	125, 150 mm ugaone brusilice	
D-24153	60	18	0,5	12.500	M14	125, 150 mm ugaone brusilice	
P-04488	65	18	0,5	12.500	M14	125, 150 mm ugaone brusilice	
D-24131	75	18	0,5	12.500	M14	125, 150 mm ugaone brusilice	
D-73330	80	18	0,5	12.500	X-LOCK	X-LOCK ugaone brusilice	
D-73374	80	18	0,35	12.500	X-LOCK	X-LOCK ugaone brusilice	
D-73380	80	18	0,5	12.500	X-LOCK	X-LOCK ugaone brusilice	
D-29290	100	26	0,5	8.500	M14	180, 230 mm ugaone brusilice	
P-04472	100	26	0,5	8.500	M14	180, 230 mm ugaone brusilice	



## Čelične žičane četke za brusilice - kovrdžava žica

0,3 mm kovrdžava čelična žica (idealna za uklanjanje lake korozije sa ravnih površina i rubova).



Model	Prečnik četke (Ø) (mm)	Prečnik žice (mm)	Najveći broj obrtaja (min <sup>-1</sup> )	Prihvata	Za model	Gena sa PDV-om
D-24072	60	0,3	12.500	M14	125, 150 mm ugaone brusilice	
D-24094	75	0,3	12.500	M14	125, 150 mm ugaone brusilice	
D-73346	75	0,3	12.500	X-LOCK	X-LOCK ugaone brusilice	
D-73396	75	0,3	12.500	X-LOCK	X-LOCK ugaone brusilice	
D-29284	100	0,3	8.500	M14	180, 230 mm ugaone brusilice	



## Čelične kružne žičane četke za brusilice - pletena žica

0,5 mm upletena čelična žica (efektivna za posebno teške radove na licu mesta).



Model	Prečnik četke (Ø) (mm)	Broj četkica	Prečnik žice (mm)	Najveći broj obrtaja (min <sup>-1</sup> )	Prihvatač	Za model	Cena sa PDV-om
D-29555	100	18	0,5	8.500	M14	125, 150, 180, 230 mm ugaone brusilice	
D-29561	115	20	0,5	8.500	M14	125, 150, 180, 230 mm ugaone brusilice	
D-73352	115	20	0,5	12.500	X-LOCK	X-LOCK ugaone brusilice	
D-73368	115	30	0,5	12.500	X-LOCK	X-LOCK ugaone brusilice	
D-73405	115	20	0,5	12.500	X-LOCK	X-LOCK ugaone brusilice	
D-73411	115	30	0,5	12.500	X-LOCK	X-LOCK ugaone brusilice	
D-29577	125	22	0,5	8.500	M14	125, 150, 180, 230 mm ugaone brusilice	



## Čelična konusna žičana četka za brusilice - pletena žica

0,5 mm upletena čelična žica (efektivna za rubove i čoškove).



Model	Prečnik četke (Ø) (mm)	Broj četkica	Prečnik žice (mm)	Najveći broj obrtaja (min <sup>-1</sup> )	Prihvatač	Za model	Cena sa PDV-om
D-39861	100	18	0,5	12.500	M14	125, 150, 180, 230 mm ugaone brusilice	
P-04494	100	18	0,5	12.500	M14	180, 230 mm ugaone brusilice	
D-39883	115	18	0,5	12.500	M14	125, 150, 180, 230 mm ugaone brusilice	

Akumulat  
ori i  
punjači

Pribor za  
akumulat  
orske  
alate

Akumulat  
orske  
lampe i  
pribor

Pribor za  
laserske  
merace

Pribor za  
rušenje i  
udarno  
bušenje

Pribor za  
bušenje

Krunaste  
testere

Pribor za  
pritzanji  
e

Pribor za  
sečenje i  
brušenje

Pribor za  
brušenje  
i  
poliranje

Pribor za  
profilisanje  
e i  
poravnav

Pribor za  
višenam  
enski alat

Pribor za  
testere

Pribor za  
pneumat  
ske alate

Pribor za  
fenove  
za vrući  
vazduh

Pribor za  
usisivanji  
e

Pribor za  
alate za  
rad na  
otvoreno

Pribor za  
držače  
alata i  
zaštitna

Koferi i  
torbe

Ručni  
alati

Ostalo

Pribor za  
mješanje



## Čelična konusna žičana četka za brusilice - kovrdžava žica

0,3 mm kovrdžava čelična žica (najbolja za bočno čišćenje).



Model	Prečnik četke (Ø) (mm)	Prečnik žice (mm)	Najveći broj obrtaja (min <sup>-1</sup> )	Prihvat	Za model	Cena sa PDV-om
D-39827	100	0,3	12.500	M14	125, 150, 180, 230 mm ugaone brusilice	
D-73449	100	0,3	12.500	X-LOCK	X-LOCK ugaone brusilice	
D-39849	115	0,3	12.500	M14	125, 150, 180, 230 mm ugaone brusilice	
D-73427	115	0,3	12.500	X-LOCK	X-LOCK ugaone brusilice	



## Čelična žičana četka za brusilice - kovrdžava žica

0,3 mm sa mesingom obložena čelična žica (idealna za uklanjanje lake korozije. Žica je zaštićena od korozije).



Model	Prečnik četke (Ø) (mm)	Prečnik žice (mm)	Najveći broj obrtaja (min <sup>-1</sup> )	Prihvat	Za model	Cena sa PDV-om
D-39746	60	0,3	12.500	M14	125, 150 mm ugaone brusilice	
D-39768	75	0,3	12.500	M14	125, 150 mm ugaone brusilice	
D-73433	75	0,3	12.500	X-LOCK	X-LOCK ugaone brusilice	
D-39780	90	0,3	8.500	M14	180, 230 mm ugaone brusilice	
D-39805	100	0,3	8.500	M14	180, 230 mm ugaone brusilice	

## Žičane četke za bušilice

### Čelična žičana četka za bušilice - pletena žica



Model	Prečnik četke (Ø) (mm)	Prečnik žice (mm)	Najveći broj obrtaja (min <sup>-1</sup> )	Prihvat	Cena sa PDV-om
D-73798	63	0,5	4.500	6 mm	
D-73807	75	0,5	4.500	6 mm	

### Čelične kružne žičane četke - pletena žica



Model	Prečnik četke (Ø) (mm)	Prečnik žice (mm)	Najveći broj obrtaja (min <sup>-1</sup> )	Prihvat	Cena sa PDV-om
D-73813	75	0,5	4.500	6 mm	
D-73829	100	0,5	4.500	6 mm	

### Čelična konusna žičana četka - pletena žica



Model	Prečnik četke (Ø) (mm)	Prečnik žice (mm)	Najveći broj obrtaja (min <sup>-1</sup> )	Prihvat	Cena sa PDV-om
D-73835	12	0,5	4.500	6 mm	
D-73841	19	0,5	4.500	6 mm	
D-73857	24	0,5	4.500	6 mm	
D-73863	28	0,5	4.500	6 mm	

Akumulat  
ori i  
punjači

Pribor za  
akumulat  
orske  
alate

Akumulat  
orske  
lampe i  
pribor

Pribor za  
laserske  
merace

Pribor za  
rušenje i  
udarno  
bušenje

Pribor za  
bušenje

Krunaste  
testere

Pribor za  
pritezanje

Pribor za  
sečenje i  
brušenje

Pribor za  
brušenje  
i  
poliranje

Pribor za  
profilisanje  
i  
poravnanje

Pribor za  
višenam  
enski alat

Pribor za  
testere

Pribor za  
pneumat  
ske alate

Pribor za  
fenove  
za vrući  
vazduh

Pribor za  
usisivanje

Pribor za  
alate za  
rad na  
otvoreno

Pribor za  
držače  
alata i  
zaštitna

Koferi i  
torbe

Ručni  
alati

Ostalo

Pribor za  
mješanje



### Žičana četka - za bušilice - kovrdžava žica

Pogodna za uklanjanje korozije, čišćenje šalovanih tabla, obaranje rubova i uklanjanje premaza i boja.



Model	Prečnik četke (Ø) (mm)	Prečnik žice (mm)	Najveći broj obrtaja (min <sup>-1</sup> )	Prihvata	Cena sa PDV-om
D-39908	38	0,3	4.500	6 mm	
D-39914	50	0,3	4.500	6 mm	
D-39920	63	0,3	4.500	6 mm	
D-39936	75	0,3	4.500	6 mm	
D-39942	80	0,3	4.500	6 mm	



### Žičane kružne četke - kovrdžava žica

Pogodna za uklanjanje korozije, čišćenje, uklanjanje premaza i boja u zatvorenom prostoru.



Model	Prečnik četke (Ø) (mm)	Prečnik žice (mm)	Najveći broj obrtaja (min <sup>-1</sup> )	Prihvata	Cena sa PDV-om
D-39958	38	0,3	4.500	6 mm	
D-39964	50	0,3	4.500	6 mm	
D-39970	63	0,3	4.500	6 mm	
D-39986	75	0,3	4.500	6 mm	
D-39992	100	0,3	4.500	6 mm	



### Žičane vretenaste četke - kovrdžava žica

Pogodna za uklanjanje korozije, nervnina i ostataka, obaranje rubova i uklanjanje premaza i boja u zatvorenom prostoru.



Model	Prečnik četke (Ø) (mm)	Prečnik žice (mm)	Najveći broj obrtaja (min <sup>-1</sup> )	Prihvata	Cena sa PDV-om
D-40004	12	0,3	4.500	6 mm	
D-40010	19	0,3	4.500	6 mm	
D-40026	25	0,3	4.500	6 mm	
D-40032	30	0,3	4.500	6 mm	





## Kompleti

Model	Prečnik četke (Ø) (mm)	Prečnik žice (mm)	Najveći broj obrtaja (min <sup>-1</sup> )	Prihvat	Cena sa PDV-om
D-65729	63, 75, 75, 100	0,3	4.500	6 mm	



## Žičana četka - za bušilice - mesing, kovrdžava žica



Model	Prečnik četke (Ø) (mm)	Prečnik žice (mm)	Najveći broj obrtaja (min <sup>-1</sup> )	Prihvat	Cena sa PDV-om
D-73601	38	0,3	4.500	1/4"	
D-73617	50	0,3	4.500	1/4"	
D-73623	63	0,3	4.500	1/4"	
D-73639	75	0,3	4.500	1/4"	
D-73645	80	0,3	4.500	1/4"	



## Žičane kružne četke - mesing, kovrdžava žica



Model	Prečnik četke (Ø) (mm)	Prečnik žice (mm)	Najveći broj obrtaja (min <sup>-1</sup> )	Prihvat	Cena sa PDV-om
D-73651	38	0,3	4.500	1/4"	
D-73667	50	0,3	4.500	1/4"	
D-73673	63	0,3	4.500	1/4"	
D-73689	75	0,3	4.500	1/4"	
D-73695	100	0,3	4.500	1/4"	

 Akumulat  
ori i  
punjači

 Pribor za  
akumulat  
orske  
alate

 Akumulat  
orske  
lampe i  
pribor

 Pribor za  
laserske  
merace

 Pribor za  
rušenje i  
udarno  
bušenje

 Pribor za  
bušenje

 Krunaste  
testere

 Pribor za  
pritezanje

 Pribor za  
sečenje i  
brušenje

 Pribor za  
brušenje  
i  
poliranje

 Pribor za  
profilisanje  
i  
poravnane

 Pribor za  
višenam  
enski alat

 Pribor za  
testere

 Pribor za  
pneumat  
ske alate

 Pribor za  
fenove  
za vrući  
vazduh

 Pribor za  
usisivanje

 Pribor za  
alate za  
rad na  
otvoreno

 Pribor za  
držače  
alata i  
zaštitna

 Koferi i  
torbe

 Ručni  
alati

Ostalo

 Pribor za  
mješanje



## Žičane vretenaste četke - mesing, kovrdžava žica



Model	Prečnik četke (Ø) (mm)	Prečnik žice (mm)	Najveći broj obrtaja (min <sup>-1</sup> )	Prihvata	Cena sa PDV-om
D-73704	12	0,3	4.500	1/4"	
D-73710	19	0,3	4.500	1/4"	
D-73726	24	0,3	4.500	1/4"	
D-73732	28	0,3	4.500	1/4"	

## Najlonske četke za bušilice

### Tanjiraste najlonske četke za bušilice

Idealne za uklanjanje lake korozije i boja sa metala, drveta i PVC-a.













	Model	Prečnik Ø (mm)	Najveći broj obrtaja (min <sup>-1</sup> )	Granulacija	Prihvata (mm)	Tip četke	Cena sa PDV-om
	D-45509	50	4.500	80	6	gruba	
	D-45537	50	4.500	240	6	fina	
	D-45515	63	4.500	80	6	gruba	
	D-45543	63	4.500	240	6	fina	
	D-45521	75	4.500	80	6	gruba	
	D-45559	75	4.500	240	6	fina	

# Pribor za sečenje i brušenje

## Najlonske kružne četke

Idealne za uklanjanje lake korozije i boja sa metala, drveta i PVC-a.



Model	Prečnik Ø (mm)	Najveći broj obrtaja (min <sup>-1</sup> )	Granulacija	Prihvat (mm)	Tip četke	Cena sa PDV-om	
D-45565	38	4.500	80	6	gruba		
D-45618	38	4.500	240	6	fina		
D-45571	50	4.500	80	6	gruba		
D-45624	50	4.500	240	6	fina		
D-45587	63	4.500	80	6	gruba		
D-45630	63	4.500	240	6	fina		
D-45593	75	4.500	80	6	gruba		
D-45646	75	4.500	240	6	fina		
D-45602	100	4.500	80	6	gruba		
D-45652	100	4.500	240	6	fina		



- Akumulat orni i punjači
- Pribor za akumulat orske alate
- Akumulat orske lampe i pribor
- Pribor za laserske merace
- Pribor za rušenje i udarno bušenje
- Pribor za bušenje
- Krunaste testere
- Pribor za pritezanje
- Pribor za sečenje i brušenje
- Pribor za brušenje i poliranje
- Pribor za profilisanje i poravnanje
- Pribor za višenamenski alat
- Pribor za testere
- Pribor za pneumatike alate
- Pribor za fenove za vrući vazduh
- Pribor za usisivanje
- Pribor za alate za rad na otvoreno
- Pribor za držače alata i zaštitna
- Koferi i torbe
- Ručni alati
- Ostalo
- Pribor za mješanje

# Pribor za sečenje i brušenje

## Najlonske lamelarne četke

Idealne za uklanjanje lake korozije i boja sa metala, drveta i PVC-a.











	Model	Prečnik Ø (mm)	Najveći broj obrtaja (min <sup>-1</sup> )	Granulacija	Prihvata (mm)	Tip četke	Cena sa PDV-om
	D-45749	100	4.500	80	6	gruba	
	D-45755	100	4.500	240	6	fina	

## Najlonske vretenaste četke

Idealne za uklanjanje lake korozije i boja sa metala, drveta i PVC-a.



	Model	Prečnik Ø (mm)	Najveći broj obrtaja (min <sup>-1</sup> )	Granulacija	Prihvata (mm)	Tip četke	Cena sa PDV-om
	D-45668	12	4.500	80	6	gruba	
	D-45705	12	4.500	240	6	fina	
	D-45711	17	4.500	240	6	fina	
	D-45674	19	4.500	80	6	gruba	
	D-45680	24	4.500	80	6	gruba	
	D-45727	24	4.500	240	6	fina	
	D-45696	30	4.500	80	6	gruba	
	D-45733	30	4.500	240	6	fina	

# Pribor za sečenje i brušenje

173



## Kompleti

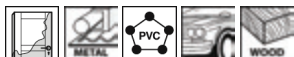

Model	Prečnik Ø (mm)	Najveći broj obrtaja (min <sup>-1</sup> )	Granulacija	Prihvat (mm)	Tip četke	Cena sa PDV-om
D-70758	24, 50, 50	4.500	240	6	gruba	

## Ostali pribor za ugaone brusilice

### Prirubnice

Model	Naziv	Za model	Cena sa PDV-om	
192227-7	Super prirubnica	Ø 115-230 mm		
195354-9	Ezy-navrtka prirubna navrtka	Ø 180/230 mm		
196297-8	Super navrtka	Ø 115/230 mm		
198678-2	Unutrašnja prirubnica	Ø 230 mm		
224415-9	Unutrašnja prirubnica	Ø 115-230 mm		
224543-0	Navrtka sa prirubnicom	Ø 180/230 mm		
224554-5	Navrtka sa prirubnicom	Ø 115/125/150 mm		

Akumulat  
ori i  
punjači

Pribor za  
akumulat  
orske  
alate

Akumulat  
orske  
lampe i  
pribor

Pribor za  
laserske  
merace

Pribor za  
rušenje i  
udarno  
bušenje

Pribor za  
bušenje

Krunaste  
testere

Pribor za  
pritezanj  
e

Pribor za  
sečenje i  
brušenje

Pribor za  
brušenje  
i  
poliranje

Pribor za  
profilisanj  
e i  
poravnaj

Pribor za  
višenam  
enski alat

Pribor za  
testere

Pribor za  
pneumat  
ske alate

Pribor za  
fenove  
za vrući  
vazduh

Pribor za  
usisivanj  
e

Pribor za  
alate za  
rad na  
otvoreno

Pribor za  
držače  
alata i  
zaštitna

Koferi i  
torbe













Ručni  
alati

Ostalo

Pribor za  
mješanje

# Pribor za sečenje i brušenje

## Poklopac za prašinu kompleti

	Model	Naziv	Za model	Pogodno za	Gena sa PDV-om
	199709-0	Uklonjivi poklopac za rezanje 115mm	/	115 mm ugaone brusilice	
	192968-5	Usisni štitić za ugaonu brusilicu sa spojnicom	/	115/125 mm ugaone brusilice	
	192972-4	Usisni štitić za ugaonu brusilicu bez spojnice	/	115/125 mm ugaone brusilice	
	193794-5	Sakupljač prašine za brusni disk	/	115/125 mm ugaone brusilice	
	195239-9	Sakupljač prašine za brusni disk	/	115/125 mm ugaone brusilice	
	196845-3	Sakupljač prašine za brusni disk	/	115/125 mm ugaone brusilice	
	451765-1	Prednji poklopac štitić za brušenje betona za 195239-9	/	115/125 mm ugaone brusilice	
	199710-5	Uklonjivi poklopac za rezanje 125mm	/	125 mm ugaone brusilice	
	198514-2	Štitić sa sistemom za sakupljanje prašine	/	180 mm ugaone brusilice	
	194044-1	Sakupljač prašine za brusni disk	/	180/230 mm ugaone brusilice	
	195385-8	Sakupljač prašine za brusni disk	/	180/230 mm ugaone brusilice	
	452086-4	Prednji poklopac štitić za brušenje betona za 195385-8	/	180/230 mm ugaone brusilice	
	198440-5	Štitić sa sistemom za sakupljanje prašine	/	230 mm ugaone brusilice	
	743332-9	Četka (duga) za usisni štitić 195239-9	191F81-2, 195239-9	115/125 mm ugaone brusilice	

[Nastavak...](#)

# Pribor za sečenje i brušenje

175

Model	Naziv	Za model	Pogodno za	Cena sa PDV-om	
743333-7	Četka (kratka) za usisni štitićnik 195239-9	191F81-2, 195239-9	115/125 mm ugaone brusilice		
743334-5	Četka (duga) za usisni štitićnik 195385-8	195385-8	180/230 mm ugaone brusilice		
743335-3	Četka (kratka) za usisni štitićnik 195385-8	195385-8	180/230 mm ugaone brusilice		
192188-1	Sakupljač prašine za brusni disk	9005B, 9005N	/		
193903-6	Poklopac za prašinu	9564H, 9565H, 9565CR, 9565CLR, 9566CVR, GA5080R	/		
122910-2	Štitićnik	DGA450, DGA452, GA4530/R, GA4540/C/R, GA4541C/R	/		
162708-5	Štitićnik	DGA519, DGA520, DGA521	125 mm ugaone brusilice		
191G05-4	Sakupljač prašine za brusni disk X-LOCK	DGA519, DGA520, DGA521	125 mm ugaone brusilice		
457620-5	Poklopac za prašinu	DGA900/DGA700	/		
162557-0	Zaštitni poklopac	GA005G, GA008G, GA023G, GA029G, GA5050R	/		
191F81-2	Komplet poklopca za odvođenje prašine XGT	GA005G, GA008G, GA023G, GA029G, GA5050R	/		
191G06-2	Komplet poklopca za odvođenje prašine XGT	GA005G, GA008G, GA023G, GA029G, GA5050R	/		
347480-2	Štitićnik	GA005G, GA008G, GA023G, GA029G, GA5050R, GA5051R	125 mm ugaone brusilice		
198719-4	Poklopac za prašinu	GA4540C, GA4540R, GA5040C	/		
347479-7	Štitićnik	GA4550R	115 mm ugaone brusilice		

Nastavak...

Akumulat  
ori i  
punjači

Pribor za  
akumulat  
orske  
alate

Akumulat  
orske  
lampe i  
pribor

Pribor za  
laserske  
merace

Pribor za  
rušenje i  
udarno  
bušenje

Pribor za  
bušenje

Krunaste  
testere

Pribor za  
pritezani  
e

Pribor za  
sečenje i  
brušenje

Pribor za  
brušenje  
i  
poliranje

Pribor za  
profilisanj  
e i  
poravnaj

Pribor za  
višenam  
enski alat

Pribor za  
testere

Pribor za  
pneumat  
ske alate

Pribor za  
fenove  
za vrući  
vazduh

Pribor za  
usisivanj  
e

Pribor za  
alate za  
rad na  
otvoreno

Pribor za  
držaće  
alata i  
zaštitna







Koferi i  
torbe

Ručni  
alati

Ostalo



Pribor za  
mješanje

## Pribor za sečenje i brušenje

	Model	Naziv	Za model	Pogodno za	Cena sa PDV-om
	199514-5	Poklopac za prašinu	GA5050R, GA5051R	/	
	122914-4	Štitnik	GA7010C, GA7020/F/RF, GA7030RF01, GA7040RF01, GA7060R, GA7061R	/	
	194289-1	Poklopac za prašinu	GA7020, GA7030, GA7030S, GA7040S, GA9020, GA9030, GA9030S, GA9040S	/	
	191T15-9	Poklopac za prašinu	GA7070, GA9070, GA9071	/	
	122913-6	Štitnik	GA9010C, GA9020/F/RF/RFK, GA9030/R/RF, GA9040R/RF, GA9050/R, GA9060R, GA9061R	/	
	195059-1	Poklopac za prašinu	GA9050, GA9050R	/	

## Pribor za grickalice i rezače za lim

















### Noževi za makaze i pribor za grickalice za lim

	Model	Naziv	Za model	Jedinica (kom/kompl)	Cena sa PDV-om
	191383-0	Komplet noževa za makaze	JS1600, JS1602	2/1	
	725092-5	Oštrica desna	DJS200	1	
	725093-3	Oštrica leva	DJS200	1	
	725255-3	Oštrica srednja	DJS200	1	
	725256-1	Oštrica desna	DJS131	1	
	725257-9	Oštrica srednja	DJS131	1	
	725258-7	Oštrica leva	DJS131	1	

[Nastavak...](#)

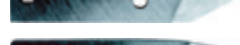
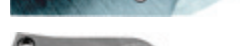

# Pribor za sečenje i brušenje

Model	Naziv	Za model	Jedinica (kom/kompl)	Cena sa PDV-om	
762007-1	Kontrolnik za debljinu, 1-1.5-2 mm	JS3200, JS3201	1		
762013-6	Kontrolnik za debljinu, 0.5-1.5-2 mm	JS1660, JS1601, DJS161	1		
792264-7	Matrica	JN1600	1		
792265-5	Probijač	JN1600	1		
792287-5	Nož za makaze	JS3200, JS3201	2/1		
792292-2	Matrica	JN3200	1		
792367-7	Srednji nož	JS1650	1		
792368-5	Bočni nož, komplet za	JS1650	1		
792533-6	Komplet bočnih noževa	DJS160, DJS161, JS1660, JS1601	2/1		
792534-4	Srednji nož	JS1660, JS1601, DJS161	1		
792536-0	Komplet bočnih noževa	DJS100, DJS101, JS1670, BJS101RFE, JS1000	2/1		
792537-8	Srednji nož	JS1670, BJS101RFE, JS1000	1		
792728-1	Probijač	JN3200, JN3201	1		
792742-7	Nož za rezanje u desno	DJS130, JS1300	1		
792743-5	Nož za rezanje u levo	DJS130, JS1300	1		
792744-3	Nož za ravno rezanje	DJS130, JS1300	1		
A-15051	Matrica	JN1601, DJN161	1		
A-83951	Probijač	JN1601, DJN161	1		

Akumulat  
ori i  
punjači

Pribor za  
akumulat  
orske  
alate

Akumulat  
orske  
lampe i  
pribor

Pribor za  
laserske  
merace

Pribor za  
rušenje i  
udarno  
bušenje

Pribor za  
bušenje

Krunaste  
testere

Pribor za  
pritezani  
e

Pribor za  
sečenje i  
brušenje

Pribor za  
brušenje  
i  
poliranje

Pribor za  
profilisanj  
e i  
poravnaj

Pribor za  
višenam  
enski alat

Pribor za  
testere

Pribor za  
pneumat  
ske alate

Pribor za  
fenove  
za vrući  
vazduh

Pribor za  
usisivanj  
e

Pribor za  
alate za  
rad na  
otvoreno

Pribor za  
držače  
alata i  
zaštitna

Koferi i  
torbe

Ručni  
alati

Ostalo

Pribor za  
mješanje

# PRIBOR ZA BRUŠENJE I POLIRANJE

Prirodni kamen



Malter



Metali



Aluminijum



Nerđajući čelik



Obojeni metali



Staklo



Plastika, PVC



Drvo sa ekserima



Drvo



Meko drvo



Uklanjanje boja



Završni rad



Obojene i lakirane površine



Lepljenje sa čičkom



Aluminijum oksid

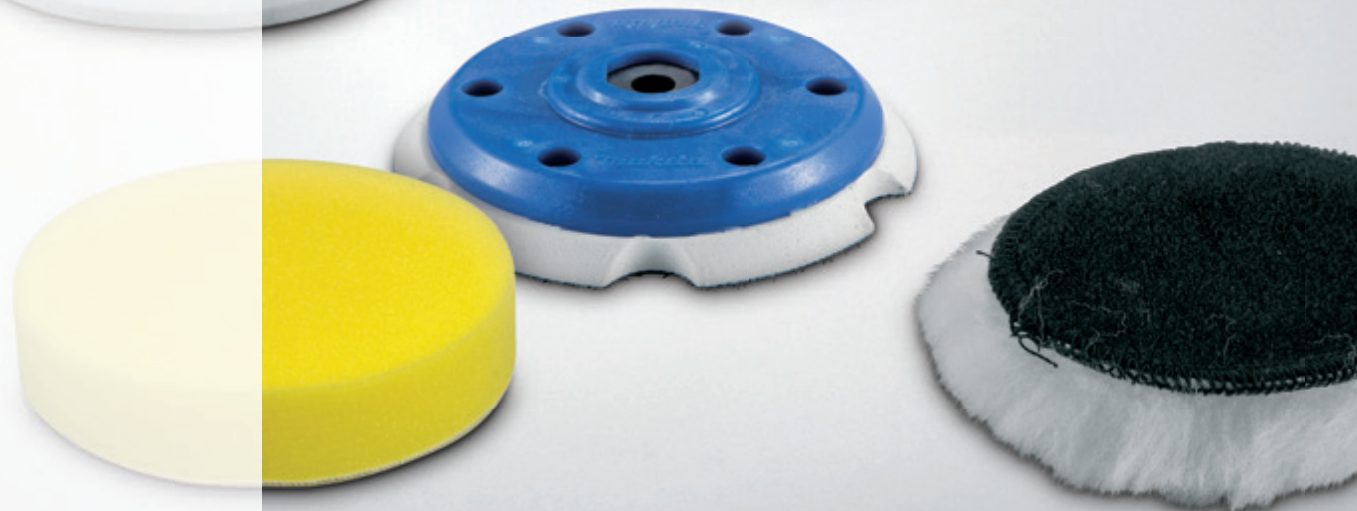

# Pribor za brušenje i poliranje

## Tračne brusilice

### Brusna traka

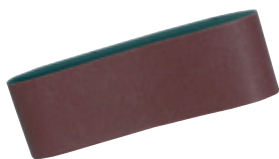
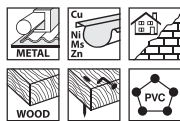

Model	Dimenzija	Granulacija	Jedinica (Kom/kompl)
P-37091	76 × 457 mm	40	5/1
P-37100	76 × 457 mm	60	5/1
P-37116	76 × 457 mm	80	5/1
P-37122	76 × 457 mm	100	5/1
P-37138	76 × 457 mm	120	5/1
P-37144	76 × 457 mm	150	5/1
P-37150	76 × 457 mm	240	5/1
P-37166	76 × 457 mm	60/80/120	3/1
P-37172	76 × 533 mm	40	5/1
P-37247	76 × 533 mm	40	25/1
P-43393	76 × 533 mm	40	50/1
P-37188	76 × 533 mm	60	5/1
P-37253	76 × 533 mm	60	25/1
P-43402	76 × 533 mm	60	50/1
P-37194	76 × 533 mm	80	5/1
P-37269	76 × 533 mm	80	25/1
P-43418	76 × 533 mm	80	50/1
P-37203	76 × 533 mm	100	5/1
P-37275	76 × 533 mm	100	25/1
P-43424	76 × 533 mm	100	50/1
P-37219	76 × 533 mm	120	5/1
P-37281	76 × 533 mm	120	25/1
P-43430	76 × 533 mm	120	50/1
P-37225	76 × 533 mm	150	5/1
P-37297	76 × 533 mm	150	25/1
P-43446	76 × 533 mm	150	50/1
P-37231	76 × 533 mm	240	5/1
P-37306	76 × 533 mm	240	25/1
P-43452	76 × 533 mm	240	50/1
P-37312	76 × 610 mm	40	5/1
P-51144	76 × 610 mm	40	25/1
P-37328	76 × 610 mm	60	5/1
P-51150	76 × 610 mm	60	25/1
P-37334	76 × 610 mm	80	5/1
P-51164	76 × 610 mm	80	25/1
P-37340	76 × 610 mm	100	5/1
P-51172	76 × 610 mm	100	25/1
P-37356	76 × 610 mm	120	5/1
P-51188	76 × 610 mm	120	25/1
P-37362	76 × 610 mm	150	5/1
P-51194	76 × 610 mm	150	25/1
P-37378	76 × 610 mm	240	5/1
P-51203	76 × 610 mm	240	25/1
P-36740	100 × 560 mm	40	5/1
P-36756	100 × 560 mm	60	5/1
P-36762	100 × 560 mm	80	5/1
P-36837	100 × 560 mm	80	25/1
P-36778	100 × 560 mm	100	5/1
P-36784	100 × 560 mm	120	5/1
P-36859	100 × 560 mm	120	25/1
P-36790	100 × 560 mm	150	5/1

P-36809	100 × 560 mm	240	5/1
P-36887	100 × 610 mm	40	5/1
P-36952	100 × 610 mm	40	25/1
P-36893	100 × 610 mm	60	5/1
P-36968	100 × 610 mm	60	25/1
P-36902	100 × 610 mm	80	5/1
P-36974	100 × 610 mm	80	25/1
P-36918	100 × 610 mm	100	5/1
P-36980	100 × 610 mm	100	25/1
P-43496	100 × 610 mm	100	50/1
P-36924	100 × 610 mm	120	5/1
P-36996	100 × 610 mm	120	25/1
P-36930	100 × 610 mm	150	5/1
P-37007	100 × 610 mm	150	25/1
P-43511	100 × 610 mm	150	50/1
P-36946	100 × 610 mm	240	5/1
P-37013	100 × 610 mm	240	25/1
P-43527	100 × 610 mm	240	50/1
P-37029	100 × 620 mm	40	5/1
P-37035	100 × 620 mm	60	5/1
P-37041	100 × 620 mm	80	5/1
P-37057	100 × 620 mm	100	5/1
P-37063	100 × 620 mm	120	5/1
P-37079	100 × 620 mm	150	5/1
P-43181	6 × 533 mm	40	5/1
P-43197	6 × 533 mm	60	5/1
P-43206	6 × 533 mm	80	5/1
P-43212	6 × 533 mm	100	5/1
P-43228	6 × 533 mm	120	5/1
P-43234	6 × 533 mm	150	5/1
P-43240	6 × 533 mm	240	5/1
P-43256	9 × 533 mm	40	5/1
P-43262	9 × 533 mm	60	5/1
P-43278	9 × 533 mm	80	5/1
P-43284	9 × 533 mm	100	5/1
P-43290	9 × 533 mm	120	5/1
P-43321	13 × 533 mm	40	5/1
P-43337	13 × 533 mm	60	5/1
P-43343	13 × 533 mm	80	5/1
P-43359	13 × 533 mm	100	5/1
P-43365	13 × 533 mm	120	5/1
P-43371	13 × 533 mm	150	5/1
P-43387	13 × 533 mm	240	5/1
P-36675	30 × 533 mm	40	5/1
A-23852	30 × 533 mm	40	10/1
P-36681	30 × 533 mm	60	5/1
A-23868	30 × 533 mm	60	10/1
P-36697	30 × 533 mm	80	5/1
A-23874	30 × 533 mm	80	10/1
P-36706	30 × 533 mm	100	5/1
A-23880	30 × 533 mm	100	10/1
P-36712	30 × 533 mm	120	5/1
A-23896	30 × 533 mm	120	10/1
P-36728	30 × 533 mm	150	5/1
P-36734	30 × 533 mm	240	5/1

- Akumulat orni i punjači
- Pribor za akumulat orske alat
- Akumulat orske lampe i pribor
- Pribor za laserske merace
- Pribor za rušenje i udarno bušenje
- Pribor za bušenje
- Krunaste testere
- Pribor za pritezanje
- Pribor za sečenje i brušenje
- Pribor za brušenje i poliranje
- Pribor za profilisanje i poravnavanje
- Pribor za višenamenski alat
- Pribor za testere
- Pribor za pneumatske alat
- Pribor za fenove i vazduh
- Pribor za usisavanje
- Pribor za alat za rad na otvoreno
- Pribor za držače alata i zaštitna
- Koferi i torbe
- Ručni alat
- Ostalo
- Pribor za mješanje

## Brusna traka za staklo



Model	Dimenzija	Granulacija	Jedinica (Kom/kompl)
P-01395	30 × 533 mm	40	5/1
P-01404	30 × 533 mm	60	5/1
P-01199	30 × 533 mm	80	5/1
P-01208	30 × 533 mm	100	5/1
P-01214	30 × 533 mm	120	5/1
P-01236	30 × 533 mm	180	5/1

## Ekscentrične brusilice za šmirglanje

### Brusna hartija - 8 rupa

Pričvršćivanje s čičkom.

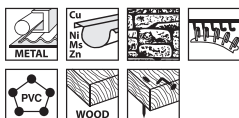

Model	Prečnik	Granulacija	Jedinica (Kom/kompl)
P-43533	125 mm	40	10/1
P-43620	125 mm	40	50/1
P-43549	125 mm	60	10/1
P-43636	125 mm	60	50/1
P-43555	125 mm	80	10/1
P-43642	125 mm	80	50/1
P-43561	125 mm	100	10/1
P-43658	125 mm	100	50/1
P-43577	125 mm	120	10/1
P-43664	125 mm	120	50/1
P-43583	125 mm	180	10/1
P-43670	125 mm	180	50/1
P-43599	125 mm	240	10/1
P-43686	125 mm	240	50/1
P-43608	125 mm	320	10/1
P-43692	125 mm	320	50/1
P-43614	125 mm	400	10/1

Pričvršćivanje s čičkom.

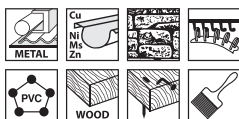

Model	Prečnik	Granulacija	Jedinica (Kom/kompl)
P-33342	125 mm	40	10/1
P-37384	125 mm	40	50/1
P-33358	125 mm	60	10/1
P-37390	125 mm	60	50/1

P-33364	125 mm	80	10/1
P-37409	125 mm	80	50/1
P-33370	125 mm	100	10/1
P-33386	125 mm	120	10/1
P-37421	125 mm	120	50/1
P-33392	125 mm	180	10/1
P-33401	125 mm	240	10/1
P-33417	125 mm	320	10/1
P-33423	125 mm	400	10/1
P-37465	125 mm	400	50/1

Pričvršćivanje s čičkom.

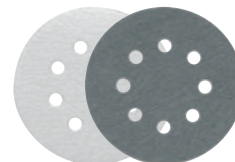
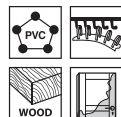

Model	Prečnik	Granulacija	Jedinica (Kom/kompl)
D-65816	125 mm	40	10/1
D-65822	125 mm	60	10/1
D-65838	125 mm	80	10/1
D-65844	125 mm	100	10/1
D-65850	125 mm	120	10/1
D-65866	125 mm	150	10/1
D-65872	125 mm	180	10/1
D-65888	125 mm	240	10/1
D-65894	125 mm	320	10/1
D-65903	125 mm	400	10/1

### Brusna hartija - 6 rupa

Pričvršćivanje s čičkom.



Model	Prečnik	Granulacija	Jedinica (Kom/kompl)
P-37471	150 mm	40	10/1
P-37568	150 mm	40	50/1
P-37487	150 mm	60	10/1
P-37574	150 mm	60	50/1
P-37493	150 mm	80	10/1
P-37580	150 mm	80	50/1
P-37502	150 mm	100	10/1
P-37596	150 mm	100	50/1
P-37518	150 mm	120	10/1
P-37605	150 mm	120	50/1
P-37524	150 mm	180	10/1
P-37611	150 mm	180	50/1
P-37530	150 mm	240	10/1
P-37627	150 mm	240	50/1
P-37546	150 mm	320	10/1
P-37633	150 mm	320	50/1
P-37552	150 mm	400	10/1
P-37649	150 mm	400	50/1

Akumulat orni punjači  
 Pribor za akumulat orske alate  
 Akumulat orske lampe i pribor  
 Pribor za laserske merace  
 Pribor za rušenje i udarno bušenje  
 Pribor za bušenje  
 Krunaste testere  
 Pribor za pritizanje  
 Pribor za sečenje i brušenje  
 Pribor za brušenje i poliranje  
 Pribor za profilisanje i poravnavanje  
 Pribor za višenamenski alat  
 Pribor za testere  
 Pribor za pneumatske alate  
 Pribor za fenove za vrući vazduh  
 Pribor za usisivanje  
 Pribor za alate za rad na otvoreno  
 Pribor za držače alata i zaštitna  
 Koferi i torbe  
 Ručni alati  
 Ostalo  
 Pribor za mješanje

# Pribor za brušenje i poliranje

Pričvršćivanje s čičkom.

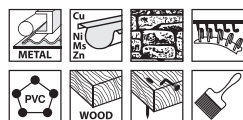

Model	Prečnik	Granulacija	Jedinica (Kom/kompl)
P-37655	150 mm	40	10/1
P-37742	150 mm	40	50/1
P-37661	150 mm	60	10/1
P-37758	150 mm	60	50/1
P-37677	150 mm	80	10/1
P-37764	150 mm	80	50/1
P-37683	150 mm	100	10/1
P-37770	150 mm	100	50/1
P-37699	150 mm	120	10/1
P-37786	150 mm	120	50/1
P-37708	150 mm	180	10/1
P-37792	150 mm	180	50/1
P-37714	150 mm	240	10/1
P-37801	150 mm	240	50/1
P-37720	150 mm	320	10/1
P-37817	150 mm	320	50/1
P-37736	150 mm	400	10/1
P-37823	150 mm	400	50/1

Pričvršćivanje s čičkom.

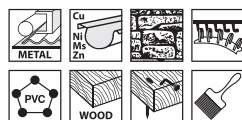

Model	Prečnik	Granulacija	Jedinica (Kom/kompl)
P-37839	150 mm	40	10/1
P-37948	150 mm	40	50/1
P-37845	150 mm	60	10/1
P-37851	150 mm	80	10/1
P-37960	150 mm	80	50/1
P-37867	150 mm	100	10/1
P-37976	150 mm	100	50/1
P-37873	150 mm	120	10/1
P-37982	150 mm	120	50/1
P-37889	150 mm	150	10/1
P-37895	150 mm	180	10/1
P-37998	150 mm	180	50/1
P-37910	150 mm	240	10/1
P-38009	150 mm	240	50/1
P-37926	150 mm	320	10/1
P-38015	150 mm	320	50/1
P-37932	150 mm	400	10/1
P-38021	150 mm	400	50/1

## Brusna hartija - 9 rupa

Pričvršćivanje s čičkom.

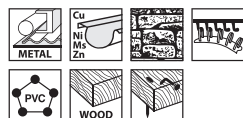

Model	Prečnik	Granulacija	Jedinica (Kom/kompl)
P-31918	150 mm	40	10/1
P-32574	150 mm	40	50/1
P-31924	150 mm	60	10/1
P-32580	150 mm	60	50/1
P-31930	150 mm	80	10/1
P-32596	150 mm	80	50/1
P-31946	150 mm	100	10/1
P-32605	150 mm	100	50/1
P-31952	150 mm	120	10/1
P-32611	150 mm	120	50/1
P-31968	150 mm	150	10/1
P-31974	150 mm	180	10/1
P-32633	150 mm	180	50/1
P-31980	150 mm	220	10/1
P-31996	150 mm	240	10/1
P-32655	150 mm	240	50/1
P-32007	150 mm	320	10/1
P-32661	150 mm	320	50/1
P-32013	150 mm	400	10/1
P-32677	150 mm	400	50/1

## Oscilatorne/brusilice za završnu obradu

### Brusna hartija

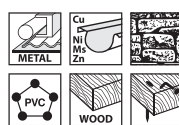

Model	Dimenzija	Granulacija	Jedinica (Kom/kompl)
P-36398	140 x 114 mm	40	10/1
P-32904	140 x 114 mm	60	10/1
P-36441	140 x 114 mm	60	50/1
P-36407	140 x 114 mm	80	10/1
P-32910	140 x 114 mm	100	10/1
P-36463	140 x 114 mm	100	50/1
P-32926	140 x 114 mm	120	10/1
P-36479	140 x 114 mm	120	50/1
P-32932	140 x 114 mm	150	10/1
P-36485	140 x 114 mm	150	50/1
P-36413	140 x 114 mm	180	10/1
P-36429	140 x 114 mm	240	10/1

- Akumulat orni i punjači
- Pribor za akumulat orske alate
- Akumulat orske lampe i pribor
- Pribor za laserske merace
- Pribor za rušenje i udarno bušenje
- Pribor za bušenje
- Krunaste testere
- Pribor za pritezanje
- Pribor za sečenje i brušenje
- Pribor za brušenje i poliranje
- Pribor za profilisanje i poravnavanje
- Pribor za višenamenski alat
- Pribor za testere
- Pribor za pneumatike alate
- Pribor za fenove za vrući vazduh
- Pribor za usisivanje
- Pribor za alate za rad na otvoreno
- Pribor za držače alata i zaštitna
- Koferi i torbe
- Ručni alati
- Ostalo
- Pribor za mješanje

# Pribor za brušenje i poliranje

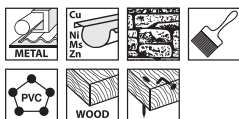

Model	Dimenzija	Granulacija	Jedinica (Kom/kompl)
P-36516	140 × 114 mm	40	10/1
P-36522	140 × 114 mm	60	10/1
P-36603	140 × 114 mm	60	50/1
P-36538	140 × 114 mm	80	10/1
P-36619	140 × 114 mm	80	50/1
P-36544	140 × 114 mm	100	10/1
P-36625	140 × 114 mm	100	50/1
P-36550	140 × 114 mm	120	10/1
P-36566	140 × 114 mm	150	10/1
P-36647	140 × 114 mm	150	50/1
P-36572	140 × 114 mm	180	10/1
P-36588	140 × 114 mm	240	10/1
P-36669	140 × 114 mm	240	50/1

## Brusna hartija - 6 rupa

Pričvršćivanje s čičkom.

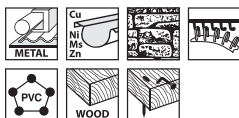

Model	Dimenzija	Granulacija	Jedinica (Kom/kompl)
P-33087	102 × 114 mm	40	10/1
P-33093	102 × 114 mm	60	10/1
P-33102	102 × 114 mm	80	10/1
P-33118	102 × 114 mm	100	10/1
P-33124	102 × 114 mm	120	10/1
P-33130	102 × 114 mm	150	10/1
P-33146	102 × 114 mm	180	10/1
P-33152	102 × 114 mm	240	10/1
P-33168	102 × 114 mm	320	10/1

Pričvršćivanje s čičkom.



Model	Dimenzija	Granulacija	Jedinica (Kom/kompl)
P-35807	102 × 114 mm	40	10/1
P-35813	102 × 114 mm	60	10/1
P-35829	102 × 114 mm	80	10/1
P-35835	102 × 114 mm	100	10/1
P-35841	102 × 114 mm	120	10/1
P-35857	102 × 114 mm	150	10/1
P-35863	102 × 114 mm	180	10/1
P-35879	102 × 114 mm	240	10/1
P-35885	102 × 114 mm	320	10/1

## Brusna hartija

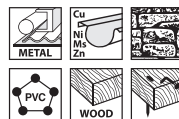

Model	Dimenzija	Granulacija	Jedinica (Kom/kompl)
P-36136	230 × 93 mm	40	10/1
P-36186	230 × 93 mm	40	50/1
P-32948	230 × 93 mm	60	10/1
P-36192	230 × 93 mm	60	50/1
P-36142	230 × 93 mm	80	10/1
P-36201	230 × 93 mm	80	50/1
P-32954	230 × 93 mm	100	10/1
P-36217	230 × 93 mm	100	50/1
P-36158	230 × 93 mm	120	10/1
P-36223	230 × 93 mm	120	50/1
P-36239	230 × 93 mm	150	50/1
P-36245	230 × 93 mm	180	50/1
P-36170	230 × 93 mm	240	10/1
P-36251	230 × 93 mm	240	50/1

## Brusna hartija - 8 rupa

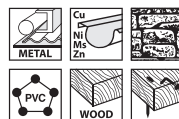

Model	Dimenzija	Granulacija	Jedinica (Kom/kompl)
P-31837	230 × 93 mm	40	10/1
P-36055	230 × 93 mm	40	50/1
P-31843	230 × 93 mm	60	10/1
P-36061	230 × 93 mm	60	50/1
P-31859	230 × 93 mm	80	10/1
P-36077	230 × 93 mm	80	50/1
P-31865	230 × 93 mm	100	10/1
P-36083	230 × 93 mm	100	50/1
P-36011	230 × 93 mm	120	10/1
P-36099	230 × 93 mm	120	50/1
P-36027	230 × 93 mm	150	10/1
P-36108	230 × 93 mm	150	50/1
P-36033	230 × 93 mm	180	10/1
P-36114	230 × 93 mm	180	50/1
P-36049	230 × 93 mm	240	10/1
P-36120	230 × 93 mm	240	50/1

# Pribor za brušenje i poliranje

Pričvršćivanje s čičkom.

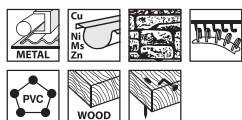

Model	Dimenzija	Granulacija	Jedinica (Kom/kompl)
P-31871	185 x 93 mm	40	10/1
P-35938	185 x 93 mm	40	50/1
P-31887	185 x 93 mm	60	10/1
P-35944	185 x 93 mm	60	50/1
P-31893	185 x 93 mm	80	10/1
P-31902	185 x 93 mm	100	10/1
P-35966	185 x 93 mm	100	50/1
P-35891	185 x 93 mm	120	10/1
P-35972	185 x 93 mm	120	50/1
P-35900	185 x 93 mm	150	10/1
P-35988	185 x 93 mm	150	50/1
P-35916	185 x 93 mm	180	10/1
P-35994	185 x 93 mm	180	50/1
P-35922	185 x 93 mm	240	10/1
P-36005	185 x 93 mm	240	50/1

## Brusna hartija

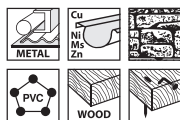

Model	Dimenzija	Granulacija	Jedinica (Kom/kompl)
P-36267	280 x 115 mm	40	10/1
P-36310	280 x 115 mm	40	50/1
P-32976	280 x 115 mm	60	10/1
P-36326	280 x 115 mm	60	50/1
P-36273	280 x 115 mm	80	10/1
P-36332	280 x 115 mm	80	50/1
P-32982	280 x 115 mm	100	10/1
P-36348	280 x 115 mm	100	50/1
P-36289	280 x 115 mm	120	10/1
P-36354	280 x 115 mm	120	50/1
P-32998	280 x 115 mm	150	10/1
P-36360	280 x 115 mm	150	50/1
P-36295	280 x 115 mm	180	10/1
P-36376	280 x 115 mm	180	50/1
P-36304	280 x 115 mm	240	10/1
P-36382	280 x 115 mm	240	50/1

## Brusna hartija - 14 rupa

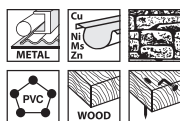

Model	Dimenzija	Granulacija	Jedinica (Kom/kompl)
P-33009	280 x 115 mm	40	10/1
P-35645	280 x 115 mm	40	50/1

P-33015	280 x 115 mm	60	10/1
P-35651	280 x 115 mm	60	50/1
P-33021	280 x 115 mm	80	10/1
P-35667	280 x 115 mm	80	50/1
P-33037	280 x 115 mm	100	10/1
P-35673	280 x 115 mm	100	50/1
P-33043	280 x 115 mm	120	10/1
P-35689	280 x 115 mm	120	50/1
P-33059	280 x 115 mm	150	10/1
P-35695	280 x 115 mm	150	50/1
P-33065	280 x 115 mm	180	10/1
P-35704	280 x 115 mm	180	50/1
P-35710	280 x 115 mm	240	50/1

Pričvršćivanje s čičkom.

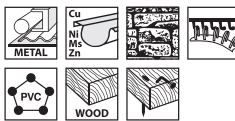

Model	Dimenzija	Granulacija	Jedinica (Kom/kompl)
P-43022	229 x 115 mm	40	10/1
P-43103	229 x 115 mm	40	50/1
P-43038	229 x 115 mm	60	10/1
P-43119	229 x 115 mm	60	50/1
P-43044	229 x 115 mm	80	10/1
P-43125	229 x 115 mm	80	50/1
P-43050	229 x 115 mm	100	10/1
P-43131	229 x 115 mm	100	50/1
P-43066	229 x 115 mm	120	10/1
P-43147	229 x 115 mm	120	50/1
P-43072	229 x 115 mm	150	10/1
P-43153	229 x 115 mm	150	50/1
P-43169	229 x 115 mm	180	50/1
P-43094	229 x 115 mm	240	10/1
P-43175	229 x 115 mm	240	50/1

## Brusna hartija - 10 rupa

Pričvršćivanje s čičkom.

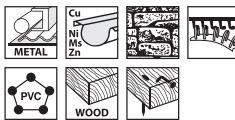

Model	Dimenzija	Granulacija	Jedinica (Kom/kompl)
P-33174	229 x 115 mm	40	10/1
P-35726	229 x 115 mm	40	50/1
P-33180	229 x 115 mm	60	10/1
P-35732	229 x 115 mm	60	50/1
P-33196	229 x 115 mm	80	10/1
P-33205	229 x 115 mm	100	10/1
P-35754	229 x 115 mm	100	50/1
P-33211	229 x 115 mm	120	10/1
P-35760	229 x 115 mm	120	50/1
P-33227	229 x 115 mm	150	10/1
P-35776	229 x 115 mm	150	50/1
P-33233	229 x 115 mm	180	10/1
P-35782	229 x 115 mm	180	50/1
P-35798	229 x 115 mm	240	50/1

Akumulat orni i punjači  
Pribor za akumulat orske pjalate  
Akumulat orske lampe i pribor  
Pribor za laserske merace  
Pribor za rušenje i udarno bušenje  
Pribor za bušenje  
Krunaste testere  
Pribor za pritezanje  
Pribor za sečenje i brušenje  
Pribor za brušenje i poliranje  
Pribor za profilisanje i poravnaj  
Pribor za višenamenski alat  
Pribor za testere  
Pribor za pneumatske alate  
Pribor za fenove za vrući vazduh  
Pribor za usisivanje  
Pribor za alate za rad na otvoreno  
Pribor za držače alata i zaštitna  
Koferi i torbe  
Ručni alati  
Ostalo  
Pribor za mješanje

## Trouglasta brusna hartija - 6 rupa

Pričvršćivanje s čičkom.



Model	Dimenzija	Granulacija	Jedinica (Kom/kompl)
P-33255	94 × 94 × 94 mm	40	10/1
P-42597	94 × 94 × 94 mm	40	50/1
P-33261	94 × 94 × 94 mm	60	10/1
P-42606	94 × 94 × 94 mm	60	50/1
P-33277	94 × 94 × 94 mm	80	10/1
P-42612	94 × 94 × 94 mm	80	50/1
P-33283	94 × 94 × 94 mm	100	10/1
P-42628	94 × 94 × 94 mm	100	50/1
P-33299	94 × 94 × 94 mm	120	10/1
P-33308	94 × 94 × 94 mm	150	10/1
P-33314	94 × 94 × 94 mm	180	10/1
P-42656	94 × 94 × 94 mm	180	50/1
P-33320	94 × 94 × 94 mm	240	10/1
P-42662	94 × 94 × 94 mm	240	50/1
P-33336	94 × 94 × 94 mm	320	10/1
P-42678	94 × 94 × 94 mm	320	50/1

Pričvršćivanje s čičkom.



Model	Dimenzija	Granulacija	Jedinica (Kom/kompl)
P-42684	94 × 94 × 94 mm	40	10/1
P-42771	94 × 94 × 94 mm	40	50/1
P-42690	94 × 94 × 94 mm	60	10/1
P-42787	94 × 94 × 94 mm	60	50/1
P-42709	94 × 94 × 94 mm	80	10/1
P-42793	94 × 94 × 94 mm	80	50/1
P-42715	94 × 94 × 94 mm	100	10/1
P-42802	94 × 94 × 94 mm	100	50/1
P-42721	94 × 94 × 94 mm	120	10/1
P-42818	94 × 94 × 94 mm	120	50/1
P-42737	94 × 94 × 94 mm	150	10/1
P-42824	94 × 94 × 94 mm	150	50/1
P-42743	94 × 94 × 94 mm	180	10/1
P-42830	94 × 94 × 94 mm	180	50/1
P-42759	94 × 94 × 94 mm	240	10/1
P-42846	94 × 94 × 94 mm	240	50/1
P-42765	94 × 94 × 94 mm	320	10/1
P-42852	94 × 94 × 94 mm	320	50/1

## Brusna hartija u rolnama

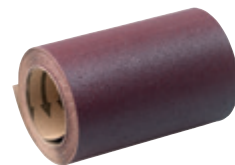
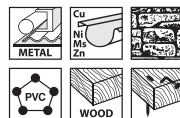

Model	Širina	Dužina	Granulacija
P-38196	120 mm	50 m	40
P-38102	120 mm	5 m	40
P-38205	120 mm	50 m	60
P-38118	120 mm	5 m	60
P-38211	120 mm	50 m	80
P-38124	120 mm	5 m	80
P-38227	120 mm	50 m	100
P-38130	120 mm	5 m	100
P-38233	120 mm	50 m	120
P-38146	120 mm	5 m	120
P-38249	120 mm	50 m	180
P-38152	120 mm	5 m	180
P-38255	120 mm	50 m	240
P-38168	120 mm	5 m	240
P-38174	120 mm	5 m	320
P-38277	120 mm	50 m	400
P-38180	120 mm	5 m	400

## Vodootporne brusne hartije

Pogodna za sve vibracione brusilice i ručno brušenje.



Model	Dimenzija	Granulacija	Jedinica (Kom/kompl)
D-58936	230 × 280 mm	60	50/1
D-58942	230 × 280 mm	80	50/1
D-58958	230 × 280 mm	100	50/1
D-58964	230 × 280 mm	120	50/1
D-58970	230 × 280 mm	150	50/1
D-58986	230 × 280 mm	180	50/1
D-58992	230 × 280 mm	220	50/1
D-59003	230 × 280 mm	280	50/1
D-59019	230 × 280 mm	320	50/1
D-59025	230 × 280 mm	400	50/1
D-59031	230 × 280 mm	600	50/1
D-59047	230 × 280 mm	800	50/1
D-59053	230 × 280 mm	1.000	50/1
D-56867	230 × 280 mm	1.200	50/1
D-59069	230 × 280 mm	1.500	50/1
D-59075	230 × 280 mm	2.000	50/1

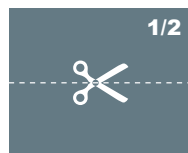

BO4900

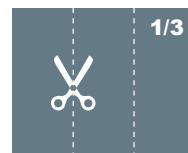

BO3710

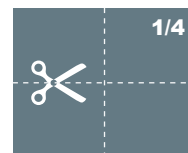

BO4555



## Ostali pribor za brusilice za poliranje

### Ploče za tračne brusilice



Model	Naziv	Za model
421093-8	Ploča od elastične plute	9401, 9402
421646-3	Ploča od elastične plute	9403
423035-8	Ploča od elastične plute	9924DB
423312-8	Ploča od elastične plute	9903
423313-6	Ploča od elastične plute	9920
423314-4	Ploča od elastične plute	9404
421648-9	Ugljena ploča	9403
423036-6	Ugljena ploča	9924DB
423315-2	Ugljena ploča	9903
423316-0	Ugljena ploča	9920
423317-8	Ugljena ploča	9404
A-86262	Ugljena ploča	9401, 9402
150980-1	Čelična ploča i ploča od plute	9403
151750-1	Čelična ploča i ploča od plute	9920
151751-9	Čelična ploča i ploča od plute	9403
151749-6	Čelična ploča	9903
341705-6	Čelična ploča	9924DB
345503-0	Čelična ploča	9910, 9911

### Ostali pribor



Model	Naziv	Za model
125157-7	Ručica 6 mm	9032, DBS180
125158-5	Ručica 9 mm	9032, DBS180
125159-3	Ručica 13 mm	9032, DBS180
191N60-8	Štitnik za prašinu	DBS180
193618-5	Postolje	9032, DBS180
342152-4	Ravna papučica	9030, 9031

### Ploče za perforaciju



Model	Dimenzija	Za model
163292-3	185 × 93 mm	9036
192523-3	280 × 115 mm	BO4900V, 9046
192989-7	185 × 93 mm	BO3700, BO3710, BO3711
450066-4	102 × 114 mm	BO4555, BO4556, BO4557

### Stalci za tračne brusilice



Model	Za model	
193055-3	9404, 9903, 9902, 9920	
STEX122299	9924DB	

### Okviri za tračne brusilice



Model	Za model	
193070-7	9903, 9902	
193072-3	9404	

### Podloge - čičak



Model	Dimenzija	Za model
194930-6	185 × 93 mm	BO3700, BO3710, BO3711

### Stege



Model	Za model	Jedinica (kom/kompl)
192694-6	9910, 9911	2/1

Akumulat  
ori i  
punjači

Pribor za  
akumulat  
orske  
alate

Akumulat  
orske  
lampe i  
pribor

Pribor za  
laserske  
merace

Pribor za  
rušenje i  
udarno  
bušenje

Pribor za  
bušenje

Krunaste  
testere

Pribor za  
pritezani  
e

Pribor za  
sečenje i  
brusjenje

Pribor za  
brusjenje  
i  
poliranje

Pribor za  
profilisanje  
e i  
poravnava

Pribor za  
višenam  
enski alat

Pribor za  
testere

Pribor za  
pneumat  
ske alate

Pribor za  
fenove  
za vrući  
vazduh

Pribor za  
usisivani  
e

Pribor za  
alate za  
rad na  
otvoreno

Pribor za  
držače  
alata i  
zaštitna

Koferi i  
torbe

Ručni  
alati

Ostalo

Pribor za  
mješanje

# GLODALA ZA METAL OD VOLFRAM KARBIDA

## VRSTA REZA I PRIMENA

### Standardni rez

Karakteristika: visoka efikasnost  
Površina: hrapava  
Materijal: metal, nerđajući čelik



### Dijamatski rez

Karakteristika: manje vibracija  
Površina: glatka  
Materijal: metal, nerđajući čelik



### Rez za obojene metale

Karakteristika: manje začepljenja  
Površina: hrapava  
Materijal: obojeni metali, plastika



## POGODNO ZA

### Materijali:

čelik, liveno gvožđe, nerđajući čelik, nikal-kobalt, obojeni metali, aluminijum ...



## OBLIK GLAVE I PRIMENA

Oblik: A

Oblik: C

Oblik: F

Oblik: L

Oblik: M

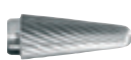
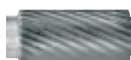

Za uklanjanje pucni sa nerđajućeg čelika



Za uklanjanje pucni sa aluminijuma



Za brušenje šava za zavarivanje između čeličnih ploča



	Šifra artikla	Jedinica (kom/kompl)	Oblik glave	Vrsta reza	Dimenzija	Prihvat	Pogodno za
	B-52716-10	10/1	A	standardni rez	10x20 mm	6 mm	čelik, nerđajući čelik
	B-52716	1					
	B-52722-10	10/1	A	dijamatski rez	10x20 mm	6 mm	čelik, nerđajući čelik
	B-52722	1					
	B-52738-10	10/1	A	rez za obojene metale	10x20 mm	6 mm	obojeni metali
	B-52738	1					
	B-52744-10	10/1	C	standardni rez	10x20 mm	6 mm	čelik, nerđajući čelik
	B-52744	1					
	B-52750-10	10/1	C	dijamatski rez	10x20 mm	6 mm	čelik, nerđajući čelik
	B-52750	1					
	B-52766-10	10/1	C	rez za obojene metale	10x20 mm	6 mm	obojeni metali
	B-52766	1					
	B-52772-10	10/1	F	standardni rez	10x20 mm	6 mm	čelik, nerđajući čelik
	B-52772	1					
	B-52788-10	10/1	F	dijamatski rez	10x20 mm	6 mm	čelik, nerđajući čelik
	B-52788	1					
	B-52794-10	10/1	F	rez za obojene metale	10x20 mm	6 mm	obojeni metali
	B-52794	1					
	B-52803-10	10/1	L	standardni rez	10x25 mm	6 mm	čelik, nerđajući čelik
	B-52803	1					
	B-52819-10	10/1	L	dijamatski rez	10x25 mm	6 mm	čelik, nerđajući čelik
	B-52819	1					
	B-52825-10	10/1	L	rez za obojene metale	10x25 mm	6 mm	obojeni metali
	B-52825	1					
	B-52831-10	10/1	M	standardni rez	10x20 mm	6 mm	čelik, nerđajući čelik
	B-52831	1					
	B-52847-10	10/1	M	dijamatski rez	10x20 mm	6 mm	čelik, nerđajući čelik
	B-52847	1					
	B-52853-10	10/1	M	rez za obojene metale	10x20 mm	6 mm	obojeni metali
	B-52853	1					

# Pribor za brušenje i poliranje

## Ravne brusilice

### Lamelarni diskovi za brušenje

Precizno brušenje različitih materijala. Lamelarni diskovi za završnu obradu sa bušilicama (10-16 mm) i čeonim brusilicama sa regulacijom obrtaja. Zbog svoje fleksibilne strukture, lamelarni diskovi obezbeđuju precizni rad sa brušenjem u različitim dimenzijama i raznim oblicima materijala, kao što su cevi, pravougli profili, zakrivljene površine itd.

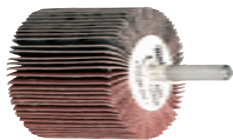
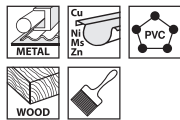

Model	Prečnik	Širina	Najveći broj obrtaja	Granulacija
B-36865	50,8 mm	25,4 mm	15.300 min <sup>-1</sup>	40
B-36918	50,8 mm	38,1 mm	15.300 min <sup>-1</sup>	40
B-36968	50,8 mm	50,8 mm	15.300 min <sup>-1</sup>	40
B-37013	63,5 mm	25,4 mm	12.700 min <sup>-1</sup>	40
B-37063	76 mm	25,4 mm	10.000 min <sup>-1</sup>	40
B-37116	76 mm	50,8 mm	10.000 min <sup>-1</sup>	40
B-36871	50,5 mm	25,4 mm	15.300 min <sup>-1</sup>	60
B-36924	50,8 mm	38,1 mm	15.300 min <sup>-1</sup>	60
B-36974	50,8 mm	50,8 mm	15.300 min <sup>-1</sup>	60
B-37029	63,5 mm	25,4 mm	12.700 min <sup>-1</sup>	60
B-37079	76 mm	25,4 mm	10.000 min <sup>-1</sup>	60
B-37122	76 mm	50,8 mm	10.000 min <sup>-1</sup>	60
B-36887	50,5 mm	25,4 mm	15.300 min <sup>-1</sup>	80
B-36930	50,8 mm	38,1 mm	15.300 min <sup>-1</sup>	80
B-36980	50,8 mm	50,8 mm	15.300 min <sup>-1</sup>	80
B-37035	63,5 mm	25,4 mm	12.700 min <sup>-1</sup>	80
B-37085	76 mm	25,4 mm	10.000 min <sup>-1</sup>	80
B-37138	76 mm	50,8 mm	10.000 min <sup>-1</sup>	80
B-36893	50,8 mm	25,4 mm	15.300 min <sup>-1</sup>	120
B-36946	50,8 mm	38,1 mm	15.300 min <sup>-1</sup>	120
B-36996	50,8 mm	50,8 mm	15.300 min <sup>-1</sup>	120
B-37041	63,5 mm	25,4 mm	12.700 min <sup>-1</sup>	120
B-37091	76 mm	25,4 mm	10.000 min <sup>-1</sup>	120
B-37144	76 mm	50,8 mm	10.000 min <sup>-1</sup>	120
B-36902	50,8 mm	25,4 mm	15.300 min <sup>-1</sup>	180
B-36952	50,8 mm	38,1 mm	15.300 min <sup>-1</sup>	180
B-37007	50,8 mm	50,8 mm	15.300 min <sup>-1</sup>	180
B-37057	63,5 mm	25,4 mm	12.700 min <sup>-1</sup>	180
B-37100	76 mm	25,4 mm	10.000 min <sup>-1</sup>	180
B-37150	76 mm	50,8 mm	10.000 min <sup>-1</sup>	180

### Stezne čaure i navrtke



Konusna stezna čaura	Navrtka	Prečnik	Za model
763627-4	763606-2	3 mm	906
763620-8		6 mm	
763627-4	763664-8	3 mm	GD0601
763620-8		6 mm	
763627-4	763236-9	3 mm	GD0603
763620-8		6 mm	

763669-8		3 mm	
763670-3	763668-0	6 mm	GD0602, BGD800, DGD800
763671-1		8 mm	

Konusna stezna čaura	Navrtka	Prečnik	Za model
193011-3		3 mm	
193012-1	763645-2	6 mm	GD0800C, GD0810C
192988-9		8 mm	

## Dvostrane stone brusilice

### Brusni diskovi za metal



Model	Tip ploče	Prečnik diska	Prečnik rupe	Debljina diska
B-51895	A60	150 mm	12,7 mm	6,4 mm
B-51904	A36M	150 mm	12,7 mm	16 mm
B-51910	A60M	150 mm	12,7 mm	16 mm
B-51926	WA60K	150 mm	12,7 mm	16 mm
B-51948	A36P	205 mm	15,88 mm	19 mm
B-51954	A60P	205 mm	15,88 mm	19 mm
B-51960	WA60K	205 mm	15,88 mm	19 mm

### Brusni diskovi za obojeni metal



Model	Tip brusnog diska	Prečnik diska	Prečnik rupe	Debljina diska
B-51932	GC120H	150 mm	12,7 mm	16 mm
B-51976	GC120H	205 mm	15,88 mm	19 mm

Akumulat  
ori i  
punjači

Pribor za  
akumulat  
orske  
rulate

Akumulat  
orske  
lampe i  
pribor

Pribor za  
laserske  
merace

Pribor za  
rušenje i  
udarno  
bušenje

Pribor za  
bušenje

Krunaste  
testere

Pribor za  
pritezani  
e

Pribor za  
sečenje i  
brušenje

Pribor za  
brušenje  
i  
poliranje

Pribor za  
profilisanje  
i  
poravnava

Pribor za  
višenam  
enski alat

Pribor za  
testere

Pribor za  
pneumat  
ske alate

Pribor za  
fenove  
vazduh

Pribor za  
usisivanje

Pribor za  
alate za  
rad na  
otvoreno

Pribor za  
držače  
alata i  
zaštitna

Koferi i  
torbe

Ručni  
alati

Ostalo

Pribor za  
mješanje



## Pribor za poliranje/brusilice

### Brusni diskovi za GV6010

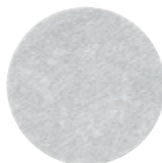

Model	Prečnik	Granulacija	Jedinica (Kom/kompl)
794274-0	150 mm	WA60	10/1
794275-8	150 mm	WA100	10/1
794276-6	150 mm	WA120	10/1
794277-4	150 mm	WA150	10/1
794278-2	150 mm	WA180	10/1

### Brusna hartija

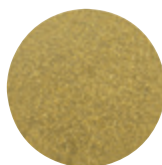

Model	Prečnik	Granulacija	Jedinica (Kom/kompl)
P-33439	180 mm	40	10/1
P-38037	180 mm	60	10/1
P-33445	180 mm	80	10/1
P-38043	180 mm	100	10/1
P-33451	180 mm	120	10/1
P-38059	180 mm	240	10/1
P-38065	180 mm	320	10/1
P-38071	180 mm	360	10/1
P-38087	180 mm	400	10/1
P-38093	180 mm	500	10/1

### Vunene podloge



Model	Prečnik	Pričvršćivanje sa čičkom	Pogodno za
197897-7	125 mm		Poliranje do visokog sijaja
D-70867	125 mm		Poliranje do visokog sijaja
794560-9	140 mm	Da	Poliranje do visokog sijaja
D-65735	150 mm		Poliranje do visokog sijaja
199424-6	150 mm	Da	Poliranje do visokog sijaja
192629-7	180 mm	Da	Poliranje drveta
794176-0	180 mm		Poliranje drveta

### Dvostrane vunene podloge



Model	Prečnik	Pričvršćivanje sa čičkom	Pogodno za
D-56954	230 mm		Grube završne radove
D-56960	/		Adapter za D-56954

# Pribor za brušenje i poliranje

## Suđeraste podloge



Model	Prečnik	Pričvršćivanje sa čičkom	Pogodno za
794558-6	125 mm		Nanošenje voska
197894-3	150 mm		Nanošenje voska
P-21727	150 mm	Da	Obradu višeslojnih boja
P-21733	150 mm	Da	Obradu celuloze, akrila, itd.
P-21749	150 mm	Da	Poliranje i mešanje

## Filcne podloge



Model	Prečnik	Pričvršćivanje sa čičkom	Pogodno za
196152-4	125 mm	Da	Uklanjanje voska
794618-4	150 mm	Da	Uklanjanje voska

## Jastučići za poliranje / ekscentrične brusilice

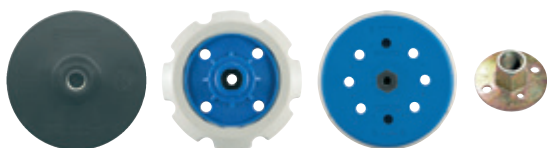

Model	Prečnik	Pričvršćivanje sa čičkom	Opis	Za model
P-21777	120 mm	Da	Za penaste polirne ploče	9237CB, PV7000C, SA5040C
743081-8	123 mm	Da	Za brušenje	BO5030, BO5031, BO5041, M2904, DBO180
743060-6	125 mm	Da	Jastučić za šmirglanje	SA5040C, 9565CVR
197922-4	125 mm	Da	Gumeni, tvrdi	DPO600, PO6000C
197928-2	150 mm	Da	Gumeni, tvrdi	DPO600, PO6000C
197317-1	130 mm	Da	Za poliranje - gumeni, tvrdi	BO6050
197315-5	150 mm	Da	Za grubo brušenje - gumeni, tvrdi	BO6050
197314-7	150 mm	Da	Za brušenje - gumeni, mekan	BO6050
197316-3	150 mm	Da	Za fino brušenje - gumeni, izuzetno mekan	BO6050
196685-9	150 mm	Da	Za grubo brušenje - gumeni, tvrdi	BO6030, BO6040
196684-1	150 mm	Da	Za brušenje - gumeni, mekan	BO6030, BO6040
196686-7	150 mm	Da	Za fino brušenje - gumeni, izuzetno mekan	BO6030, BO6040
743053-3	165 mm	Da	Za polirne podloge za 180 mm brusilice za poliranje	PV7000C, 9237CB, SA7000C
P-21761	170 mm	/	Za polirne podloge za 225 mm brusilice za poliranje	PV7000C
224515-5	M14 x 2 (DIN)	/	Stezna navrtka	9207SPB, 98237CB, SA7000C, SA5040C, PV7000C

## Ugaone brusilice

### Brusna hartija - aluminijum oksid

Brusni fiber diskovi vezani sa smolom, presvućeni sa aluminijum oksidom. Osnovni materijal je posebno otporni fibreglas. Za korišćenje sa elastičnom podlogom. Primena: Uklanjanje korozije i čišćenje metalnih površina, brušenje starih boja i premaza, nivelisanje zavara i ostataka, rubova; obaranje rubova i brušenje posuda i opreme.

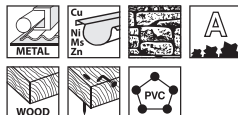

Model	Prečnik	Granulacija	Jedinica (Kom/kompl)
P-00854	115/22,23 mm	16	5/1
P-00860	115/22,23 mm	24	5/1
P-00876	115/22,23 mm	36	5/1
P-00882	115/22,23 mm	40	5/1
P-00898	115/22,23 mm	50	5/1
P-00907	115/22,23 mm	60	5/1
P-00913	115/22,23 mm	80	5/1
P-00929	115/22,23 mm	100	5/1
P-00935	115/22,23 mm	120	5/1
P-00957	125/22,23 mm	24	5/1
P-00963	125/22,23 mm	36	5/1
P-00979	125/22,23 mm	40	5/1
P-00985	125/22,23 mm	60	5/1
P-00991	125/22,23 mm	80	5/1
P-01002	125/22,23 mm	100	5/1
P-01018	125/22,23 mm	120	5/1
P-01024	180/22,23 mm	16	5/1
P-01030	180/22,23 mm	24	5/1
P-01052	180/22,23 mm	40	5/1
P-01068	180/22,23 mm	50	5/1
P-01074	180/22,23 mm	60	5/1
P-01080	180/22,23 mm	80	5/1
P-01096	180/22,23 mm	100	5/1
P-01105	180/22,23 mm	120	5/1

## Gumene podloge za brusnu hartiju



Model	Prečnik	Prihvata
P-05882	115 mm	M14
P-05898	125 mm	M14
P-05913	180 mm	M14

Akumulat  
ori i  
punjači

Pribor za  
akumulat  
orske  
alate

Akumulat  
orske  
lampe i  
pribor

Pribor za  
laserske  
merace

Pribor za  
rušenje i  
udarno  
bušenje

Pribor za  
bušenje

Krunaste  
testere

Pribor za  
pritezani  
e

Pribor za  
sečenje i  
brušenje

Pribor za  
brušenje  
i  
poliranje

Pribor za  
profilisanje  
i  
poravnav

Pribor za  
višenam  
enski alat

Pribor za  
testere

Pribor za  
pneumat  
ske alate

Pribor za  
fenove  
vazduh

Pribor za  
usisivanj  
e

Pribor za  
alate za  
rad na  
otvoreno

Pribor za  
držače  
alata i  
zaštitna

Koferi i  
torbe

Ručni  
alati

Ostalo

Pribor za  
mješanje

## Brusilica sa četkom 9741

### Brusne najlonske četke

Za strukturisanje mekanog drveta i samo za doradu strukturisanog tvrdog drveta. Za potenciranje strukture drveta i uklanjanje postojećih drvenih vlakna. Za optimalnu pripremu površina za bojenje i nagrizavanje. Za glačanje plemenitih čelika i aluminijuma.



Model	Prečnik	Širina	Granulacija
P-04422	100 mm	120 mm	60
794384-3	100 mm	120 mm	80
P-04438	100 mm	120 mm	80
P-04444	100 mm	120 mm	120
P-04450	100 mm	120 mm	180

### Valjkaste vunene četke

Za finu strukturu nerđajućih čelika i fino brušenje drvenih površina.

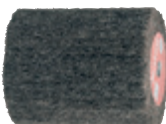

Model	Prečnik	Širina	Granulacija
P-18035	100 mm	120 mm	80
P-18041	100 mm	120 mm	120
P-18029	100 mm	120 mm	180

### Valjkaste četke sa kombinacijom lan/vuna

Za finu strukturu nerđajućih čelika i fino brušenje drvenih površina.



Model	Prečnik	Širina	Granulacija
P-18057	100 mm	120 mm	80
P-19233	100 mm	120 mm	120
P-19249	100 mm	120 mm	180

### Brusne četke

Za skidanje boja i završnu obradu.

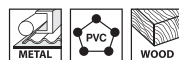

Model	Prečnik	Širina	Granulacija
P-01127	100 mm	120 mm	40
P-01155	100 mm	120 mm	80

### Četka od fibera

Za uklanjanje farbe i laka i glačanje površina.

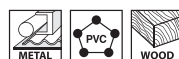

Model	Prečnik	Širina	Granulacija
P-04416	100 mm	120 mm	/

### Pamučne četke

Za poliranje čeličnih površina.



Model	Prečnik	Širina	Granulacija
794381-9	100 mm	120 mm	/

### Žičane četke

Za čišćenje rđe i betona.



Model	Prečnik	Širina	Debelina žice
P-04400	100 mm	120 mm	0,3 mm

### Mesingane žičane četke

Za obradu drveta, čišćenje i skidanje rđe.



Model	Prečnik	Širina	Debelina žice
P-65648	100 mm	120 mm	0,3 mm

# PRIBOR ZA PROFILISANJE I PORAVNAVANJE

Aluminijum



Drvo



## Standardna glodala

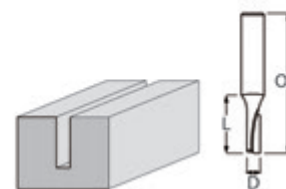

## Ravna glodala sa 1 zupcem

Model	Dužina (OL) (mm)	Širina (D) (mm)	Radna dužina (L) (mm)	Prihvat	Broj oštrica	Najveći broj obrtaja (min <sup>-1</sup> )	Cena sa PDV-om
D-47379	51	3	13	8 mm	1	28.000	
D-47385	51	4	13	8 mm	1	28.000	
D-47391	48	5	13	8 mm	1	28.000	
D-47400	50,8	6	19	8 mm	1	28.000	
D-47416	50,8	6	19	6 mm	1	28.000	

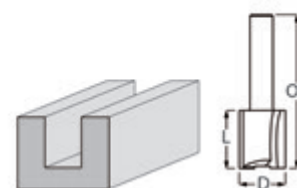

## Ravna glodala sa 2 zupca

Model	Dužina (OL) (mm)	Širina (D) (mm)	Radna dužina (L) (mm)	Prihvat	Broj oštrica	Najveći broj obrtaja (min <sup>-1</sup> )	Cena sa PDV-om
D-47444	51	8	19	6 mm	2	28.000	
D-47466	25,4	10	57,4	6 mm	2	24.000	
D-47503	48	6	16	8 mm	2	28.000	
D-47525	51	8	19	8 mm	2	28.000	
D-47531	51	10	19	8 mm	2	28.000	
D-47547	51	12	19	8 mm	2	28.000	
D-47569	55,7	16	19	8 mm	2	24.000	
D-47684	73	25	32	12 mm	2	18.000	

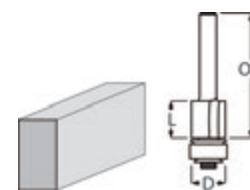

## Ravno konturno glodalo sa 2 zupca

Model	Dužina (OL) (mm)	Širina (D) (mm)	Radna dužina (L) (mm)	Prihvat	Broj oštrica	Najveći broj obrtaja (min <sup>-1</sup> )	Prečnik kugličnog ležaja (H) (mm)	Cena sa PDV-om
D-47709	56	12,7	13	6 mm	2	28.000	12,7	
D-47721	67	9,5	26	8 mm	2	24.000	9,5	
D-47737	55,7	12,7	13	8 mm	2	28.000	12,7	

Nastavak...



# Pribor za profilisanje i poravnavanje

Model	Dužina (OL) (mm)	Širina (D) (mm)	Radna dužina (L) (mm)	Prihvata	Broj oštrica	Najveći broj obrtaja (min <sup>-1</sup> )	Prečnik kugličnog ležaja (H) (mm)	Cena sa PDV-om
D-47743	68,5	12,7	26	8 mm	2	24.000	12,7	

## Ravno konturno glodalo sa 3 zupca

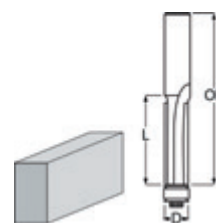

Model	Dužina (OL) (mm)	Širina (D) (mm)	Radna dužina (L) (mm)	Prihvata	Broj oštrica	Najveći broj obrtaja (min <sup>-1</sup> )	Prečnik kugličnog ležaja (H) (mm)	Cena sa PDV-om
D-47765	91,4	12,7	38	12 mm	3	24.000	9,5	

## Konturna glodala za otvore za vođenje

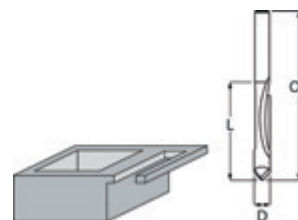

Model	Dužina (OL) (mm)	Širina (D) (mm)	Radna dužina (L) (mm)	Prihvata	Broj oštrica	Najveći broj obrtaja (min <sup>-1</sup> )	Cena sa PDV-om
D-47771	65	6,35	19	6 mm	1	28.000	
D-47787	65	6,35	19	8 mm	1	28.000	
D-47793	75	9,5	26	12 mm	1	24.000	

## Konturna glodala za V žljebove

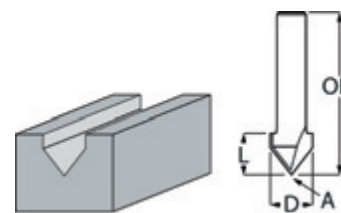

Model	Dužina (OL) (mm)	Širina (D) (mm)	Radna dužina (L) (mm)	Ugao (A) (°)	Prihvata	Broj oštrica	Najveći broj obrtaja (min <sup>-1</sup> )	Cena sa PDV-om
D-47896	44,7	12,7	12,7	90	8 mm	2	28.000	
D-47927	50,8	15,9	12,7	90	12 mm	2	24.000	
D-47955	60,3	28,6	22,2	90	12 mm	2	18.000	
D-68220	47,6	19	16	90	8 mm	2	24.000	

Akumulat orni punjači  
 Pribor za akumulat orske alate  
 Akumulat orske lampe i pribor  
 Pribor za laserske merace  
 Pribor za rušenje i udarno bušenje  
 Pribor za bušenje  
 Krunaste testere  
 Pribor za pritezanje  
 Pribor za sečenje i brušenje  
 Pribor za brušenje i poliranje  
 Pribor za profilisanje i poravnavanje  
 Pribor za višenamenski alat  
 Pribor za testere  
 Pribor za pneumatske alate  
 Pribor za fenove za vrući vazduh  
 Pribor za usisivanje  
 Pribor za alate za rad na otvoreno  
 Pribor za držače alata i zaštitna  
 Koferi i torbe  
 Ručni alati  
 Ostalo  
 Pribor za mješanje

# Pribor za profilisanje i poravnavanje

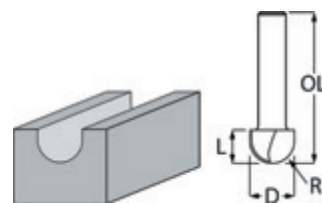

## Konturna glodala za U žlebove

Model	Dužina (OL) (mm)	Širina (D) (mm)	Radna dužina (L) (mm)	Radius (R) (mm)	Prihvat	Broj oštrica	Najveći broj obrtaja (min <sup>-1</sup> )	Cena sa PDV-om
D-48000	41,5	12,7	10	6,35	8 mm	2	28.000	
D-48016	44,5	15,8	12,7	7,9	8 mm	2	24.000	

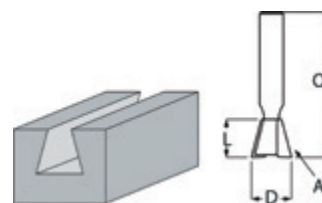

## Konturna glodala u obliku lastinog repa

Model	Dužina (OL) (mm)	Širina (D) (mm)	Radna dužina (L) (mm)	Ugao (A) (°)	Prihvat	Broj oštrica	Najveći broj obrtaja (min <sup>-1</sup> )	Cena sa PDV-om
D-48072	45	12,7	13	14	8 mm	2	28.000	
D-48103	64	25,4	22,2	14	12 mm	2	18.000	

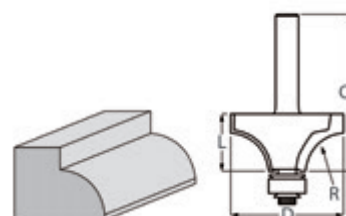

## Zaobljena konturna glodala sa kugličnim ležajem

Model	Dužina (OL) (mm)	Širina (D) (mm)	Radna dužina (L) (mm)	Radius (R) (mm)	Prihvat	Broj oštrica	Najveći broj obrtaja (min <sup>-1</sup> )	Prečnik kugličnog ležaja (H) (mm)	Cena sa PDV-om
D-48343	51	17,3	8	2,3	8 mm	2	24.000	12,7	
D-48359	53,4	19	9,5	3,2	8 mm	2	24.000	12,7	
D-48387	56,5	25,4	13,5	6,35	8 mm	2	18.000	12,7	
D-48393	57,3	28,6	14,5	7,9	8 mm	2	18.000	12,7	
D-48402	59,7	31,8	16,7	9,5	8 mm	2	18.000	12,7	
D-48418	62	38,1	19	12,7	8 mm	2	16.000	12,7	
D-48424	76,2	50,8	25,4	19	12 mm	2	14.000	12,7	

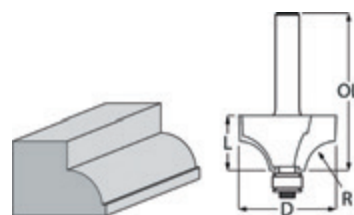

## Glodalo za četvrtinu kruga sa kugličnim ležajem

Model	Dužina (OL) (mm)	Širina (D) (mm)	Radna dužina (L) (mm)	Radijus (R) (mm)	Prihvata	Broj oštrica	Najveći broj obrtaja (min <sup>-1</sup> )	Prečnik kugličnog ležaja (H) (mm)	Cena sa PDV-om
D-48430	49,1	17	8	2,3	6 mm	2	24.000	9,5	
D-48446	51,6	19	9,5	3,2	6 mm	2	24.000	9,5	
D-48527	54,7	25,4	13,5	6,35	8 mm	2	18.000	9,5	
D-48549	57,9	31,8	17	9,5	8 mm	2	18.000	9,5	
D-48555	60,2	38,1	19	12,7	8 mm	2	16.000	9,5	
D-48561	74,5	50,8	25,4	19	12 mm	2	14.000	9,5	

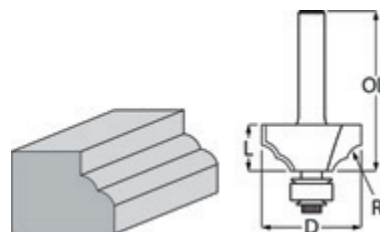

## Dvojno zaobljena konturna glodala

Model	Dužina (OL) (mm)	Širina (D) (mm)	Radna dužina (L) (mm)	Radijus (R) (mm)	Prihvata	Broj oštrica	Najveći broj obrtaja (min <sup>-1</sup> )	Prečnik kugličnog ležaja (H) (mm)	Cena sa PDV-om
D-48577	50,8	28,6	12,7	4	8 mm	2	18.000	12,7	

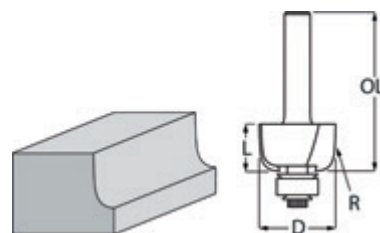

## Konturna konkavna glodala sa kugličnim ležajem

Model	Dužina (OL) (mm)	Širina (D) (mm)	Radna dužina (L) (mm)	Radijus (R) (mm)	Prihvata	Broj oštrica	Najveći broj obrtaja (min <sup>-1</sup> )	Prečnik kugličnog ležaja (H) (mm)	Cena sa PDV-om
D-48614	55,6	22,2	12,7	4,8	8 mm	2	24.000	12,7	
D-48620	55,5	28,6	12,7	7,9	8 mm	2	18.000	12,7	
D-48636	56	31,8	14	9,5	8 mm	2	18.000	12,7	

 Akumulat  
ori i  
punjači

 Pribor za  
akumulat  
orske  
alate

 Akumulat  
orske  
lampe i  
pribor

 Pribor za  
laserske  
merace

 Pribor za  
rušenje i  
udarno  
bušenje

 Pribor za  
bušenje

 Krunaste  
testere

 Pribor za  
pritezanje

 Pribor za  
sečenje i  
brusjenje

 Pribor za  
brusjenje  
i  
poliranje

 Pribor za  
profilisanje  
i  
poravnavanje

 Pribor za  
višenam  
enski alat

 Pribor za  
testere

 Pribor za  
pneumat  
ske alate

 Pribor za  
fenove  
za vrući  
vazduh

 Pribor za  
usisivanje

 Pribor za  
alate za  
rad na  
otvoreno

 Pribor za  
držače  
alata i  
zaštitna

 Koferi i  
torbe

 Ručni  
alati

Ostalo

 Pribor za  
mješanje

Akumulat  
ori i  
punjači

Pribor za  
akumulat  
orske  
alate

Akumulat  
orske  
lampe i  
pribor

Pribor za  
laserske  
merace

Pribor za  
rušenje i  
udarno  
bušenje

Pribor za  
bušenje

Krunaste  
testere

Pribor za  
pritezani  
e

Pribor za  
sečenje i  
brusenje

Pribor za  
brusenje  
i  
poliranje

Pribor za  
profilisanje  
i  
poravnavanje

Pribor za  
višenam  
enski alat

Pribor za  
testere

Pribor za  
pneumat  
ske alate

Pribor za  
fenove  
za vrući  
vazduh

Pribor za  
usisivanje

Pribor za  
alate za  
rad na  
otvoreno

Pribor za  
držače  
alata i  
zaštitna

Koferi i  
torbe

Ručni  
alati

Ostalo

Pribor za  
mješanje

### Konturna glodala za zakošenje rubova sa ležajem

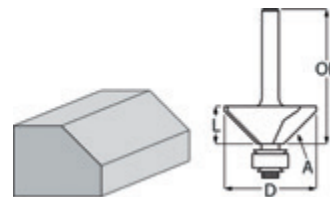

Model	Dužina (OL) (mm)	Širina (D) (mm)	Radna dužina (L) (mm)	Ugao (A) (°)	Prihvat	Broj oštrica	Najveći broj obrtaja (min <sup>-1</sup> )	Prečnik kugličnog ležaja (H) (mm)	Cena sa PDV-om
D-48658	51	25,4	11	45	6 mm	2	18.000	12,7	
D-48686	55,1	31,8	13,5	45	8 mm	2	18.000	12,7	
D-48692	58,8	34,9	16	45	8 mm	2	16.000	12,7	
D-48701	58,9	41,3	20	45	8 mm	2	16.000	12,7	
D-48723	70,9	50,8	27	45	12 mm	2	14.000	12,7	

### Konturna glodala za filete sa kugličnim ležajem

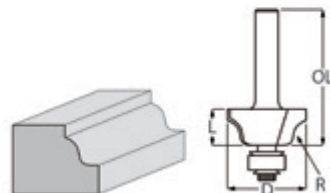

Model	Dužina (OL) (mm)	Širina (D) (mm)	Radna dužina (L) (mm)	Radius (R) (mm)	Prihvat	Broj oštrica	Najveći broj obrtaja (min <sup>-1</sup> )	Prečnik kugličnog ležaja (H) (mm)	Cena sa PDV-om
D-48751	55,3	28,6	13	4	8 mm	2	18.000	12,7	
D-48810	55,3	28,6	13	4	6 mm	2	18.000	12,7	

### Konkavna glodala za filete sa kugličnim ležajem

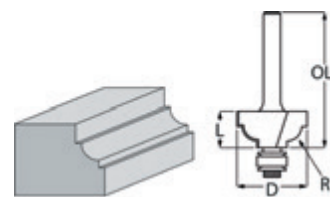

Model	Dužina (OL) (mm)	Širina (D) (mm)	Radna dužina (L) (mm)	Radius (R) (mm)	Prihvat	Broj oštrica	Najveći broj obrtaja (min <sup>-1</sup> )	Prečnik kugličnog ležaja (H) (mm)	Cena sa PDV-om
D-48795	53,7	25,4	12,7	4,8	6 mm	2	18.000	12,7	

# Pribor za profilisanje i poravnavanje

197

## Kompleti

### Komplet glodala



Model	Naziv	Prihvata	Cena sa PDV-om	
A-87921	12 kom glodala	6 mm		
D-53534	4 kom. glodala u setu	8 mm		
D-53540	6 kom glodala	8 mm		
D-53556	12 kom glodala	8 mm		

## Pribor za konturno glodanje

### Čaure i glodala

Model	Naziv	Prečnik Ø (mm)	Za model	Jedinica (kom/kompl)	Cena sa PDV-om	
763601-2	Konusna stezna čaura	12	3600B	2/1		
763615-1	Navrtka stezne čaure	/	3608B	1		
763629-0	Navrtka stezne čaure	/	3612, 3612C, M3600, M3602, MT362	1		
763622-4	Konusna stezna čaura	12,7	3612, 3612C, RP1800, RP1801, RP2300, RP2301	1		
763803-0	Stezna čaura	6,35	3612BR	1		

Nastavak...

Akumulat  
ori i  
punjači

Pribor za  
akumulat  
orske  
alate

Akumulat  
orske  
lampe i  
pribor

Pribor za  
laserske  
merace

Pribor za  
rušenje i  
udarno  
bušenje

Pribor za  
bušenje

Krunaste  
testere

Pribor za  
pritezanje

Pribor za  
sečenje i  
brusjenje

Pribor za  
brusjenje  
i  
poliranje

Pribor za  
profilisanje  
i  
poravnavanje

Pribor za  
višenam  
enski alat

Pribor za  
testere

Pribor za  
pneumat  
ske alate

Pribor za  
fenove  
za vrući  
vazduh

Pribor za  
usisivanje

Pribor za  
alate za  
rad na  
otvoreno

Pribor za  
držače  
alata i  
zaštitna















Koferi i  
torbe

Ručni  
alati

Ostalo

Pribor za  
mješanje

# Pribor za profilisanje i poravnavanje

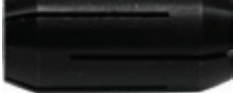
	Model	Naziv	Prečnik Ø (mm)	Za model	Jedinica (kom/kompl)	Cena sa PDV-om
	763636-3	Konusna stezna čaura	6	3620, RP0900, RT0700C	1	
	763618-5	Konusna stezna čaura	8	3620, RP0900, RT0700C, RT0702C	1	
	324149-5	Konusna stezna čaura	3,18	3706	1	
	763608-8	Konusna stezna čaura	6,35	3706	1	
	763607-0	Konusna stezna čaura	6	3706, 3708	1	
	193483-2	Burgija za drvo	3,18	3706, DCO180	1	
	733232-1	Burgija za gips karton	6,35	3706, DCO180, DCO181	1	
	733240-2	Burgija za gips karton	3,18	3706, DCO180, DCO181	1	
	763661-4	Navrtka stezne čaure	6	3709, 3710	1	
	763662-2	Konusna stezna čaura	6	3709, 3710	1	
	763663-0	Konusna stezna čaura	6,35	3709, 3710	1	
	763675-3	Navrtka stezne čaure	/	DCO180	1	
	763679-5	Konusna stezna čaura	3	DCO180	1	
	763676-1	Konusna stezna čaura	6,35	DCO180, DCO181	1	
	763677-9	Konusna stezna čaura	3,18	DCO180, DCO181	1	
	763678-7	Konusna stezna čaura	6	DCO180, DCO181	1	

[Nastavak...](#)

# Pribor za profilisanje i poravnavanje

199

Model	Naziv	Prečnik Ø (mm)	Za model	Jedinica (kom/kompl)	Cena sa PDV-om	
193178-7	Konusna stezna čaura	8	RP0910, RP1110C	2/1		
193180-0	Konusna stezna čaura	6	RP0910, RP1110C	2/1		
763674-5	Navrtka stezne čaure	/	RP1800	1		
763628-2	Konusna stezna čaura	12	RP1800, RP1801, RP2300, RP2301FCX, 3612, 3612C, RP1803F, RP2303FC	1		
763801-4	Konusna stezna čaura	6	RP1800, RP1801, RP2300, RP2301FCX, 3612, 3612C, RP1803F, RP2303FC	1		
763804-8	Konusna stezna čaura	8	RP1800, RP1801, RP2300, RP2301FCX, 3612, 3612C, RP1803F, RP2303FC	1		
763807-2	Konusna stezna čaura	10	RP1800, RP1801, RP2300, RP2301FCX, 3612, 3612C, RP1803F, RP2303FC	1		
763637-1	Konusna stezna čaura	6,35	RT0700C, RP0900	1		



## Kopirni šabloni

Model	Prečnik Ø (mm)	Prečnik nasadnog otvora Ø (mm)	Visina (mm)	Za model	Cena sa PDV-om
321492-3	35	30	7	3612, RP0900, RP1800F, RP1801F, RP2300FC, RP2301FC, RT0700C, M3600, M3601	
343577-5	10	8	10	3707, 3708, 3708F, 3711, 3712, RT0700C, RT0702C	
193330-7	9,5	7,7	11,5	RP1110C, RP1111C	
193331-5	11	9	11,5	RP1110C, RP1111C	
193332-3	12	10,5	14	RP1110C, RP1111C	
193333-1	12,7	11	11,5	RP1110C, RP1111C	
193334-9	16	14,5	11,5	RP1110C, RP1111C	
193335-7	20	18	13	RP1110C, RP1111C	
193336-5	27	24	13	RP1110C, RP1111C	
193337-3	29	25	13	RP1110C, RP1111C	
193338-1	30	27	13	RP1110C, RP1111C	
193339-9	40	37	13	RP1110C, RP1111C	
193340-4	24	22	13	RP1110C, RP1111C	

[Nastavak...](#)

Akumulat  
ori i  
punjači

Pribor za  
akumulat  
orske  
alate

Akumulat  
orske  
lampe i  
pribor

Pribor za  
laserske  
merace

Pribor za  
rušenje i  
udarno  
bušenje

Pribor za  
bušenje

Krunaste  
testere

Pribor za  
pritazani  
e

Pribor za  
sečenje i  
brusenje

Pribor za  
brusenje  
i  
poliranje

Pribor za  
profilisanje  
i  
poravnavanje

Pribor za  
višenam  
enski alat

Pribor za  
testere

Pribor za  
pneumat  
ske alate

Pribor za  
fenove  
za vrući  
vazduh

Pribor za  
uisivanje

Pribor za  
alate za  
rad na  
otvoreno

Pribor za  
držače  
alata i  
zaštitna

Koferi i  
torbe

Ručni  
alati







Ostalo

Pribor za  
mješanje

# Pribor za profilisanje i poravnavanje

Model	Prečnik Ø (mm)	Prečnik nasadnog otvora Ø (mm)	Visina (mm)	Za model	Cena sa PDV-om
163080-8	29	25	15	RP1800FX, RP2300FCX, 3612, 3612C, RP0900, RT0700C, RT0702C, M3600, M3601	
164379-4	9,5	7,7	11,5	RP1800FX, RP2300FCX, 3612, 3612C, RP0900, RT0700C, RT0702C, M3600, M3601	
164388-3	12	10	9	RP1800FX, RP2300FCX, 3612, 3612C, RP0900, RT0700C, RT0702C, M3600, M3601	
164393-0	20	18	13	RP1800FX, RP2300FCX, 3612, 3612C, RP0900, RT0700C, RT0702C, M3600, M3601	
164470-8	27	24	13	RP1800FX, RP2300FCX, 3612, 3612C, RP0900, RT0700C, RT0702C, M3600, M3601	
164471-6	30	27	13	RP1800FX, RP2300FCX, 3612, 3612C, RP0900, RT0700C, RT0702C, M3600, M3601	
164472-4	40	37 (27)	13	RP1800FX, RP2300FCX, 3612, 3612C, RP0900, RT0700C, RT0702C, M3600, M3601	
164775-6	11	9	13	RP1800FX, RP2300FCX, 3612, 3612C, RP0900, RT0700C, RT0702C, M3600, M3601	
164776-4	12,7	11	13	RP1800FX, RP2300FCX, 3612, 3612C, RP0900, RT0700C, RT0702C, M3600, M3601	
165046-4	40	37	13	RP1800FX, RP2300FCX, 3612, 3612C, RP0900, RT0700C, RT0702C, M3600, M3601	
344364-5	16	14,5	13	RP1800FX, RP2300FCX, 3612, 3612C, RP0900, RT0700C, RT0702C, M3600, M3601	

## Nasloni i vođice za glodala

Model	Naziv	Za model	Jedinica (kom/kompl)	Cena sa PDV-om
	122238-8	Osnova za glodalicu	3700B, N3701, 3703, 4402	1
	122256-6	Nosač za vođicu	3612, 3612C	1
	122391-0	Prava vođica	3707, 3708	1
	122700-3	Nosač za vođicu	RP1800, RP1803F, RP2303FC, M3602	1
	122703-7	Vođica za sečenje	3709, 3710, 3711, 3712, RT0700C, RT0702C, DRT50	1
	122704-5	Prava vođica	3709, 3711, 3712	1

[Nastavak...](#)





# Pribor za profilisanje i poravnavanje

Model	Naziv	Za model	Jedinica (kom/kompl)	Cena sa PDV-om	
122745-1	Prava vodica	3710	1		
122965-7	Ravna vodica	DRT50, RT0700C, RT0702C	1		
123022-4	Zakrivljena vodica	3612, 3612C, RP1800F, RP1801, RP2300F, RP2301	1		
123544-4	Osnova za glodalicu	3707, 3708	1		
164834-6	Prava vodica	3620, RP0910, RP1110C, RP0900, RP1111C	1		
193448-4	Kružna vodica	3706, DCO180, DCO181	1		
193904-4	Postolje za glodalicu	3707, 3708	1		
194579-2	Adapter za vodicu 1.400/3.000 mm	3612, 3612C, RP0900, RP0910, RP1110C, RP1800FC, RP1801, RP2300FCX, RP2301, RT0700C	1		
195136-9	Prava vodica	RP1800FX, RP1801, RP2300FCX, RP0900, RP0910, RP1110C, RT0700C, RP1803F, RP2303FC	1		
195138-5	Letva/šipke	RP1110C, RP0910, RP0900	2/1		
195562-2	Osnova za glodalicu za ukopavanje	RT0700C, RT0702C	1		
195563-0	Osnova za glodalicu za ukopavanje	RT0700C, RT0702C	1		
195564-8	Nosač za vodicu	DRT50, RT0700C, RT0702C	1		
196615-0	Osnova za glodalicu	RT0700C, RT0702C	1		

Nastavak...

- Akumulat orni i punjači
- Pribor za akumulat orske alat
- Akumulat orske lampe i pribor
- Pribor za laserske merace
- Pribor za rušenje i udarno bušenje
- Pribor za bušenje
- Krunaste testere
- Pribor za pritezanje
- Pribor za sečenje i brusenje
- Pribor za brusenje i poliranje
- Pribor za profilisanje i poravnavanje**
- Pribor za višenamenski alat
- Pribor za testere
- Pribor za pneumatike alat
- Pribor za fenove za vrući vazduh
- Pribor za usisivanje
- Pribor za alate za rad na otvoreno
- Pribor za držače alata i zaštitna
- Koferi i torbe
- Ručni alati
- Ostalo
- Pribor za mješanje

## Pribor za profilisanje i poravnavanje



	Model	Naziv	Za model	Jedinica (kom/kompl)	Cena sa PDV-om
	198987-9	Osnova za glodalicu	RT0700C, RT0702C	1	
	199089-4	Osnova za glodalicu za ukopavanje	DRT50, RT0702C	1	
	342428-9	Prava vodica	3612, 3612C, RP1803F, RP2303FC, M3602	1	
	418647-0	Plastična zaštita od strugotina	3711, M3700, M3702	1	
	STEX122385	Vodica za sečenje	3620, RP0900	1	

## Pribor za spajač biskivita

### Listovi za testeru od tvrdog metala

	Model	Unutrašnji prečnik (Ø) (mm)	Prečnik Ø (mm)	Broj zuba	Debljina (mm)	Najveći broj obrtaja (min <sup>-1</sup> )	Za model	Cena sa PDV-om
	B-20644	22	100	6	4,0	12.090	3901, DPJ180, PJ7000	

### Ugaona vodica sklop

	Model	Naziv	Za model	Cena sa PDV-om
	122473-8	Ugaona vodica	3901	
	123149-0	Ugaona vodica	PJ7000, DPJ180	
	415579-2	Štitnik	3901, PJ7000, DPJ180	

# Pribor za profilisanje i poravnavanje

## Glodalica za žlebljenje aluminijumskih materijala CA5000



### Listovi za glodalicu od tvrdog metala

Omogućava izradu žlebova na aluminijumskim kompozitnim materijalima, kao što su spoljašnji zidni paneli.



Model	Prečnik Ø (mm)	Unutrašnji prečnik (Ø) (mm)	Broj zuba	Dimenzija R (°)	Ugao (A) (°)	Broj obrtaja za aluminijum (min <sup>-1</sup> )	Vrsta materijala - aluminijum	Za model	Cena sa PDV-om
B-48832	118	20	6	90	90	12.940	•	CA5000	
B-48860	118	20	6	135	45	12.940	•	CA5000	

## Pribor za ravnjanje





### Noževi za rendisaljke

Model	Naziv	Širina (mm)	Za model	Jedinica (kom/kompl)	Cena sa PDV-om
A-86175	Komplet noževa za rendisaljku	82	1902, N1923B, 1923H, KP0810, KP0810C, KP0800, DKP180, DKP181, KP001G	1	
D-07945	HM nož za rendisaljku od tvrdog metala	82	1100/N, N1900B, 1902, N1923B/H, KP0810/C, KP0800, DKP180, DKP181, KP001G	2/1	
D-07951	HM nož za rendisaljku od tvrdog metala	82	1100/N, N1900B, 1902, N1923B/H, KP0810/C, KP0800, DKP180, DKP181, KP001G	4/1	
D-07967	Nož za rendisanje od tvrdog metala	82	1100/N, N1900B, 1902, N1923B/H, KP0810/C, KP0800, DKP180, DKP181, KP001G	2/1	
D-16346	HSS nož za ravnjanje	82	1100, 1902, N1923H, KP0800, KP0810, DKP180, DKP181, KP001G	2/1	
D-08822	Nož za rendisanje od tvrdog metala	110	1911B	2/1	
D-71211	HSS nož za rende	110	1911B	2/1	
D-70910	HSS nož za ravnjanje	155	1805B	2/1	
P-04248	HM nož za ravnjanje od tvrdog metala	155	1805B	2/1	



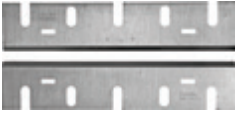







Nastavak...

- Akumulat orni i punjači
- Pribor za akumulat orske alate
- Akumulat orske lampe i pribor
- Pribor za laserske merace
- Pribor za rušenje i udarno bušenje
- Pribor za bušenje
- Krunaste testere
- Pribor za pritezanje
- Pribor za sečenje i brusenje
- Pribor za brusenje i poliranje
- Pribor za profilisanje i poravnavanje
- Pribor za višenamenski alat
- Pribor za testere
- Pribor za pneumatike alate
- Pribor za fenove za vrući vazduh
- Pribor za usisivanje
- Pribor za alate za rad na otvoreno
- Pribor za držače alata i zaštitna
- Koferi i torbe
- Ručni alati
- Ostalo
- Pribor za mješanje

# Pribor za profilisanje i poravnavanje







	Model	Naziv	Širina (mm)	Za model	Jedinica (kom/kompl)	Cena sa PDV-om
	D-63666	HSS nož za ravnanje	170	1806B	2/1	
	P-19831	HSS nož za ravnanje komplet	300	KP301	12/1	
	199911-5	HSS nož za ravnanje	306	2012NB	2/1	
	793346-8	HSS nož za ravnanje	306	2012NB	2/1	
	B-02870	HSS nož za ravnanje	312	KP312S	2/1	

## Ostali pribor

	Model	Naziv	Za model	Jedinica (kom/kompl)	Cena sa PDV-om
	122785-9	Vodica	KP0810, KP0810C	1	
	122791-4	Vodica za obaranje kosina	KP0810, KP0810C	1	
	123004-6	Držač za oštrenje 82 mm	1902, N1923B, 1923H, KP0810, KP0810C, KP0800, DKP180, KP001G	1	
	123006-2	Držač za oštrenje 155 mm	1806B	1	
	123053-3	Vodica	1806B	1	
	123055-9	Držač za oštrenje 110 mm	1911B	1	
	123062-2	Vodica za list 82 mm	1902, 1911B, N1923, 1923H, KP0810, KP0810C, KP0800, DKP181, KP001G	1	
	161046-2	Vodica	1100	1	
	164371-0	Vodica	1902, 1911B	1	
	165259-7	Vodica	N1923B, 1923H	1	

[Nastavak...](#)

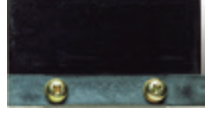
# Pribor za profilisanje i poravnavanje

Model	Naziv	Za model	Jedinica (kom/kompl)	Cena sa PDV-om	
191C22-0	Vodica za obaranje kosina	DKP181, KP001G	2/1		
191C23-8	Vodica	DKP181, KP0810/C, KP001G	1		
195055-9	Vodica	1923B, DKP180, KP0800	1		
342390-8	Graničnik za dubinu	DKP181, KP0810/C, N1923B, KP001G	1		
762014-4	Magnetni držač	2012NB	1		
762016-0	Vodica za list	2012NB	1		
JM27000328	Trougla ploča	MLT100, LS1018L, LH1200L	1		

Akumulat  
ori i  
punjači

Pribor za  
akumulat  
orske  
alate

Akumulat  
orske  
lampe i  
pribor

Pribor za  
laserske  
merace

Pribor za  
rušenje i  
udarno  
bušenje

Pribor za  
bušenje

Krunaste  
testere

Pribor za  
pritezani  
e

Pribor za  
sečenje i  
brusjenje

Pribor za  
brusjenje  
i  
poliranje

Pribor za  
profilisanj  
e i  
poravnav

Pribor za  
višenam  
enski alat

Pribor za  
testere

Pribor za  
pneumat  
ske alate

Pribor za  
fenove  
za vrući  
vazduh

Pribor za  
usisivanj  
e

Pribor za  
alate za  
rad na  
otvoreno

Pribor za  
držače  
alata i  
zaštitna

Koferi i  
torbe

Ručni  
alati

Ostalo

Pribor za  
mješanje

# PRIBOR ZA VIŠENAMENSKI ALAT

Mermer	
Krečnjak	
Aluminijum	
Metali	
Drvo	
Drvo sa ekserima	
Gips ploče	
Šperploča	
Silikon	
Lepljenje sa čičkom	
Betonski blok	
Staklena vlakna	
Nerdajući čelik	
Obojeni metali	
Plastika, PVC	
Epoksy	
Keramičke pločice	
Završni rad	
Izolacija	
Lim	
Tepih	
Produžen vek trajanja	
BIM	
BIM TIN	
HCS	
HM/TC	

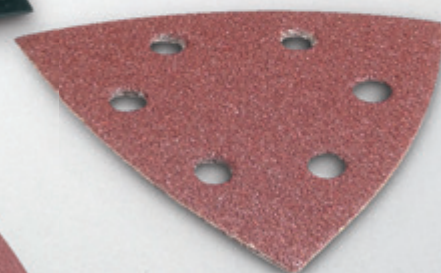
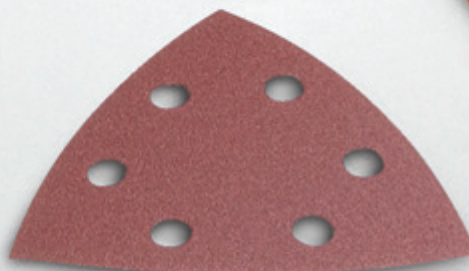
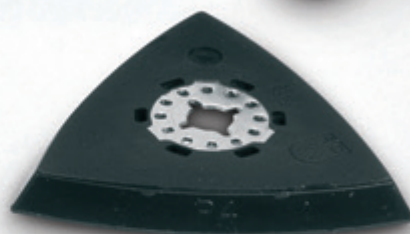







## Starlock sečiva

Kompatibilnost sa modelima

Kompatibilnost sa modelima		Prihvata		
		STARLOCK	STARLOCK PLUS	STARLOCK MAX
Prihvata alata	OIS kompatibilni alati	✓	-	-
	STARLOCK MAX	✓	✓	✓

## Segmentni listovi za drvo i metal



**BiM**



Model	Makita ID koda	Dimenzija	Material lista
B-64799	TMA045	85 mm	BiM
B-64808	TMA046	100 mm	BiM

## Listovi za ukopavanje za drvo i metal

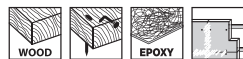

**BiM**



Model	Makita ID koda	Dimenzija	Material lista
B-64814	TMA047	32 x 50 mm	BiM
B-64814-5*	TMA047	32 x 50 mm	BiM
B-64820	TMA048	65 x 40 mm	BiM
B-64917	TMA057	10 x 30 mm	BiM
B-64923	TMA058	20 x 30 mm	BiM

\* 5 listova u paketu

## Segmentni listovi za drvo

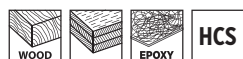

Model	Makita ID koda	Dimenzija	Material lista
B-64836	TMA049	85 mm	HCS

## Listovi za uranjanje za drvo



Model	Makita ID koda	Dimenzija	Material lista
B-64842	TMA050	24 x 50 mm	HCS
B-64842-5*	TMA050	24 x 50 mm	HCS
B-64858	TMA051	32 x 50 mm	HCS
B-64858-5*	TMA051	32 x 50 mm	HCS
B-64864	TMA052	65 x 40 mm	HCS
B-64870	TMA053	32 x 50 mm	BiM
B-64870-5*	TMA053	32 x 50 mm	BiM
B-64892	TMA055	65 x 40 mm	TC/HM
B-64886	TMA054	320 x 50 mm	HCS
B-64901	TMA056	65 x 40 mm	HCS

\* 5 listova u paketu

## Listovi za odsecanje sa ukopavanjem

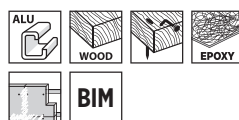

Model	Makita ID koda	Dimenzija	Material lista
B-64939	TMA059	32 x 50 mm	BiM
B-64939-5*	TMA059	32 x 50 mm	BiM

\* 5 listova u paketu

## TC listovi za uranjanje za metal

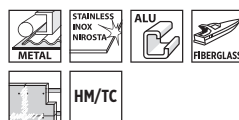

Model	Makita ID koda	Dimenzija	Material lista
B-64945	TMA060	20 x 40 mm	TC/HM
B-64951	TMA061	32 x 40 mm	TC/HM
B-69755	TMA079	45 x 40 mm	TC/HM

## Segmentni listovi za više materiala



Model	Makita ID koda	Dimenzija	Material lista
B-64973	TMA064	85 mm	BiM-TIN

Akumulat  
ori i  
punjači

Pribor za  
akumulat  
orske  
alate

Akumulat  
orske  
lampe i  
pribor

Pribor za  
laserske  
merace

Pribor za  
rušenje i  
udarno  
bušenje

Pribor za  
bušenje

Krunaste  
testere

Pribor za  
pritazani  
e

Pribor za  
sečenje i  
brusenje

Pribor za  
brusenje i  
poliranje

Pribor za  
profilisanje  
i  
poravnava

Pribor za  
višenam  
enski alat

Pribor za  
testere

Pribor za  
pneumat  
ske alate

Pribor za  
fenove  
vazduh

Pribor za  
usisivanj  
e

Pribor za  
alate za  
rad na  
otvoreno

Pribor za  
držače  
alata i  
zaštitna

Koferi i  
torbe

Ručni  
alati

Ostalo

Pribor za  
mješanje

## Segmentni listovi za linoleum

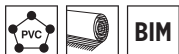

Model	Makita ID koda	Dimenzija	Material lista
B-64967	TMA063	100 mm	BiM

## Listovi za uranjanje za više materiala

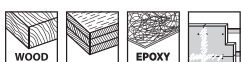

Model	Makita ID koda	Dimenzija	Material lista
B-69777	TMA081	53 x 40 mm	BiM

## TC listovi za uranjanje za više materiala



Model	Makita ID koda	Dimenzija	Material lista
B-69761	TMA080	32 x 53 mm	TC/HM

## Listovi za silikon



Model	Makita ID koda	Dimenzija	Material lista
B-65006	TMA067	28 x 40 mm	HCS
B-69783	TMA082	4 x 29 mm	/

## Višenamjenski listovi za više materiala



Model	Makita ID koda	Dimenzija	Material lista
B-65012	TMA068	11 x 24 mm	HCS

## Strugači za više materiala

HCS



Model	Makita ID koda	Dimenzija	Material lista
B-64989	TMA065	52 x 26 mm	HCS
B-64995	TMA066	52 x 26 mm	HCS

## Segmentna listovi za keramiku



Model	Makita ID koda	Dimenzija	Material lista
B-65028	TMA067	85 mm	TC/HM
B-65040	TMA071	70 mm	TC/HM

## Diamantni segmentni listovi za keramiku



Model	Makita ID koda	Dimenzija	Material lista
B-65034	TMA070	85 mm	Dijamant

## TC listovi za uranjanje za drvo i staklena vlakna



Model	Makita ID koda	Dimenzija	Material lista
B-65084	TMA075	32 x 30 mm	TC/HM

## TC listovi za uklanjanje fuga, pločica, maltera



Model	Makita ID koda	Dimenzija	Material lista
B-65078	TMA074	70 mm	TC/HM

## TC brusne ploče za šmirglanje

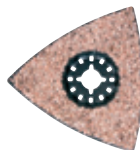

Model	Makita ID koda	Dimenzija	Material lista
B-65062	TMA073	78 mm	TC/HM #20
B-69799	TMA083	90 mm	TC/HM #20
B-69808	TMA084	90 mm	TC/HM #40
B-69814*	TMA085	90 mm	TC/HM #60
B-69820*	TMA086	90 mm	TC/HM #100

\* Samo za drvo

## Podloga za grubo čišćenje



Model	Granulacija	Dimenzija	Jedinica (Kom/kompl)
B-21808	100	94 x 94 x 94 mm	1
B-21799	280		1
B-21814	/		1

## Brusna hartija za drvo / long life



Model	Granulacija	Dimenzija	Jedinica (Kom/kompl)
B-21565	60	94 x 94 x 94 mm	10/1
B-21571	80		10/1
B-21587	100		10/1
B-21593	120		10/1
B-21602	180		10/1
B-22931	240		10/1
B-21559	60	94 x 94 x 94 mm	10/1
	80		
	100		
	120		
	180		

## Kompleti

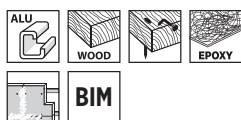

Model	Naziv	Uključuje
B-67480	Komplet za višenamenski alat	TMA045, TMA047, TMA053, TMA058
B-67496	Komplet za pločice	TMA045, TMA048, TMA051, TMA066
B-67505	Komplet za podove	TMA058, TMA065, TMA069, TMA073
B-67511	Stolarski komplet	TMA045, TMA047, TMA053, 2x TMA078

## Brusne hartije i pribor

### Držac šmirgle /čičak/



Model	Makita ID koda	Dimenzija
B-65115	TMA078	93 x 93 x 93 mm

## Brusna hartija za drvo



Model	Granulacija	Dimenzija	Jedinica (Kom/kompl)
B-21624	60	94 x 94 x 94 mm	10/1
B-21630	80		10/1
B-22947	100		10/1
B-21646	120		10/1
B-22953	150		10/1
B-21652	180		10/1
B-21668	240	94 x 94 x 94 mm	10/1
	60		
	80		
	120		
	180		
	240		

 Akumulat  
ori i  
punjači

 Pribor za  
akumulat  
orske  
alate

 Akumulat  
orske  
lampe i  
pribor

 Pribor za  
laserske  
merace

 Pribor za  
rušenje i  
udarno  
bušenje

 Pribor za  
bušenje

 Krunaste  
testere

 Pribor za  
pritezani  
e

 Pribor za  
sečenje i  
brusanje

 Pribor za  
brusanje  
i  
poliranje

 Pribor za  
profilisanje  
i  
poravnava

 Pribor za  
višenam  
enski alat

 Pribor za  
testere

 Pribor za  
pneumat  
ske alate

 Pribor za  
fenove  
za vrući  
vazduh

 Pribor za  
usisavanj  
e

 Pribor za  
alate za  
rad na  
otvoreno

 Pribor za  
držače  
alata i  
zaštitna

 Koferi i  
torbe

 Ručni  
alati

Ostalo

 Pribor za  
mješanje

## Brusna hartija za uklanjanje boja

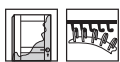

Model	Granulacija	Dimenzija	Jedinica (Kom/kompl)
B-21680	60	94 x 94 x 94 mm	10/1
B-21696	80		10/1
B-21705	100		10/1
B-22969	120		10/1
B-21711	240		10/1
B-21727	320		10/1
B-21674	60	94 x 94 x 94 mm	10/1
	80		
	100		
	240		
	320		

## Brusna hartija za kamen



Model	Granulacija	Dimenzija	Jedinica (Kom/kompl)
B-21749	120	94 x 94 x 94 mm	10/1
B-21755	240		10/1
B-21761	400		10/1
B-21777	600		10/1
B-21783	1200		10/1
B-21733	120		94 x 94 x 94 mm
	240		
	400		
	600		
	1200		

## Starlock PLUS sečiva

Kompatibilnost sa modelima

Prilivati alata	Model	Prihvati		
		STARLOCK	STARLOCK PLUS	STARLOCK MAX
OIS kompatibilni alati		✓	-	-
STARLOCK MAX		✓	✓	✓

## Listovi za odsecanje sa ukopavanjem za drvo i metal



BIM



Model	Makita ID koda	Dimenzija	Material lista
B-66329	MAP001	32 x 60 mm	BIM
B-66335	MAP002	65 x 50 mm	BIM

## Listovi za odsecanje sa ukopavanjem za drvo



HCS



Model	Makita ID koda	Dimenzija	Material lista
B-66341	MAP003	32 x 60 mm	HCS

## TC listovi za uranjanje za metal



HM/TC



Model	Makita ID koda	Dimenzija	Material lista
B-66357	MAP004	32 x 50 mm	TC/HM
B-66363	MAP005	45 x 50 mm	TC/HM

## TC Listovi za uranjanje za više materiala



HM/TC



Model	Makita ID koda	Dimenzija	Material lista
B-66379	MAP006	32 x 50 mm	TC/HM
B-66385	MAP007	52 x 50 mm	TC/HM

## TC listovi za uranjanje za abrazivne materiale



HM/TC



Model	Makita ID koda	Dimenzija	Material lista
B-66391	MAP008	53 x 40 mm	TC/HM #40

## Starlock MAX sečiva

Kompatibilnost sa modelima

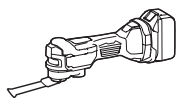

	Prihvati		
	STARLOCK	STARLOCK PLUS	STARLOCK MAX
<b>Prihvati alata</b>			
<b>OIS kompatibilni alati</b>	✓	-	-
<b>STARLOCK MAX</b>	✓	✓	✓

## Segmentni listovi za drvo i metal

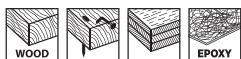

**BIM**



Model	Makita ID koda	Dimenzija	Material lista
B-66422	MAM003	100 x 50 mm	BIM

## Listovi za odsecanje sa ukopavanjem za drvo i metal

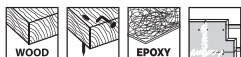

**BIM**



Model	Makita ID koda	Dimenzija	Material lista
B-66400	MAM001	32 x 80 mm	BIM
B-66416	MAM002	52 x 70 mm	BIM

## Listovi za odsecanje sa ukopavanjem za drvo i metal



**HCS**



Model	Makita ID koda	Dimenzija	Material lista
B-66438	MAM004	32 x 80 mm	HCS

## TC listovi za uranjanje za metal



**HM/TC**



Model	Makita ID koda	Dimenzija	Material lista
B-66444	MAM005	32 x 70 mm	TC/HM

## TC listovi za uranjanje za više materiala



**HM/TC**



Model	Makita ID koda	Dimenzija	Material lista
B-66450	MAM006	32 x 70 mm	TC/HM

## Listovi za silikon



**HCS**



Model	Makita ID koda	Dimenzija	Material lista
B-66466	MAM007	32 x 70 mm	HCS
B-66472	MAM008	32 x 55 mm	HCS

## TC brusne ploče za abrazivne materiale



**HM/TC**

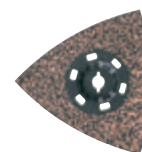

Model	Makita ID koda	Dimenzija	Material lista
B-66553	MAM015	116 mm	TC/HM #20
B-66569	MAM016	116 mm	TC/HM #40
B-66575*	MAM017	116 mm	TC/HM #60
B-66581*	MAM018	116 mm	TC/HM #100

\*Samo za drvo

Akumulat  
ori i  
punjači

Pribor za  
akumulat  
orske  
lampe i  
pribor

Akumulat  
orske  
lampe i  
pribor

Pribor za  
laserske  
merace

Pribor za  
rušenje i  
udarno  
bušenje

Pribor za  
bušenje

Krunaste  
testere

Pribor za  
pritzanje  
e

Pribor za  
sečenje i  
brusjenje

Pribor za  
brusjenje  
i  
poliranje

Pribor za  
profilisanje  
e i  
poravnane

Pribor za  
višenam  
enski alat

Pribor za  
testere

Pribor za  
pneumat  
ske alate

Pribor za  
feno  
ve za  
vrući  
vazduh

Pribor za  
usisivanje

Pribor za  
alate za  
rad na  
otvoreno

Pribor za  
držače  
alata i  
zaštita

Koferi i  
torbe

Ručni  
alati

Ostalo

Pribor za  
mješanje

## TC segmentni listovi za abrazivne materiale



Model	Makita ID koda	Dimenzija	Debelina lista	Material rezila
B-66494	MAM009	68 x 10 mm	1,5 mm	TC/HM #50
B-66503	MAM010	68 x 30 mm	2,2 mm	TC/HM #30
B-66531	MAM013	68 x 30 mm	2,1 mm	TC/HM #40
B-66547	MAM014	100 x 50 mm	1,9 mm	TC/HM #40

## Diamantni segmentni listovi za abrazivne materiale

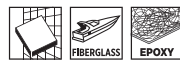

Model	Makita ID koda	Dimenzija	Debelina lista	Material rezila
B-66525	MAM012	68 x 10 mm	1,5 mm	Diamant #40
B-66519	MAM011	68 x 30 mm	2,2 mm	Diamant #40



Akumulat  
ori i  
punjači

Pribor za  
akumulat  
orske  
alate

Akumulat  
orske  
lampe i  
pribor

Pribor za  
laserske  
merace

Pribor za  
rušenje i  
udarno  
bušenje

Pribor za  
bušenje

Krunaste  
testere

Pribor za  
pritezanje

Pribor za  
sečenje i  
brusjenje

Pribor za  
brusjenje  
i  
poliranje

Pribor za  
profilisanje  
i  
poravnavanje

Pribor za  
višenamenski  
alati

Pribor za  
testere

Pribor za  
pneumatske  
alate

Pribor za  
fenove  
za vrući  
vazduh

Pribor za  
usisivanje

Pribor za  
alate za  
rad na  
otvoreno

Pribor za  
držače  
alata i  
zaštitna

Koferi i  
torbe

Ručni  
alati

Ostalo

Pribor za  
mješanje

# STARLOCK

## BRUSNI PAPIRI



★★ Preporučena ★ Odgovarajuće Bez ocene

Za materijal	Obrada	Granulacija	Artikal	Boja	Lak	Lepila	Fasada	Drvo/materijali od drveta	Meko drvo	Tvrdo drvo	Šper ploča	Iverica	Metal	Čelik	Prirodni kamen	Mermer	Granit	Staklo	Pleksiglas staklo	Corian	Fiberglass			
Drvo <b>LONG LIFE</b>	Grubo	60	B-21565																					
		80	B-21571																					
	Srednje	100	B-21587					★★	★★	★★	★★	★★	★★	★										
		120	B-21593																					
	Fino	180	B-21602																					
		240	B-22931																					
Drvo	Grubo	60	B-21624																					
		80	B-21630																					
	Srednje	100	B-22947																					
		120	B-21646					★★	★	★★	★★	★★												
	Fino	150	B-22953																					
		180	B-21652																					
240	B-21668																							
Boja	Grubo	60	B-21680																					
		80	B-21696																					
	Srednje	100	B-21705	★★	★★	★★	★★			★			★	★										
		120	B-22969																					
	Fino	240	B-21711																					
		320	B-21727																					
Prirodni kamen	Srednje	120	B-21749																					
		240	B-21755																					
	Vrlo fino	400	B-21761	★	★★										★	★	★	★	★	★	★	★	★	
		600	B-21777																					
1200	B-21783																							



# PRIBOR ZA TESTERE

- Metali 
- Aluminijum 
- Nerdajući čelik 
- Staklena vlakna 
- Drvo sa ekserima 
- Drvo 
- Sendvič paneli 
- Corian 
- Laminati 
- Malter 
- Plastika, PVC 
- Led 
- Fino sečenje 
- Grubo sečenje 
- Uzdužno sečenje 
- Poprečno sečenje 
- Brzo sečenje 
- Bajonetni prihvat lista za ubodnu testeru 
- Makita prihvat 
- Potežno-nagibna testera 
- Stona kružna testera 
- Ručna kružna testera 
- Aku. ručna kružna testera 
- Aku. sabljasta testera 
- Aku. testera za koso sečenje 
- Akumulatorska ubodna testera 
- Produžen vek trajanja 





# LISTOVI ZA TESTERU

## OBLIK ZUBA

ATB	ATBR	Hi-ATB	ATAF	ATAFR
Izmenično ozubljenje sa nakošenim vrhom.	Sa dodatim ravnim zubom na ATB konfiguraciji za lakše ravno rezanje.	Naizmenično postavljene gornje ivice zuba, spoljna ivica zuba ima dužu stranu oštrice.	Izmenično ozubljenje sa nakošenim vrhom i telom zubaca.	Izmenično ozubljenje sa nakošenim vrhom i telom zubaca + ekspanzioni kanali.

M-FORCE	FTG	TCG	MTCG	SMTCG
"M-style" zupci imaju više reznih rubova čime postižu vrlo čisto sečenje.	Pljosnato ozubljenje.	Trapezno ozubljenje.	Modifikovano trapezno ozubljenje od nerđajućeg čelika.	Naizmenična trapezoidna ivica zuba sa dužom stranom na levoj ili desnoj strani.

## TEHNOLOGIJE

LASERSKI OBLIKOVAN PROREZ	PREMAZAN	UMETNUT ZUB	PCD ZUB
Sistem za ublaživanje vibracija sa sintetičkom smolom, koja je naneta u laserski oblikovanom urezu na listu testere, da bi se obezbedili lepši i tiši rezovi.	PTFE (politetrafluoroetilenski) premaz za umanjeње adhezije od ostataka i smanjenje otpora.	Oblik umetnutih zuba izrazito povećava površinu spoja pločazub i time obezbeđuje bolju podršku i snagu zuba.	PCD (Poly-Crystalline Diamond) zubi su izuzetno tvrdi i otporni na habanje. PCD zubi testere su najbolji izbor za dugotrajnu efikasnost pri rezanju fibercementnih panela.

# EFFICUT LIST TESTERE ZA DRVO



## OBLIK



**OŠTAR GORNJI RUB**  
Omogućava glatko rezanje uz manje napora.



**ZAKRIVLJENO TELO ZUBA**  
Povećana efikasnost uklanjanja otpada.



**UŽI DONJI DEO**  
Tanji oblik smanjuje otpornost pri rezanju i omogućava da baterija duže traje.

### DUŽI RADNI VEK



### BRŽE REZANJE



### DUŽI ŽIVOTNI VEK AKUMULATORA



### KOLIČINA OBAVLJENOG POSLA SA JEDNIM PUNJENJEM BATERIJE

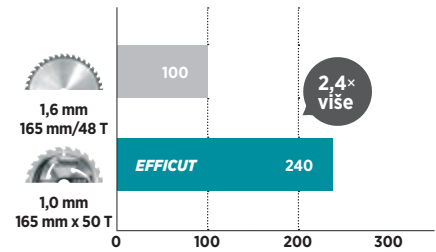

#### NAPOMENA:

1. Rezultati ispitivanja zavise od tvrdoće drveta, ...
2. Grafičke vrednosti su relativne vrednosti, gde se performanse sečenja Makita listom testere (debljina 1,0 mm) indeksiraju na 100.



# EFFICUT LISTOVI TESTERE ZA KOMPOZITNE MATERIJALE



## OBLIK



**ZAKRIVLJENO TELO ZUBA**  
Povećana efikasnost uklanjanja otpada.



**UŽI DONJI DEO**  
Tanji oblik smanjuje otpornost pri rezanju omogućava da baterija duže traje.

### KOLIČINA OBAVLJENOG POSLA SA JEDNIM PUNJENJEM BATERIJE

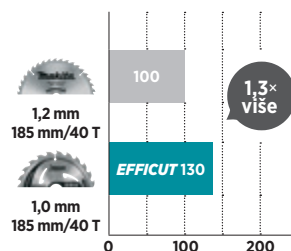

Akumulator BL1860B  
Kompozitni pod 137mm x 23mm

Poboljšani oblik Efficut zubaca za sečenje kompozitnih materijala.

- poboljšana tvrdoća vrha
- Tup ugao vrha za duži životni vek i veću radnu količinu sa jednim punjenjem baterije.

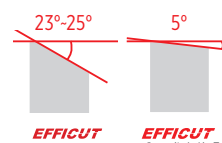

### ŽIVOTNI VEK

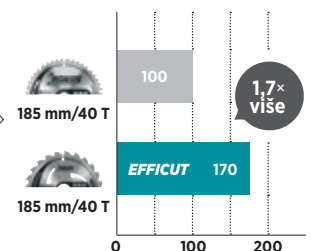

Akumulator BL1860  
Kompozitni pod 139mm x 22mm

# EFFICUT LISTOVI TESTERE ZA METAL

## OBLIK

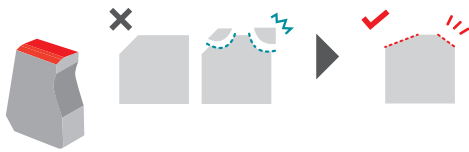

### DUGOTRAJNIJI TIP ZUBA

Poseban oblik vrha smanjuje habanje lista testere.

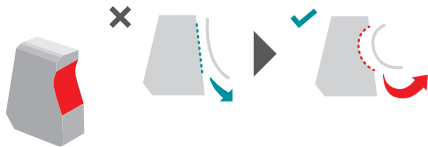

### ZAKRIVLJENO TELO ZUBA

Povećana efikasnost uklanjanja otpada.

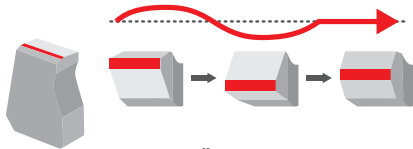

### NAIZMENIČNI TIP

Osigurava stabilno i ravno rezanje.

## DUŽI RADNI VEK

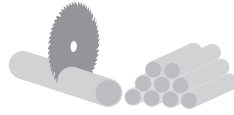

## BRŽE REZANJE



## DUŽI ŽIVOTNI VEK AKUMULATORA



**EFFICUT**  
Metal



## KOLIČINA OBAVLJENOG POSLA SA JEDNIM PUNJENJEM BATERIJE

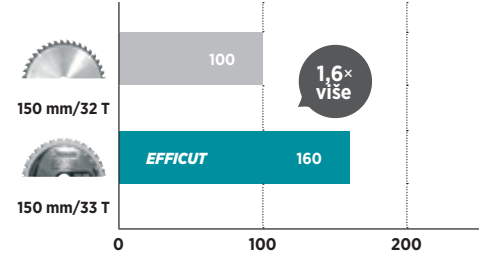

NAPOMENA: Test je urađen akumulatorskom testerom za metal DCS553 sa akumulatorom od 18V/6,0Ah. Materijal: Čelična cev prečnika 31 mm i debljine 3 mm.



# EFFICUT LISTOVI TESTERE ZA ALUMINIJUM

## OBLIKA



### TVRDI VRHOVI SA MANJE STRUGOTINA

Specijalno dizajniran vrh zuba za poboljšanu efikasnost sečenja i izdržljivost sečiva.



### ODLIČNO RAVNO REZANJE

Opterećenje vrha zuba je ravnomerno raspoređeno za manje vibracija, a time i čistiji, ravniji rez i povećanu izdržljivost vrhova.



### SMANJENA OTPORNOST NA SEČENJE

Manja otpornost na sečenje i bolja izdržljivost sečiva.



### ODLIČNO IZBACIVANJE STRUGOTINE

Doprinosi dužem životnom veku baterije smanjujući otpor rezanja.

## DUŽI RADNI VEK

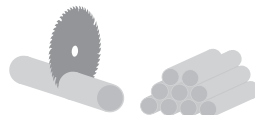

## BRŽE REZANJE



## DUŽI ŽIVOTNI VEK AKUMULATORA



## ČISTI REZ

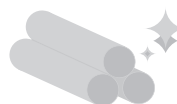

**EFFICUT**  
Aluminum



## KOLIČINA OBAVLJENOG POSLA SA JEDNIM PUNJENJEM BATERIJE

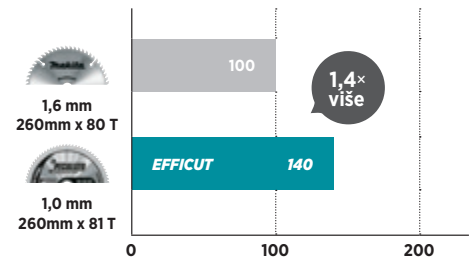

Akumulator BL1860B x2  
Aluminijumski profil, 45x45 mm, t=2 mm



## Listovi za testere od tvrdog metala



## Listovi testere za drvo

Novo razvijeni listovi testere za drvo nude kvalitet standardnih listova po nižoj ceni. Odlikuje ih odličan odnos cene i kvaliteta.



Model	Prečnik lista testere (Ø) (mm)	Unutrašnji prečnik (Ø) (mm)	Debljina lista (mm)	Broj zuba	Debljina (mm)	Dimenzija R (°)	Oblik zuba	Najveći broj obrtaja (min <sup>-1</sup> )	Gena sa PDV-om
D-64951	190	30	1,4	24	2,2	15	ATB	8.040	
D-64967	190	30	1,4	40	2,2	15	ATB	8.040	
D-64973	190	30	1,4	40	2	18	ATB	8.040	
D-72291	210	30	1,6	24	2,5	15	ATB	7.170	
D-72300	210	30	1,6	40	2,5	15	ATB	7.170	
D-74049	255	30	1,8	40	2,6	15	ATB	5.870	
D-65377	260	30	1,8	40	2,6	15	ATB	5.870	
D-65383	260	30	1,8	60	2,6	15	ATB	5.870	
D-65399	260	30	1,8	80	2,6	12	ATB	5.870	
D-65408	260	30	1,8	100	2,6	12	ATB	5.870	
D-74077	260	30	1,8	40	2,6	15	ATB	5.870	
D-72316	305	30	2,0	60	2,8	15	ATB	5.000	
D-72322	305	30	2,0	80	2,8	15	ATB	5.000	
D-72338	305	30	2,0	100	2,8	15	ATB	5.000	



## MForce listovi za testere

ČISTO SEČENJE „M-stil“ zubi imaju više reznih rubova čime postižu vrlo čisto sečenje. Sa listom za testere „Mforce“ sa 24 zuba možete da postignete iste rezultate kao sa konvencionalnim listovima sa 48 zuba.



Model	Prečnik lista testere (Ø) (mm)	Unutrašnji prečnik (Ø) (mm)	Debljina lista (mm)	Broj zuba	Debljina (mm)	Dimenzija R (°)	Oblik zuba	Najveći broj obrtaja (min <sup>-1</sup> )	Gena sa PDV-om
B-07886	165	20	1,2	10	2	15	M-FORCE	9.250	
B-07892	165	30	1,2	10	2	15	M-FORCE	9.250	
B-07901	165	20	1,2	16	2	15	M-FORCE	9.250	
B-08006	165	20	1,2	24	2	15	M-FORCE	9.250	
B-07917	170	30	1,2	16	2	15	M-FORCE	8.980	
B-08012	170	30	1,2	24	2	15	M-FORCE	8.980	
B-07923	180	20	1,2	16	2	15	M-FORCE	8.480	
B-07939	180	30	1,2	16	2	15	M-FORCE	8.480	
B-08028	180	20	1,2	24	2	15	M-FORCE	8.480	
B-08034	180	30	1,2	24	2	15	M-FORCE	8.480	
B-07945	185	30	1,2	16	2	15	M-FORCE	8.250	
B-08040	185	30	1,2	24	2	15	M-FORCE	8.250	
B-07951	190	15,88	1,2	12	2	15	M-FORCE	8.040	

Nastavak...

# Pribor za testere

Model	Prečnik lista testere (Ø) (mm)	Unutrašnji prečnik (Ø) (mm)	Debljina lista (mm)	Broj zuba	Debljina (mm)	Dimenzija R (°)	Oblik zuba	Najveći broj obrtaja (min <sup>-1</sup> )	Cena sa PDV-om
B-07967	190	30	1,2	12	2	15	M-FORCE	8.040	
B-08056	190	30	1,2	24	2	15	M-FORCE	8.040	
B-08062	190	15,88	1,2	24	2	15	M-FORCE	8.040	
B-07973	210	30	1,4	16	2,3	15	M-FORCE	7.300	
B-08078	210	30	1,4	24	2,3	15	M-FORCE	7.300	
B-08109	210	30	1,4	40	2,3	15	M-FORCE	7.300	
B-07989	230	30	1,6	18	2,3	15	M-FORCE	6.640	
B-08084	230	30	1,6	24	2,3	15	M-FORCE	6.640	
B-08115	230	30	1,6	40	2,6	15	M-FORCE	6.640	
B-07995	235	30	1,6	20	2,3	15	M-FORCE	6.500	
B-08090	235	30	1,6	24	2,3	15	M-FORCE	6.500	
B-08121	235	30	1,6	40	2,3	15	M-FORCE	6.500	



**MAKFORCE**

## MAKForce listovi za testeru

Sveobuhvatni izbor kružnih testera za sve poslove i modele prenosnih kružnih testera. Široki spektar veličina od 140 do 355 mm i broj zubaca od 10 do 60, obuhvata spektar obrade od grubih i poprečnih sečenja do posebno finih sečenja.



Model	Prečnik lista testere (Ø) (mm)	Unutrašnji prečnik (Ø) (mm)	Debljina lista (mm)	Broj zuba	Debljina (mm)	Dimenzija R (°)	Oblik zuba	Najveći broj obrtaja (min <sup>-1</sup> )	Cena sa PDV-om
B-08137	140	15,88	1	12	1,5	20	ATB	10.910	
B-08280	150	20	1,5	24	2,4	20	ATB	10.180	
B-08143	160	20	1,5	16	2,4	20	ATB	9.540	
B-08296	160	20	1,5	24	2,4	20	ATB	9.540	
B-08420	160	20	1,5	40	2,4	20	ATB	9.540	
B-08159	165	20	1,4	10	2	20	FTG	9.250	
B-08165	165	30	1,5	10	2	20	FTG	9.250	
B-08305	165	30	1,5	24	2,4	20	ATB	9.250	
B-08436	165	30	1,5	40	2,4	20	ATB	9.250	
B-08171	170	30	1,5	16	2,4	20	ATB	8.980	
B-08311	170	30	1,5	24	2,4	20	ATB	8.980	
B-08442	170	30	1,5	40	2,4	20	ATB	8.980	
B-08187	180	20	1,5	16	2,4	20	ATB	8.480	
B-08193	180	30	1,5	16	2,4	20	ATB	8.480	
B-08327	180	20	1,5	24	2,4	20	ATB	8.480	
B-08333	180	30	1,5	24	2,4	20	ATB	8.480	
B-08458	180	20	1,5	40	2,4	20	ATB	8.480	
B-08464	180	30	1,5	40	2,4	20	ATB	8.480	
B-08349	185	15,88	1,2	24	1,8	20	ATB	8.250	
B-08470	185	15,88	1,5	40	1,8	20	ATB	8.250	
B-08224	190	30	1,4	12	2	20	FTG	8.040	
B-08355	190	30	1,4	24	2,2	20	ATB	8.040	
B-08361	190	15,88	1,4	24	2,2	20	ATB	8.040	
B-08486	190	30	1,4	40	2,2	20	ATB	8.040	
B-08492	190	15,88	1,4	40	2,2	20	ATB	8.040	
B-08551	190	30	1,4	60	2,2	15	ATAF	8.040	
B-08230	210	30	1,6	16	2,4	20	ATB	7.300	
B-08377	210	30	1,6	24	2,4	20	ATB	7.300	
B-08501	210	30	1,6	40	2,4	20	ATB	7.300	

Nastavak...

- Akumulat orni i punjači
- Pribor za akumulat orske alat
- Akumulat orske lampe i pribor
- Pribor za laserske merace
- Pribor za rušenje i udarno bušenje
- Pribor za bušenje
- Krunaste testere
- Pribor za pritezanje
- Pribor za sečenje i brušenje
- Pribor za brušenje i poliranje
- Pribor za profilisanje i poravnavanje
- Pribor za višenamenski alat
- Pribor za testere**
- Pribor za pneumat ske alat
- Pribor za fenove za vrući vazduh
- Pribor za usisivanje
- Pribor za alat za rad na otvoreno
- Pribor za držače alata i zaštitna
- Koferi i torbe
- Ručni alati
- Ostalo
- Pribor za mješanje

Model	Prečnik lista testere (Ø) (mm)	Unutrašnji prečnik (Ø) (mm)	Debljina lista (mm)	Broj zuba	Debljina (mm)	Dimenzija R (°)	Oblik zuba	Najveći broj obrtaja (min <sup>-1</sup> )	Cena sa PDV-om
B-08246	230	30	1,6	18	2,6	20	ATB	6.640	
B-08383	230	30	1,6	24	2,3	20	ATB	6.640	
B-08517	230	30	1,6	40	2,6	20	ATB	6.640	
B-08567	230	30	1,8	60	2,8	15	ATAF	6.640	
B-08399	235	30	1,6	20	2,3	20	ATB	6.500	
B-08408	235	30	1,6	24	2,3	20	ATB	6.500	
B-08523	235	30	1,6	40	2,6	20	ATB	6.500	
B-08589	235	30	1,8	60	2,8	15	ATAF	6.500	
B-08268	270	30	1,8	24	2,6	20	ATB	5.650	
B-08539	270	30	1,6	40	2,6	20	ATB	5.650	
B-08573	270	30	1,8	60	2,8	15	ATAF	5.650	
B-08274	355	30	2,2	24	3	20	ATB	4.300	
B-08414	355	30	2,2	40	3	20	ATB	4.300	
B-08545	355	30	2,2	60	3	20	ATB	4.300	
B-08595	355	30	1,8	60	2,8	15	ATAF	4.300	



## MAKBlade Plus listovi za testeru

Specijalno presvučen za ekstremno nisko trenje, za glatko sečenje i zaštićen od korozije i smola.



Model	Prečnik lista testere (Ø) (mm)	Unutrašnji prečnik (Ø) (mm)	Debljina lista (mm)	Broj zuba	Debljina (mm)	Dimenzija R (°)	Oblik zuba	Najveći broj obrtaja (min <sup>-1</sup> )	Cena sa PDV-om
B-56502	165	20	1,4	64	1,9	10	ATB	9.250	
B-08604	190	20	1,6	24	2,2	5	ATB	8.040	
B-08757	190	20	1,4	60	2	5	ATAF	8.040	
B-08822	200	30	1,6	60	2,6	15	ATB	7.630	
B-09802	200	30	1,6	36	2,6	20	ATB	7.630	
B-08610	216	30	1,6	24	2,4	5	ATAF	7.070	
B-08632	216	30	1,6	48	2,4	5	ATAF	7.070	
B-08676	216	30	1,6	60	2,1	5	ATAF	7.070	
B-08791	216	30	1,8	80	2,8	5	ATAF	7.070	
B-08838	250	30	1,8	80	2,8	15	ATB	6.110	
B-09818	250	30	1,8	40	2,8	20	ATB	6.110	
B-08626	255	30	1,8	32	2,3	5	ATB	5.990	
B-08648	255	30	1,8	40	2,4	5	ATAF	5.990	
B-08682	255	30	1,8	60	2,3	5	ATAF	5.990	
B-08763	255	30	1,8	72	2,4	5	ATAF	5.990	
B-08654	260	30	1,8	40	2,3	5	ATAF	5.870	
B-08698	260	30	1,8	60	2,3	5	ATAF	5.870	
B-08707	260	30	1,8	70	2,3	5	ATAF	5.870	
B-08779	260	30	1,8	80	2,3	5	ATAF	5.870	
B-08800	260	30	1,8	100	2,3	5	ATAF	5.870	
B-08844	260	30	1,8	80	2,8	15	ATB	5.870	
B-09824	260	30	1,8	48	2,8	20	ATB	5.870	
B-17712	260	30	1,6	24	2,3	20	ATAF	5.870	
B-08850	300	30	1,8	100	2,8	15	ATB	5.090	
B-09830	300	30	1,8	48	2,8	20	ATB	5.090	
B-08660	305	30	1,8	40	2,3	5	ATAF	5.000	

Nastavak...

# Pribor za testere

Model	Prečnik lista testere (Ø) (mm)	Unutrašnji prečnik (Ø) (mm)	Debljina lista (mm)	Broj zuba	Debljina (mm)	Dimenzija R (°)	Oblik zuba	Najveći broj obrtaja (min <sup>-1</sup> )	Cena sa PDV-om
B-08713	305	30	1,8	60	2,3	5	ATAF	5.000	
B-08729	305	30	2	60	2,6	5	ATAF	5.000	
B-08735	305	30	1,9	70	2,5	0	ATAF	5.000	
B-08785	305	30	1,8	80	2,3	5	ATAF	5.000	
B-08816	305	30	1,8	100	2,3	5	ATAF	5.000	
B-08866	350	30	2	100	3	15	ATB	4.360	
B-09846	350	30	2,5	56	3,5	20	ATB	4.360	

## MAKBlade listovi za testeru

Zakaljen i precizan list za testeru apsorbira udarce i obezbeđuje usmerenu stabilnost. Fini zupci sa dugotrajnom reznom ivicom smanjuju opterećenje i pomažu da se postigne dugotrajn vek mašine i lista. Tanki listovi obezbeđuju nisko habanje i glatko sečenje.



Model	Prečnik lista testere (Ø) (mm)	Unutrašnji prečnik (Ø) (mm)	Debljina lista (mm)	Broj zuba	Debljina (mm)	Dimenzija R (°)	Oblik zuba	Najveći broj obrtaja (min <sup>-1</sup> )	Cena sa PDV-om
B-08894	190	20	1,6	24	2,2	5	ATB	8.040	
B-08953	190	20	1,6	48	2,2	5	ATB	8.040	
B-08872	216	30	1,6	40	2,1	10	ATB	7.070	
B-08903	216	30	1,6	24	2,4	5	ATB	7.070	
B-08969	216	30	1,6	48	2,4	5	ATB	7.070	
B-09058	216	30	1,4	60	2	5	ATB	7.070	
B-09092	216	30	1,8	100	2,8	5	ATB	7.070	
B-08919	250	30	1,6	32	2,4	5	ATAF	6.110	
B-08975	250	30	1,8	48	2,4	5	ATB	6.110	
B-09008	250	30	1,8	60	2,3	5	ATB	6.110	
B-09064	250	30	1,8	72	2,4	5	ATB	6.110	
B-09101	250	30	1,8	100	2,3	5	ATB	6.110	
B-08888	255	30	1,6	48	2,1	10	ATB	5.990	
B-08925	255	30	1,8	32	2,3	5	ATAF	5.990	
B-09014	255	30	1,8	60	2,3	5	ATB	5.990	
B-08931	260	30	1,8	32	2,3	5	ATAF	5.870	
B-08981	260	30	1,8	40	2,3	5	ATB	5.870	
B-09020	260	30	1,8	60	2,3	5	ATB	5.870	
B-09070	260	30	1,8	80	2,3	5	ATB	5.870	
B-09117	260	30	1,8	100	2,3	5	ATB	5.870	
B-08947	305	30	1,8	32	2,3	5	ATAF	5.000	
B-08997	305	30	1,8	40	2,3	5	ATB	5.000	
B-09036	305	30	1,8	60	2,3	5	ATB	5.000	
B-09086	305	30	1,8	80	2,3	5	ATB	5.000	
B-09123	305	30	1,8	100	2,3	5	ATB	5.000	
B-46171	315	30	2,0	28	2,8	20	ATB	4.850	
B-46187	315	30	2,0	48	2,8	10	ATB	4.850	
B-46193	315	30	2,0	60	2,8	10	ATB	4.850	

- Akumulat orni i punjači
- Pribor za akumulat orske alate
- Akumulat orske lampe i pribor
- Pribor za laserske merace
- Pribor za rušenje i udarno bušenje
- Pribor za bušenje
- Krunaste testere
- Pribor za pritezanje
- Pribor za sečenje i bušenje
- Pribor za brušenje i poliranje
- Pribor za profilisanje i poravnaj
- Pribor za višenamenski alat
- Pribor za testere**
- Pribor za pneumatike alate
- Pribor za fenove za vrući vazduh
- Pribor za usisivanje
- Pribor za alate za rad na otvoreno
- Pribor za držače alata i zaštitna
- Koferi i torbe
- Ručni alati
- Ostalo
- Pribor za mješanje



## Specialized - listovi za akumulatorske testere

Ekstra tanko, savršeno prilagođeno čelično telo za precizno sečenje. Dizajn zupca za univerzalna sečenja u drvetu. Rezni rubovi od tvrdog metala za glatko sečenje, čiste rezove i duži vek. List testere B-09248 je dizajniran za levi položaj na alatu. Pogodan za DHS680 i DSS610.



Model	Prečnik lista testere (Ø) (mm)	Unutrašnji prečnik (Ø) (mm)	Debljina lista (mm)	Broj zuba	Debljina (mm)	Dimenzija R (°)	Oblik zuba	Najveći broj obrtaja (min <sup>-1</sup> )	Cena sa PDV-om
B-14607	85	20	0,7	20	1,0	10	ATB	2.240	
B-16885	85	15	0,7	20	1,0	10	ATB	2.240	
B-09139	136	10	1,0	24	1,5	20	ATAF	4.500	
B-10643	136	20	1,0	16	1,5	20	ATAF	4.500	
B-40294	136	20	1,0	50	1,6	0	ATB	4.500	
E-06890	150	20	1,0	25	1,4	23	ATAF	10.180	
B-09151	160	20	1,0	24	1,5	20	ATAF	4.770	
B-09167	165	20	1,0	24	1,5	20	ATAF	6.500	
B-09173	165	20	1,0	24	1,5	20	ATAF	6.500	
B-09232	165	20	1,0	40	1,6	18	ATAF	6.500	
B-09248	165	20	1,0	40	1,6	18	ATAF	6.500	
B-53198	165	20	1,0	44	1,45	23	ATAFR	4.770	
B-53207	165	20	1,0	44	1,45	23	ATAFR	6.500	
B-56502	165	20	1,4	64	1,9	10	ATB	9.250	
B-56699	165	20	1,4	28	2	15	ATB	9.250	
B-56708	165	20	1,25	48	1,85	8	ATB	9.250	
B-56714	165	20	1,4	56	2	-3	TCG	9.250	
B-56720	165	20	1,4	60	2	5	HI-ATB	9.250	
B-56736	165	20	1,4	60	2	5	TCG	9.250	
B-56742	165	20	1,4	48	2	5	ATAF	9.250	
B-57320	165	20	1	56	1,45	23	ATAF	9.250	
B-62979	165	20	1,0	25	1,4	23	ATAF	9.250	
B-09195	190	30	1,4	24	2,0	20	ATAF	3.000	
B-09254	190	30	1,4	40	2,0	10	ATAF	3.000	
B-21967	190	20	1,4	24	1,9	-18	ATB	3.000	
B-53291	190	20	1,3	60	1,7	20	ATB	8.040	
B-64185	190	30	1,0	24	1,45	23	ATAF	8.040	
B-68622	190	30	1	45	1,45	23	ATAF	8.040	
E-01909	235	30	1,5	24	2,2	20	ATBR	6.500	



## Specialized - listovi za testere za uranjanje

Sistem za prigušivanje vibracija sa lasersko isečenim žljebovima napunjeni sintetičkom smolom. Specijalno telo lista omogućava korišćenje vrlo tankog lista i čisto sečenje.



Model	Prečnik lista testere (Ø) (mm)	Unutrašnji prečnik (Ø) (mm)	Debljina lista (mm)	Broj zuba	Debljina (mm)	Dimenzija R (°)	Oblik zuba	Najveći broj obrtaja (min <sup>-1</sup> )	Cena sa PDV-om
B-09260	160	20	1,6	28	2,2	23	ATB	9.540	

Nastavak...



# Pribor za testere

Model	Prečnik lista testere (Ø) (mm)	Unutrašnji prečnik (Ø) (mm)	Debljina lista (mm)	Broj zuba	Debljina (mm)	Dimenzija R (°)	Oblik zuba	Najveći broj obrtaja (min <sup>-1</sup> )	Cena sa PDV-om
B-09276	160	20	1,6	48	2,2	8	ATB	9.540	
B-09282	165	20	1,6	28	2,2	23	ATB	9.250	
B-09298	165	20	1,6	48	2,2	8	ATB	9.250	
B-56699	165	20	1,4	28	2	15	ATB	9.250	
B-56708	165	20	1,25	48	1,85	8	ATB	9.250	
B-56714	165	20	1,4	56	2	-3	TCG	9.250	
B-56720	165	20	1,4	60	2	5	HI-ATB	9.250	
B-56736	165	20	1,4	60	2	5	TCG	9.250	
B-56742	165	20	1,4	48	2	5	ATAF	9.250	
B-57320	165	20	1	56	1,45	23	ATAF	9.250	
B-09313	185	15,88	1,6	24	2,2	20	ATB	8.250	
B-19015	190	30	1,6	24	2,2	20	ATAF	8.250	

## Specialized - listovi za testeru za drvo sa čvorovima i drvo sa ekserima

Dizajnirani da odgovaraju Makinitim i testerama od drugih proizvođača, listovi sa ugrađenim vrhovima ili "Dubokim zupcima" su posebno žilavi i tvrdi. Lako se nose sa čvorovitim drvetom i normalno prodiru kroz eksere i vijke koji su ugrađeni u drvetu, bez oštećenja zubaca. Posebno su pogodni za rekultivisano drvo i za poslove za rušenje. Produženi radni vek i visok kvalitet.



Model	Prečnik lista testere (Ø) (mm)	Unutrašnji prečnik (Ø) (mm)	Debljina lista (mm)	Broj zuba	Debljina (mm)	Dimenzija R (°)	Oblik zuba	Najveći broj obrtaja (min <sup>-1</sup> )	Cena sa PDV-om
B-09329	165	20	1,3	16	2	23	ATB	9.250	
B-09391	165	20	1,3	24	2	23	ATB	9.250	
B-09472	165	20	1,3	40	2	18	ATB	9.250	
B-09335	185	15,88	1,3	16	2	25	ATB	8.250	
B-09341	185	30	1,3	16	2	25	ATB	8.250	
B-09400	185	15,88	1,3	24	2	23	ATB	8.250	
B-09416	185	30	1,3	20	2	25	ATB	8.250	
B-09494	185	30	1,3	40	2	25	ATB	8.250	
B-09357	190	30	1,3	16	2	25	ATB	8.040	
B-09422	190	30	1,3	24	2	25	ATB	8.040	
B-09503	190	30	1,3	40	2	25	ATB	8.040	
B-09363	210	30	1,4	18	1,9	25	ATB	7.300	
B-09438	210	30	1,4	24	1,9	23	ATB	7.300	
B-27246	210	30	1,8	40	2,8	20	ATB	7.300	
B-09379	235	30	1,6	20	2,3	25	ATB	6.500	
B-09444	235	30	1,6	24	2,3	23	ATB	6.500	
B-09519	235	30	1,6	48	2,3	18	ATB	6.500	
B-40624	260	30	1,8	32	2,3	5	ATAF	5.870	
B-40630	260	30	1,8	64	2,3	5	ATAF	5.870	
B-09450	270	30	1,8	24	2,6	23	ATB	5.650	
B-09525	270	30	1,8	40	2,6	18	ATB	5.650	
B-09531	270	30	1,8	60	2,6	18	ATB	5.650	
B-09385	355	30	2,2	24	3	23	ATB	4.300	
B-09466	355	30	2,2	40	3	23	ATB	4.300	
B-09547	355	30	2,2	60	3	18	ATB	4.300	

- Akumulat orni punjači
- Pribor za akumulat orske alat
- Akumulat orske lampe i pribor
- Pribor za laserske merace
- Pribor za rušenje i udarno bušenje
- Pribor za bušenje
- Krunaste testere
- Pribor za pritezanje
- Pribor za sečenje i brušenje
- Pribor za brušenje i poliranje
- Pribor za profilisanje i poravnava
- Pribor za višenamenski alat
- Pribor za testere**
- Pribor za pneumat ske alat
- Pribor za fenove za vrući vazduh
- Pribor za usisivanje
- Pribor za alat za rad na otvoreno
- Pribor za držače alata i zaštitna
- Koferi i torbe
- Ručni alati
- Ostalo
- Pribor za mješanje



## Specialized - listovi za testere za nerđajući čelik

Specijalno dizajnirani za nerđajuće čelike sa povećanom izdržljivošću.



Model	Prečnik lista testere (Ø) (mm)	Unutrašnji prečnik (Ø) (mm)	Debljina lista (mm)	Broj zuba	Debljina (mm)	Dimenzija R (°)	Oblik zuba	Najveći broj obrtaja (min <sup>-1</sup> )	Cena sa PDV-om
B-23086	136	20	1	56	1,1	0	SMTCG	4.500	
B-47014	150	20	1	60	1,1	0	SMTCG	4.680	
B-07870	185	30	1,8	40	1,8	-3	SMTCG	5.160	
B-23123	305	25,4	1,7	100	2	-3	SMTCG	2.000	



## Specialized - listovi za testere za metal

Novo razvijeni listovi za testere za sečenje metala obezbeđuju čišće rezove i brže sečenje nego ranije. Novi kompozitni karbidni materijal, u kombinaciji sa unikatnom konstrukcijom zupca, obezbeđuje odličnu otpornost na udarac. Makita listovi za sečenje metala traju do 30 puta duže od metalnih listova.



Model	Prečnik lista testere (Ø) (mm)	Unutrašnji prečnik (Ø) (mm)	Debljina lista (mm)	Broj zuba	Debljina (mm)	Dimenzija R (°)	Oblik zuba	Najveći broj obrtaja (min <sup>-1</sup> )	Cena sa PDV-om
B-10615	136	20	1,2	30	1,5	0	MTCG	4.500	
B-21973	136	20	1,1	50	1,4	-15	ATB	4.500	
B-69266	136	20	0,95	30	1,1	0	SMTCG	4.500	
B-69272	136	20	0,95	45	1,1	0	SMTCG	4.500	
B-46296	150	20	1,2	32	1,5	0	MTCG	4.680	
B-47167	150	20	1,1	52	1,4	-15	ATB	4.680	
B-69294	150	20	0,95	48	1,1	0	SMTCG	4.680	
E-02923	150	20	0,95	32	1,1	0	TCG	4.680	
B-09743	185	30	1,5	36	1,9	0	ATB	5.800	
B-09759	185	30	1,6	38	2	0	MTCG	5.800	
B-09771	185	30	1,3	70	1,7	-10	FTG	5.800	
B-09787	185	30	1,6	48	2	0	MTCG	5.800	
B-23329	185	30	1,5	48	1,9	0	SMTCG	5.800	
B-23363	185	30	1,5	56	1,8	0	SMTCG	5.800	
B-31669	185	30	1,3	64	1,6	0	SMTCG	5.800	
E-12843	185	30	1,2	60	1,4	0	SMTCG	/	
E-12859	185	30	1,2	45	1,4	0	SMTCG	/	
B-09765	305	25,4	1,7	60	2,1	0	TCG	2.000	
B-09793	305	25,4	2,3	78	2,3	-5	MTCG	2.000	
B-34132	305	25,4	2	60	2,4	0	TCG	2.000	
E-12049	305	25,4	1,75	63	2	-2	SMTCG	/	



## Specialized - listovi za testere za aluminijum

Ekstra tanki, savršeno prilagođeno čelično telo za precizno sečenje. Odlične rezne performanse u ne-feritnim metalima, zbog unikatne konstrukcije zuba.



Model	Prečnik lista testere (Ø) (mm)	Unutrašnji prečnik (Ø) (mm)	Debljina lista (mm)	Broj zuba	Debljina (mm)	Dimenzija R (°)	Oblik zuba	Najveći broj obrtaja (min <sup>-1</sup> )	Cena sa PDV-om
B-40294	136	20	1,0	50	1,6	0	ATB	4.500	
B-47020	150	20	1	52	1,6	0	ATB	4.680	
B-09553	160	20	1,8	60	2,4	0	TCG	9.540	
B-09569	160	30	1,8	60	2,4	0	TCG	9.540	
B-09307	165	20	1,7	56	2,4	-3	TCG	9.250	
B-09575	180	30	1,8	60	2,4	0	TCG	8.480	
B-09581	185	15,88	1,8	60	2,4	0	TCG	8.250	
B-09597	190	30	1,8	60	2,4	0	TCG	8.040	
B-09612	190	20	1,4	60	2	-5	TCG	8.040	
B-09690	200	30	2,2	64	2,8	0	TCG	7.630	
B-12435	210	30	1,8	60	2,4	0	TCG	/	
B-09628	216	30	1,6	64	2,2	-5	TCG	7.070	
B-09606	235	30	1,8	80	2,4	0	TCG	6.500	
B-09634	250	30	1,8	80	2,4	-5	TCG	6.110	
B-09640	250	30	1,8	100	2,4	-5	TCG	6.110	
B-09709	250	30	2,2	80	2,8	0	TCG	6.110	
B-09656	260	30	1,8	80	2,4	-5	TCG	5.870	
B-09662	260	30	1,8	100	2,4	-5	TCG	5.870	
B-09715	260	30	2,2	80	2,8	0	TCG	5.870	
E-06317	260	30	1,5	81	1,85	-3	SMTCCG	5.870	
B-09721	300	30	2,2	80	2,8	0	TCG	5.090	
B-09678	305	30	1,8	80	2,4	-5	TCG	5.000	
B-09684	305	30	1,8	100	2,4	-5	TCG	5.000	
B-09737	350	30	2,6	100	3,2	0	TCG	4.360	



## Listovi za testere za aluminijum

Model	Prečnik lista testere (Ø) (mm)	Unutrašnji prečnik (Ø) (mm)	Debljina lista (mm)	Broj zuba	Debljina (mm)	Dimenzija R (°)	Oblik zuba	Najveći broj obrtaja (min <sup>-1</sup> )	Cena sa PDV-om
D-72970	190	30 (20)	1,4	60	2,2	5	TCG	8.040	
D-72986	210	30	1,6	60	2,4	5	TCG	7.170	
D-72992	235	30	1,6	80	2,4	5	TCG	6.500	
D-73003	260	30	1,8	70	2,8	5	TCG	5.870	
D-73019	305	30	2,0	80	2,8	5	TCG	5.000	
D-73025	305	30	2,0	100	2,8	5	TCG	5.000	

Akumulatori i punjači  
 Pribor za akumulatorske alate  
 Akumulatorske lampe i pribor  
 Pribor za laserske merace  
 Pribor za rušenje i udarno bušenje  
 Pribor za bušenje  
 Krunaste testere  
 Pribor za pritezanje  
 Pribor za sečenje i brušenje  
 Pribor za brušenje i poliranje  
 Pribor za profilisanje i poravnanje  
 Pribor za višenamenski alat  
 Pribor za testere  
 Pribor za pneumatske alate  
 Pribor za fenove za vrući vazduh  
 Pribor za usisavanje  
 Pribor za alate za rad na otvoreno  
 Pribor za držače alata i zaštitna  
 Koferi i torbe  
 Ručni alati  
 Ostalo  
 Pribor za mješanje



## Specialized - listovi za testere za građevinu

Za kružne testere Specijalno dizajnirani za grube poslove na gradilištima. Robusni dizajn sa teškim i trajnim reznim zubcima.



Model	Prečnik lista testere (Ø) (mm)	Unutrašnji prečnik (Ø) (mm)	Debljina lista (mm)	Broj zuba	Debljina (mm)	Dimenzija R (°)	Oblik zuba	Najveći broj obrtaja (min <sup>-1</sup> )	Cena sa PDV-om
B-13683	190	30	1,6	12	2,6	20	FTG	8.040	
B-13699	235	30	1,8	16	2,8	20	FTG	6.500	



## Specialized - listovi za testere za sendvič ploče

Spektar listova posebno dizajniranih za sečenje metalnih kompozitnih materijala ili poznatijih kao sendvič paneli. Dva tanka metalna sloja povezana na izolaciono jezgro. Posebno dizajnirani za sečenje metalnih slojeva, ostavljajući čistu završnu obradu, sa mnogo niskom proizvodnjom toplote, da bi se sačuvala veza između dva materijala.



Model	Prečnik lista testere (Ø) (mm)	Unutrašnji prečnik (Ø) (mm)	Debljina lista (mm)	Broj zuba	Debljina (mm)	Dimenzija R (°)	Oblik zuba	Najveći broj obrtaja (min <sup>-1</sup> )	Cena sa PDV-om
B-63133	165	20	1,4	42	1,75	0	SMTCC	9250	
B-17675	235	30	1,8	50	2,2	0	SMTCC	6.500	
B-17681	270	30	2	60	2,4	0	SMTCC	5.650	
B-17697	355	30	2,2	80	2,6	0	SMTCC	4.300	



## Specialized - listovi za testere za laminat

Za akumulatorske kružne i testere za koso sečenje. Specijalno dizajnirane za sečenje laminata. Za čisto i glatko sečenje.



Model	Prečnik lista testere (Ø) (mm)	Unutrašnji prečnik (Ø) (mm)	Debljina lista (mm)	Broj zuba	Debljina (mm)	Dimenzija R (°)	Oblik zuba	Najveći broj obrtaja (min <sup>-1</sup> )	Cena sa PDV-om
B-29446	136	20	1,0	48	1,4	10	ATAF	4.500	
B-53198	165	20	1,0	44	1,45	23	ATAFR	4.770	
B-57364	165	20	1,0	56	1,45	23	ATAFR	9.250	
B-29480	250	30	1,8	84	2,5	5	TCG	6.110	
B-29496	260	30	1,8	84	2,5	5	TCG	5.870	
B-29505	305	30	1,8	96	2,5	5	TCG	5.000	



## TCT list testere za sendvič panele sa cementnim vezivom

TCT list testere za sendvič panele sa cementnim vezivom ojačano staklenom vunom.



Model	Prečnik lista testere (Ø) (mm)	Unutrašnji prečnik (Ø) (mm)	Debljina lista (mm)	Broj zuba	Debljina (mm)	Dimenzija R (°)	Oblik zuba	Najveći broj obrtaja (min <sup>-1</sup> )	Cena sa PDV-om
B-22997	165	20	1,6	4	2,3	12	FTG	9.250	
B-23014	260	30	1,8	6	2,5	8	FTG	5.870	



## Specialized - 2712



Model	Prečnik lista testere (Ø) (mm)	Unutrašnji prečnik (Ø) (mm)	Debljina lista (mm)	Broj zuba	Debljina (mm)	Dimenzija R (°)	Oblik zuba	Najveći broj obrtaja (min <sup>-1</sup> )	Cena sa PDV-om
B-46171	315	30	2,0	28	2,8	20	ATB	4.850	
B-46187	315	30	2,0	48	2,8	10	ATB	4.850	
B-46193	315	30	2,0	60	2,8	10	ATB	4.850	
JM27170001	315	30	2	40	2,8	16		4.850	



## Višenamenski tct list za ručne kružne testere

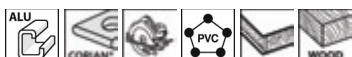

Model	Prečnik lista testere (Ø) (mm)	Unutrašnji prečnik (Ø) (mm)	Debljina lista (mm)	Broj zuba	Debljina (mm)	Dimenzija R (°)	Oblik zuba	Najveći broj obrtaja (min <sup>-1</sup> )	Cena sa PDV-om
D-65567	160	20	1,4	60	2,2	5	TCG	9.450	
D-65573	165	20	1,4	60	2,2	5	TCG	9.250	
D-65589	185	30	1,4	60	2,2	5	TCG	8.300	
D-65595	190	30	1,4	60	2,2	5	TCG	8.040	
D-65604	210	30	1,6	60	2,4	5	TCG	7.170	
D-65632	235	30/25,4	1,6	60	2,4	5	TCG	6.500	

 Akumulat  
ori i  
punjači

 Pribor za  
akumulat  
orske  
alate

 Akumulat  
orske  
lampe i  
pribor

 Pribor za  
laserske  
merace

 Pribor za  
rušenje i  
udarno  
bušenje

 Pribor za  
bušenje

 Krunaste  
testere

 Pribor za  
pritezanje

 Pribor za  
sečenje i  
brusenje

 Pribor za  
brusenje  
i  
poliranje

 Pribor za  
profilisanje  
i  
poravnava

 Pribor za  
višenam  
enski alat

 Pribor za  
testere

 Pribor za  
pneumat  
iske alate

 Pribor za  
fenove  
za vrući  
vazduh

 Pribor za  
usisivanje

 Pribor za  
alate za  
rad na  
otvoreno

 Pribor za  
držače  
alata i  
zaštitna

 Koferi i  
torbe

 Ručni  
alati

Ostalo

 Pribor za  
mješanje



### Višenamenski TCT list za potezno-nagibne testere

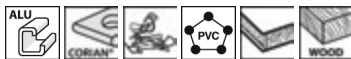

Model	Prečnik lista testere (Ø) (mm)	Unutrašnji prečnik (Ø) (mm)	Debljina lista (mm)	Broj zuba	Debljina (mm)	Dimenzija R (°)	Oblik zuba	Najveći broj obrtaja (min <sup>-1</sup> )	Cena sa PDV-om
D-65610	216	30	1,6	60	2,4	5	TCG	7.070	
D-65626	216	30	1,6	80	2,4	5	TCG	7.070	
D-65648	260	30	1,8	80	2,6	5	TCG	5.870	
D-65654	260	30	1,8	100	2,6	5	TCG	5.870	
D-65660	260	30	1,8	120	2,6	5	TCG	5.870	
D-65676	305	30	2	80	2,8	5	TCG	5.000	
D-65682	305	30	2	100	2,8	5	TCG	5.000	
D-65698	305	30	2	120	2,8	5	TCG	5.000	
D-65707	355	30	2,2	100	3	5	TCG	4.300	



### EFFICUT - listovi za akumulatorske testere



Model	Prečnik lista testere (Ø) (mm)	Unutrašnji prečnik (Ø) (mm)	Debljina lista (mm)	Broj zuba	Debljina (mm)	Dimenzija R (°)	Oblik zuba	Najveći broj obrtaja (min <sup>-1</sup> )	Cena sa PDV-om
B-62979	165	20	1,0	25	1,4	23	ATAF	9.250	
B-64185	190	30	1,0	24	1,45	23	ATAF	8.040	
B-67234	260	30	1,65	60	2,15	10	ATAFR	5.870	
B-67240	260	30	1,65	80	2,15	10	ATAFR	5.870	
B-67256	305	30	1,65	60	2,15	10	ATAFR	5.000	
B-67262	305	30	1,65	80	2,15	10	ATAFR	5.000	
B-67278	305	30	1,65	100	2,15	10	ATAFR	5.000	
B-69858	165	20	1,35	60	1,85	10	ATBR	9.250	
E-06971	216	30	1,5	45	2	10	ATBR	7.070	
E-07696	260	30	1,5	24	2,15	23	ATAFR	5.870	
E-08676	185	30	1,0	24	1,45	23	ATAFR	8.250	
E-11140	190	20	1,35	25	1,85	10	ATBR	8.040	
E-11156	190	20	1,35	45	1,85	10	ATBR	8.040	
E-11162	190	20	1,35	60	1,85	10	ATBR	8.040	



## Listovi za testere za kompozitne materiale

Model	Prečnik lista testere (Ø) (mm)	Unutrašnji prečnik (Ø) (mm)	Debljina lista (mm)	Broj zuba	Debljina (mm)	Dimenzija R (°)	Oblik zuba	Cena sa PDV-om
E-12142	165	20	1,0	24	1,5	15	ATAFR	
E-12158	165	20	1,0	40	1,5	15	ATAFR	
E-12164	185	30	1,0	24	1,5	15	ATAFR	
E-12170	185	30	1,0	40	1,5	15	ATAFR	
E-12186	190	20	1,35	50	1,85	8	ATAFR	
E-12192	216	30	1,5	60	2,0	8	ATAFR	
E-12201	260	30	1,65	75	2,15	8	ATAFR	



## Reducirni prsteni za TCT listove testere

Model	Spoljni prečnik (mm)	Unutrašnji prečnik (mm)	Debljina lista (mm)	Cena sa PDV-om
B-20987	20	15,88	1,2	
B-20993	20	15,88	1,8	
B-21004	30	15,88	1,2	
B-21010	30	15,88	1,8	
B-21026	30	20	1,2	
B-21032	30	20	1,4	
B-21048	30	20	1,8	
B-21060	30	25,4	1,4	
B-21076	30	25,4	2,2	

- Akumulat ori i punjači
- Pribor za akumulat orske alate
- Akumulat orske lampe i pribor
- Pribor za laserske merace
- Pribor za rušenje i udarno bušenje
- Pribor za bušenje
- Krunaste testere
- Pribor za pritezanje
- Pribor za sečenje i brusenje
- Pribor za brusenje i poliranje
- Pribor za profilisanje i poravnavanje
- Pribor za višenamenski alat
- Pribor za testere**
- Pribor za pneumat iske alate
- Pribor za fenove za vrući vazduh
- Pribor za usisivanje
- Pribor za alate za rad na otvoreno
- Pribor za držače alata i zaštitna
- Koferi i torbe
- Ručni alati
- Ostalo
- Pribor za mješanje

# LISTOVI ZA UBODNE TESTERE

## VRSTA ZUBA

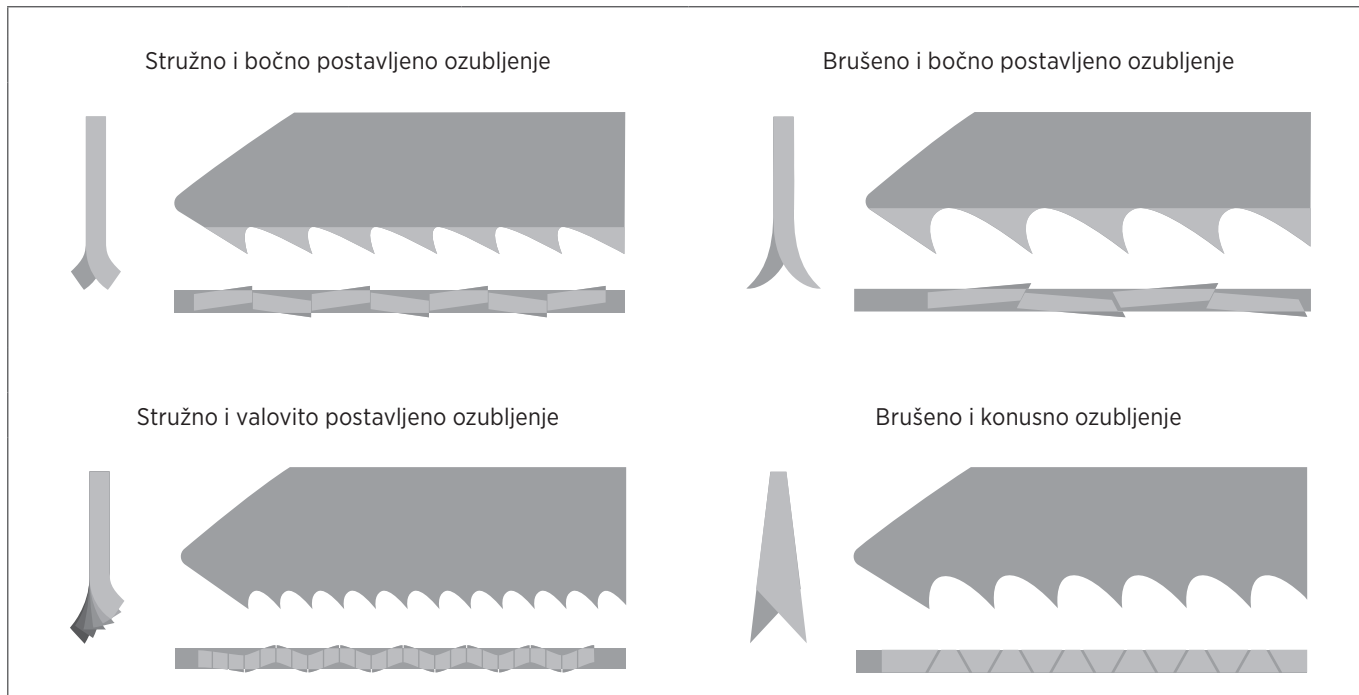

## POREĐENJE OBLIKA ZUBA I RASPOREDA ZUBA

STRUŽNO OZUBLJENJE	BRUŠENO OZUBLJENJE
<p>Za opšte testerisanje Meki do tvrdi materijali Dug životni vek sečiva</p> 	<p>Veoma oštar Precizan, čist rez Meki do tvrdi materijali</p> 

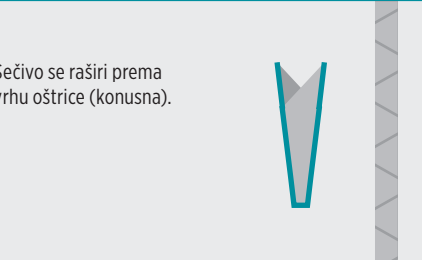
BOČNA POSTAVLJENOST	TALASASTA POSTAVLJENOST	KONUSNA POSTAVLJENOST
<p>Svaki pojedinačni zub je naizmenično savijen u levo i desno. Primer: desno, levo, pravo, itd.</p> 	<p>Zubi imaju oblik talasa.</p> 	<p>Sečivo se raširi prema vrhu oštrice (konusna).</p> 

## MATERIJAL

**HCS (Visoki karbon čelik)** za rezanje mekših materijala, kao što su drvo ili plastika.

**HSS (Tvrdi čelik)** za rezanje tvrdih materijala, kao što su metali.

**BIM (Bi-metal, HCS telo i HSS zubi)** za rezanje mekih do tvrdih materijala, kao što su drvo, metal, plastika.

**TC (Volfram karbid)** za rezanje plastike ojačane staklenim vlaknima, fiber ili gipsanih ploča, vezanih sa cementom.



## Ubodne testere

### HCS listovi za testere za drvo, grubo sečenje



Model	Tip noža	Radna dužina (mm)	Broj zuba na colu	Mekano/tvrdo drvo (mm)	Plastika (mm)	Jedinica (kom/kompl)	Cena sa PDV-om	
A-85656	B-13	70	8	4-65	4-65	5/1		
A-85662	B-14	51	18	2-35	2-35	5/1		
A-85678	B-15	50	12	3-35	3-35	5/1		
A-85709	B-18	44	14	2-35	2-35	5/1		
A-85793	BR-13	64	9	5-65		5/1		
D-34877	B-13	74	8	4-50		5/1		

### HCS listovi za testere za drvo, čisto sečenje



Model	Tip noža	Radna dužina (mm)	Broj zuba na colu	Ploče za nameštaj (mm)	Mekano/tvrdo drvo (mm)	Plastika (mm)	Jedinica (kom/kompl)	Cena sa PDV-om	
A-85628	B-10	76	9	3-65	3-65	3-65	5/1		
A-85634	B-11	73	9	3-60	3-60	3-60	5/1		
A-85640	B-12	74	6	5-65	5-65	5-65	5/1		
A-85715	B-19	63	12	3-50	3-50	3-50	5/1		
A-86290	L-1	101	6	5-90	5-90	5-90	5/1		
D-72718	B-10	74	9	4-50	4-50	4-50	5/1		

### HCS listovi za testere za drvo, brzo sečenje



Model	Tip noža	Radna dužina (mm)	Broj zuba na colu	Mekano/tvrdo drvo (mm)	Plastika (mm)	Jedinica (kom/kompl)	Cena sa PDV-om	
A-85232	B-8	75	8	4-65	4-65	5/1		
A-85684	B-16	75	6	5-65	5-65	5/1		
A-85690	B-17	71	6	5-60	5-60	5/1		
A-86309	L-2	101	6	5-90	5-90	5/1		
A-86315	L-10	151	6	5-135	5-135	5/1		
A-86577	58	75	8	4-65	4-65	5/1		
D-34883	B-16	74	6	4-50	4-50	5/1		
D-34899	/	74	6	4-50	4-50	5/1		

 Akumulat  
ori i  
punjači

 Pribor za  
akumulat  
orske  
alate

 Akumulat  
orske  
lampe i  
pribor

 Pribor za  
laserske  
merace

 Pribor za  
rušenje i  
udarno  
bušenje

 Pribor za  
bušenje

 Krunaste  
testere

 Pribor za  
pritezani  
e

 Pribor za  
sečenje i  
brusjenje

 Pribor za  
brusjenje  
i  
poliranje

 Pribor za  
profilisanje  
i  
poravnane

 Pribor za  
višenam  
enski alati

 Pribor za  
testere

 Pribor za  
pneumat  
ske alate

 Pribor za  
fenove  
za vrući  
vazduh

 Pribor za  
usisivanje

 Pribor za  
alate za  
rad na  
otvoreno

 Pribor za  
držače  
alata i  
zaštitna

 Koferi i  
torbe

 Ručni  
alati

Ostalo

 Pribor za  
mješanje

# Pribor za testere

## HSS listovi za testere za metal, univerzalno sečenje



	Model	Tip noža	Radna dužina (mm)	Broj zuba na colu	Aluminijum (mm)	Plastika (mm)	Nerdajući čelik (mm)	Čelik/Mekani čelik (mm)	Jedinica (kom/kompl)	Cena sa PDV-om
	A-85721	B-21	73	12	1-10	3-60			5/1	
	A-85737	B-22	52	24	1-3	1-6	1-3	1-3	5/1	
	A-85743	B-23	51	14	2-6	3-35	2-6	2-6	5/1	
	A-85759	B-24	52	32	1-2	1-3	0,5-2	0,5-2	5/1	
	A-85771	B-26	71	9	3-10	3-60	3-10	3-10	5/1	
	A-85787	B-27	52	24	1-3	1-6	1-3	1-3	5/1	
	B-04961	B-30	50	24	1-3	1-6	1-3	1-3	5/1	
	D-34908	B-22	51	21	1-3			1-3	5/1	

## BiM listovi za testere za laminat



	Model	Tip noža	Radna dužina (mm)	Broj zuba na colu	Laminati (mm)	Sečenje po krivnoj	Fino sečenje	Jedinica (kom/kompl)	Cena sa PDV-om
	B-10970	B-53	59	15	1,5-15		•	5/1	
	B-10986	B-54	59	18	1,5-15	•	•	5/1	
	B-31887	B-55	77	15	2-30		•	5/1	

## Listovi za testere od tvrdog metala za fiberglas



	Model	Radna dužina (mm)	Korak zuba (mm)	Fiberglas (mm)	Sečenje po krivnoj	Debeli materijali	Pogodno za	Jedinica (kom/kompl)	Materijal lista	Cena sa PDV-om
	P-38766	75	4,2		•	•	ojačana staklena vlakna	3/1	HM	
	P-38788	54	/	1-15	•		obojeni metal, FRP, PVC	3/1		





## Specijalizovani listovi za testere za razne materijale



	Model	Tip noža	Materijal lista	Radna dužina (mm)	Broj zuba na colu	Pogodno za	Jedinica (kom/kompl)	Cena sa PDV-om
	A-80416	B-K	HCS	75		papir, pluta, guma, koža	5/1	
	A-85765	B-25	HSS	74	9	tvrd drvo, drvo sa ekserima, žilava plastika, metal, obojeni metal	5/1	
	B-06890	B-60	HM	75	6	gips ploče 5-50 mm, FRP/ plastika 5-20 mm	3/1	

Nastavak...



# Pribor za testere

Model	Tip noža	Materijal lista	Radna dužina (mm)	Broj zuba na colu	Pogodno za	Jedinica (kom/kompl)	Cena sa PDV-om	
B-06909	B-61	HM	105	6	gips ploče 5-80 mm, FRP/ plastika 5-50 mm	3/1		
P-05929	/	HM	50	24	limovi i nerđajući čelik	1		
P-47204	/	Bi-Metal	105	24	izolacije, sendvič panel, metal	5/1		
P-49622	/	Bi-Metal	75	10	drvo sa ekserima, metal	5/1		
P-49644	/	Bi-Metal	155	24	debele obloge	5/1		

## Listovi za testere Super Express, super brzo sečenje

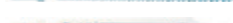

Revolucionarna snaga sečenja „Super Express listovi“ se karakterišu sa progresivnim zupcima što znači da mogu lako da seku mnogo tanke materijale, kao i debele. Makita Super Express listovi su tanki - tako da proizvode mnogo brzo sečenje i izuzetan kvalitet. Oni su idealni za akumulatorske testere, gde njihov tanak oblik znači manje trošenje akumulatora - i više sečenja pri punjenju.



Model	Tip noža	Materijal lista	Radna dužina (mm)	Broj zuba na colu	Aluminijum (mm)	Plastika (mm)	Nerđajući čelik (mm)	Jedinica (kom/kompl)	Cena sa PDV-om	
B-06460	B-50	HCS	73	8,5-10,6		5-50		5/1		
B-06476	B-51	HSS	73	9,8-18,1	1-10	1-3	1-3	5/1		
B-06482	B-52	HSS	73	5,5-9,8	3-35	3-35	3-8	5/1		

## Komplet raznih listova za testere



Model	Naziv	Tip noža	Materijal lista	Ukupna dužina (mm)	Jedinica (kom/kompl)	Cena sa PDV-om	
A-86898	List za ubodnu testeru	B-13, B-16, B-22, B-23, B-10S	HCS, HSS		5/1		
B-06292	10-delni set listova za ubodnu testeru	B-50, B-51, B-52	HSS		3/1		
B-44426	10-delni set listova testere	4x B-50, 2x (B-51, B-52, B-53)	HCS, HSS	2x 82 mm, 8x 100 mm	10/1		

Akumulatori i punjači  
 Pribor za akumulatorske testere  
 Akumulatorske lampe i pribor  
 Pribor za laserske merace  
 Pribor za rušenje i udarno bušenje  
 Pribor za bušenje  
 Krunaste testere  
 Pribor za pritezanje  
 Pribor za sečenje i bušenje  
 Pribor za brušenje i poliranje  
 Pribor za profilisanje i poravnanje  
 Pribor za višenamenski alat  
 Pribor za testere  
 Pribor za pneumatske alate  
 Pribor za fenove za vrući vazduh  
 Pribor za usisivanje  
 Pribor za alate za rad na otvoreno  
 Pribor za držače alata i zaštitna  
 Koferi i torbe  
 Ručni alati  
 Ostalo  
 Pribor za mješanje







## Kompleti listova za testeru - 100 kom.









	Model	Tip noža	Materijal lista	Radna dužina (mm)	Korak zuba (mm)	Broj zuba na colu	Pogodno za	Jedinica (kom/kompl)	Cena sa PDV-om
	B-07674	B-10	HCS	76	2,9	9	drvo	100/1	
	B-07680	B-11	HCS	73	2,8	9	drvo	100/1	
	B-07696	B-12	HCS	74	4,2	6	drvo	100/1	
	B-07705	B-13	HCS	70	3,2	8	drvo	100/1	
	B-07727	B-18	HCS	44	1,8	14	drvo	100/1	
	B-07733	B-22	HSS	52	1,1	24	metal	100/1	
	B-07749	B-23	HSS	51	1,8	14	metal	100/1	
	B-07755	B-25	HSS	74	2,8	9	drvo	100/1	
	B-07761	B-29	HCS	44	1,6	77	drvo	100/1	
	B-07777	BR-13	HCS	70	2,8	90	drvo	100/1	
	B-07783	No.1	HSS	61	1,1	24	metal	100/1	
	B-07799	No.2	HSS	60	1,8	14	drvo	100/1	

[Nastavak...](#)

# Pribor za testere

Model	Tip noža	Materijal lista	Radna dužina (mm)	Korak zuba (mm)	Broj zuba na colu	Pogodno za	Jedinica (kom/kompl)	Cena sa PDV-om	
B-07808	No.3	HCS	59	2,8	9	drvo	100/1		
B-07814	No.8	HCS	60	3,2	8	drvo	100/1		
B-07820	Nr.10	HCS	60	2,9	9	drvo	100/1		
B-07836	No.51	HSS	66	1,1	24	metal	100/1		
B-07842	No.58	HCS	75	2,9	9	drvo	100/1		
B-07858	No.59	HCS	75	3,2	8	drvo	100/1		





# Pribor za ubodne testere

Model	Naziv	Za model	Cena sa PDV-om	
123030-5	Kružna vodica	4300BA, 4300BV		
164113-2	Vodica	4300BV, JV2000		
192557-6	Uređaj protiv pucanja materijala	DJV184		
192561-5	Kružna vodica	4304T,4331,4333		
192732-4	Vodica	JV100D, JV101D, JV102D, JV103D, JV143D, JV183D, 4326/M, 4327/M, 4328, 4329, JV0600, DJV184		
193516-3	Vodica	DJV141, DJV142, DJV180, DJV181, DJV182, 4350T/CT/FCT, 4351T/CT/FCT		

Nastavak...

- Akumulat orni i punjači
- Pribor za akumulat orske alat
- Akumulat orske lampe i pribor
- Pribor za laserske merace
- Pribor za rušenje i udarno bušenje
- Pribor za bušenje
- Krunaste testere
- Pribor za pritezanje
- Pribor za sečenje i brusenje
- Pribor za brusenje i poliranje
- Pribor za profilisanje i poravnanje
- Pribor za višenamenski alat
- Pribor za testere
- Pribor za pneumatike alat
- Pribor za fenove za vrući vazduh
- Pribor za usisivanje
- Pribor za alat na otvoreno
- Pribor za držače alata i zaštitna
- Koferi i torbe
- Ručni alati
- Ostalo
- Pribor za mješanje









# Pribor za testere

	Model	Naziv	Za model	Cena sa PDV-om
	197252-3	Adapter za vodicu (A, B, JV)	DHS630, DHS710, HS7101, HS6101, 4350CT, 4350FCT, 4351CT, 4351FCT, DJV180, DJV181, DJV182	
	415524-7	Uredaj protiv pucanja materijala	4329, 4340CT, 4340FCT, 4341CT, 4341FCT, 4350CT, 4350FCT, 4351CT, 4351FCT, DJV180, DJV181, DJV182, JV103	
	416477-3	Uredaj protiv pucanja materijala	4323	
	417852-6	Poklopac	4350CT, 4350FCT, 4351CT, 4351FCT, DJV180, DJV181, DJV182, DJV184	
	458191-5	Štitnik za prašinu	DJV184	

## Listovi za sabljaste testere

### Listovi za testere za drvo



	Model	Materijal lista	Debljina lista (mm)	Ukupna dužina (mm)	Broj zuba na colu	Mekano/tvrdo drvo (mm)	Plastika (mm)	Drvo sa ekserima (mm)	Jedinica (kom/kompl)	Cena sa PDV-om
	B-03030	HCS	1,25	300	6	5-250	135-280		5/1	
	B-05175	Bi-Metal	1,25	152	6	50-100	5-135	10-100	5/1	
	B-31843	Bi-Metal	0,9	152	10	5-100		5-100	5/1	
	B-31859	Bi-Metal	0,9	225	10	5-175		5-175	5/1	
	P-04999	HSS	0,9	150	4	8-100	0-100		5/1	
	P-05000	HSS	0,9	150	10	5-100			5/1	
	P-05016	HCS	0,9	300	6	6-250	6-250		5/1	
	P-05022	HSS	0,9	150	6	6-100	6-100		5/1	
	P-05072	HSS	1,27	300	4-6,5	3-250			5/1	

# Pribor za testere

## Listovi za testere za metal



Model	Materijal lista	Ukupna dužina (mm)	Debljina lista (mm)	Broj zuba na colu	Aluminijum (mm)	Čelik/ Mekani čelik (mm)	Nerđajući čelik (mm)	Jedinica (kom/ kompl)	Cena sa PDV-om	
B-05169	Bi-Metal	152	0,9	18	1,5-3	1,5-4		5/1		
B-05169-2	Bi-Metal	152	0,9	18	1,5-3	1,5-4		2/1		
B-05169-25	Bi-Metal	152	0,9	18	1,5-3	1,5-4		25/1		
B-16776	Bi-Metal	225	0,9	14		3-8		5/1		
B-16776-2	Bi-Metal	225	0,9	14		3-8		2/1		
B-16776-25	Bi-Metal	225	0,9	14		3-8		25/1		
B-16782-25	Bi-Metal	228	0,9	18		1,5-4		25/1		
B-16841-25	Bi-Metal	152	0,9	14		3-8		25/1		
B-16857	Bi-Metal	305	0,9	10-14	5-20	5-20		5/1		
B-16857-2	Bi-Metal	305	0,9	10-14	5-320	5-20		2/1		
B-43175	Bi-Metal	225	1,1	14-18		0,7-3		5/1		
B-55815	Bi-Metal	152	1,1	14-18		3-8		5/1		
B-55821	Bi-Metal	228	1,1	14-19		3-8		5/1		
B-55837	Bi-Metal	305	1,1	14-20		3-8		5/1		
P-04874	Bi-Metal	100	0,9	18		1,5-2,5	1,5-3	5/1		
P-04880	Bi-Metal	150	0,9	18		1,5-2,5	1,5-3	5/1		
P-04896	Bi-Metal	100	0,9	24	1-6	1,2-2	1,5-3	5/1		
P-04905	Bi-Metal	150	0,9	24	1,5-4	1,2-3	1,2-3	5/1		
P-04911	Bi-Metal	150	0,9	14		2,5-3,5		5/1		
P-04927	Bi-Metal	200	0,9	14	1,2-3,5	2,5-3,5	1,2-3,5	5/1		
P-04933	Bi-Metal	200	0,9	18		1,5-3	1,5-3	5/1		
P-04949	Bi-Metal	200	0,9	24	1,5-3	1,2-3	1,2-2	5/1		
P-04955	Bi-Metal	150	0,9	32	1,2-3,5	1,2	0,5-1	5/1		
P-04983	Bi-Metal	280	0,9	10	3,5-5	3,5-5	3,5-5	5/1		
P-05088	Bi-Metal	150	1,27	6				5/1		

## Listovi za testere za građevinske materijale



Model	Materijal lista	Debljina lista (mm)	Ukupna dužina (mm)	Broj zuba na colu	Eternit, liveno gvožđe (mm)	Siprek, cigla (mm)	Penljivi beton, poliuretanska pena (mm)	Drvo sa ekserima (mm)	Cena sa PDV-om	
B-10394	HM	1,5	305	2		0-215				
B-10403	HM	1,5	455	2		0-365				
B-49834	TC/HM	1,25	152	6-8				5-100		
B-49834-10	TC/HM	1,25	152	6-8				5-100		
B-49840	TC/HM	1,25	228	6-8				5-175		
B-49840-10	TC/HM	1,25	228	6-8				5-175		
B-49856	TC/HM	1,25	305	6-8				5-250		

Nastavak...

Akumulat  
ori i  
punjači

Pribor za  
akumulat  
orske  
lampe i  
orske  
prilob

Akumulat  
orske  
lampe i  
prilob

Pribor za  
laserske  
merace

Pribor za  
rušenje i  
udarno  
bušenje

Pribor za  
bušenje

Krunaste  
testere

Pribor za  
pritzanje  
e

Pribor za  
sečenje i  
bušenje

Pribor za  
bušenje  
i  
poliranje

Pribor za  
profilisanje  
e i  
poravnaj

Pribor za  
višenam  
e i  
eniski alat

Pribor za  
testere

Pribor za  
pneumat  
ske alate

Pribor za  
fenove  
za vrući  
vazduh

Pribor za  
usisivanj  
e

Pribor za  
alate za  
rad na  
otvoreno





Pribor za  
držače  
alata i  
zaštitna

Koferi i  
torbe



Ručni  
alati

Ostalo

Pribor za  
mješanje

	Model	Materijal lista	Debljina lista (mm)	Ukupna dužina (mm)	Broj zuba na colu	Eternit, liveno gvožđe (mm)	Siporek, cigla (mm)	Penjivi beton, poliuretanska pena (mm)	Drvo sa ekserima (mm)	Cena sa PDV-om
	B-49856-10	TC/HM	1,25	305	6-8				5-250	
	P-05038	HM	1,3	90	6	0-75	0-75	0-75		
	P-05044	HM	1,3	150	6	0-130	0-130	0-130		
	P-05050	HM	1,3	300	6	0-280	0-280	0-280		
	P-05066	HM	1,3	400	3	0-380	0-380	0-380		

## Specijalizovani listovi za testere za razne materijale

	Model	Materijal lista	Ukupna dužina (mm)	Debljina lista (mm)	Broj zuba na colu	Pogodno za	Jedinica (kom/kompl)	Cena sa PDV-om
	B-55566	TC/HM	100	1,25	8	Metal, liveno gvožđe, nerđajući čelik	1	
	B-07250	TC/HM	152	1,0	18	Nerđajući čelik 2-4mm, cevi od nerđajućeg čelika do 80mm, fiberglas	2/1	
	B-55572	TC/HM	152	1,25	8	Metal, liveno gvožđe, nerđajući čelik	1	
	B-56580	HCS	190	0,6	8,5	grane prečnika do 100mm devo do prečnika 100mm	1	
	B-56596	HCS	190	0,6	15	za bambus prečnika do 100mm, drvo prečnika do 100mm PVC prečnika do 100mm	1	
	B-51312	TC/HM	203	1,0	18	Nerđajući čelik 2-4mm, cevi od nerđajućeg čelika do 150mm, fiberglas	2/1	
	B-52118	HCS	225	1,5	18	Izolacioni materijal, staklena vuna, kamena vuna	2/1	
	B-57386	BiM	225	0,9	8,5	meko drvo	1	
	B-57392	BiM	225	0,9	15	za bambus prečnika do 100mm, drvo prečnika do 100mm PVC prečnika do 100mm	1	
	B-31871	diamond grit	228	1,0		Cevi od livenog gvožđa do 150 mm, opeka 10-175 mm, FRP/epoxy 3-175 mm	2/1	
	B-55588	TC/HM	228	1,25	8	Metal, liveno gvožđe, nerđajući čelik	1	
	B-62016	HCS	250	0,9	8,5	grane prečnika do 160 mm, bambus prečnika do 160 mm	1	
	B-52124	HCS	300	1,5		Izolacioni materijal, staklena vuna, kamena vuna	2/1	
	B-55594	TC/HM	305	1,25	8	Metal, liveno gvožđe, nerđajući čelik	1	
	B-63585	HM	305	1,5	3	porobeton, vatrogasna opeka, pešćar, gips	1	
	B-52130	HCS	400	1,5		Izolacioni materijal, staklena vuna, kamena vuna	1	

Nastavak...











# Pribor za testere

Model	Materijal lista	Ukupna dužina (mm)	Debljina lista (mm)	Broj zuba na colu	Pogodno za	Jedinica (kom/ kompl)	Cena sa PDV-om	
B-63591	HM	400	1,5	2	porobeton, vatrogasna opeka, pešćar, gips	1		

## Listovi za testere Super Express, super brzo sečenje

Revolucionarna snaga sečenja. „Super Express listovi“ se karakterišu sa progresivnim zupcima što znači da mogu lako da seku mnogo tanke materijale, kao i debele. Makita Super Express listovi su tanki - tako da proizvode mnogo brzo sečenje i izuzetan kvalitet. Oni su idealni za akumulatorske testere, gde njihov tanak oblik znači manje trošenje akumulatora - i više sečenja pri punjenju.



Model	Materijal lista	Ukupna dužina (mm)	Debljina lista (mm)	Broj zuba na colu	Pogodno za	Jedinica (kom/ kompl)	Cena sa PDV-om	
B-05038	Bi-Metal	152	0,9	7-18	brzo rezanje metala(gvožđe/čelik) 1,5-8mm, aluminijuma 1-10mm, plastike 5-77mm	5/1		
B-05038-2	Bi-Metal	152	0,9	7-18	brzo rezanje metala(gvožđe/čelik) 1,5-8mm, aluminijuma 1-10mm, plastike 5-77mm	2/1		
B-05038-25	Bi-Metal	152	0,9	7-18	brzo rezanje metala(gvožđe/čelik) 1,5-8mm, aluminijuma 1-10mm, plastike 5-77mm	25/1		
B-05044	Bi-Metal	152	0,9	6-11	brzo rezanje obojenih metala (gvožđe/čelik/ aluminijum) 5-8mm, plastike 5-77mm i drveta 5-77mm	5/1		
B-05044-2	Bi-Metal	152	0,9	6-11	brzo rezanje obojenih metala (gvožđe/čelik/ aluminijum) 5-8mm, plastike 5-77mm i drveta 5-77mm	2/1		
B-05044-25	Bi-Metal	152	0,9	6-11	brzo rezanje obojenih metala (gvožđe/čelik/ aluminijum) 5-8mm, plastike 5-77mm i drveta 5-77mm	25/1		
B-05153	HCS	203	1,0	6-10	brzo rezanje drveta 5-150mm, plastike 5-150mm, šper ploče/furnira 6-60mm	5/1		
B-05153-2	HCS	203	1,0	6-10	brzo rezanje drveta 5-150mm, plastike 5-150mm, šper ploče/furnira 6-60mm	2/1		
B-05153-25	HCS	203	1,0	6-10	brzo rezanje drveta 5-150mm, plastike 5-150mm, šper ploče/furnira 6-60mm	25/1		

Akumulatori i punjači

Pribor za akumulatorske testere

Akumulatorske lampe i pribor

Pribor za laserske merace

Pribor za rušenje i udarno bušenje

Pribor za bušenje

Krunaste testere

Pribor za pritzanije

Pribor za sečenje i brušenje

Pribor za brušenje i poliranje

Pribor za profilisanje i poravnavanje

Pribor za višenamenski alat

Pribor za testere

Pribor za pneumatske alate

Pribor za fenove za vrući vazduh

Pribor za usisivanje

Pribor za alate za rad na otvoreno

Pribor za držače alata i zaštitna

Koferi i torbe

Ručni alati

Ostalo

Pribor za mješanje

## Listovi za testere za smrznute materijale



Model	Materijal lista	Ukupna dužina (mm)	Debljina lista (mm)	Broj zuba na colu	Pogodno za	Cena sa PDV-om
B-10609	nerđajući čelik	305	1,25	3	led/zamrznut materijal 10-250 mm	
B-23248	nerđajući čelik	300	1,2	6	led/zamrznut materijal 10-250 mm	
B-23254	nerđajući čelik	300	1,2	10	led/zamrznut materijal 10-250 mm	
B-30564	nerđajući čelik	228	1,2	6	led/smrznuti materijal 10-175 mm	
B-30570	nerđajući čelik	228	1,2	10	led/smrznuti materijal 10-175 mm	

## Komplet raznih listova za testere

	Model	Naziv	Materijal lista	Tip noža	Ukupna dužina (mm)	Debljina lista (mm)	Jedinica (kom/kompl)	Cena sa PDV-om
	792003-5	Set listova za sabljastu testeru	HCS, HSS	B-00804, B-00810, B-00826	125, 2x165	0,9, 0,9, 1,0	3/1	
	B-13677	List za ubodnu testeru	Bi-Metal, HCS	B-05038, B-05044, B-05153	152, 152, 203	0,9, 0,9, 1,0	3/1	
	B-44432	Set listova za sabljastu testeru	Bi-Metal, HCS	2x (B-16798, B-05175, B-05153)	4x 152, 2x 203 mm	1,0 / 1,25 / 1,25	6/1	
	B-44448	Set listova za sabljastu testeru	Bi-Metal	2x (B-05044, B-16776, B-16782)	2x 152, 4x 225	0,9	6/1	





## Listovi za testere za JR100D

	Model	Materijal lista	Ukupna dužina (mm)	Broj zuba na colu	Pogodno za	Jedinica (kom/kompl)	Cena sa PDV-om
	B-20432	Bi-Metal	100	6	tvrdno drvo, drvo sa ekserima	5/1	
	B-20448	Bi-Metal	100	6	gips ploče	5/1	
	B-20454	Bi-Metal	100	14-18	drvo i metal	5/1	

# Pribor za testere

243

## Pribor za JR100D/JR1000FTK

Model	Naziv	Ukupna dužina (mm)	Radna dužina (mm)	Za model	Jedinica (kom/kompl)	Cena sa PDV-om	
A-40945	Turpija za metal/ okrugli tip	153	60	JR1000FTK	3/1		
A-40967	Adapter za brušenje	153	90	JR1000FTK	1		
B-04977	Brusna hartija za drvo	/	95 x 22	JR1000FTK	10/1		
B-04983	Brusna hartija Velcro za drvo	/	95 x 22	JR1000FTK	10/1		

## Tračne testere



## Listovi za testere

Model	Materijal lista	Dužina lista testere (mm)	Širina lista testere (mm)	Najveći kapacitet sečenja (mm)	Broj zuba na colu	Pogodno za	Za model	Jedinica (kom/kompl)	Cena sa PDV-om
194692-6	HSS	1.140	13	< 4	24	plastika i obojeni metali, meki čelik, liveni čelik, tvrdi čelik, nerdajući čelik	2106, 2107FK, DPB180, PB002G	1	
792556-4	HSS	1.140	13	4-5	18	plastika i obojeni metali, meki čelik, liveni čelik, tvrdi čelik, nerdajući čelik	2106, 2107FK, DPB180, PB002G	1	
792557-2	HSS	1.140	13	> 5	14	plastika i obojeni metali, meki čelik, liveni čelik, tvrdi čelik, nerdajući čelik	2106, 2107FK, DPB180, PB002G	1	
792558-0	ugljeni nerdajući čelik	1.140	13	< 4	24	plastika i obojeni metali, meki čelik, liveni čelik i nerdajući čelik	2106, 2107FK, DPB180, PB002G	3/1	
792559-8	ugljeni nerdajući čelik	1.140	13	4-5	18	plastika i obojeni metali, meki čelik, liveni čelik i nerdajući čelik	2106, 2107FK, DPB180, PB002G	3/1	
792560-3	ugljeni nerdajući čelik	1.140	13	> 5	14	plastika i obojeni metali, meki čelik, liveni čelik i nerdajući čelik	2106, 2107FK, DPB180, PB002G	3/1	
792567-9	ugljeni nerdajući čelik	1.140	13	/	6	drvo	2106, 2107FK, DPB180, PB002G	3/1	
B-30128	BiM	1.140	13	> 6	10	limovi i nerdajući čelik	2106, 2107FK, DPB180, PB002G		
B-40543	BiM	835	13	3-6	14	plastika i obojeni metali, meki čelik, liveni čelik, tvrdi čelik, nerdajući čelik	DPB181, DPB182, DPB183	5/1	
B-40559	BiM	835	13	2-3	18	plastika i obojeni metali, meki čelik, liveni čelik, tvrdi čelik, nerdajući čelik	DPB181, DPB182, DPB183	5/1	
B-40565	BiM	835	13	< 2	24	plastika i obojeni metali, meki čelik, liveni čelik, tvrdi čelik, nerdajući čelik	DPB181, DPB182, DPB183	5/1	
E-04101	BiM	730	13	3-6	14	metal	DPB184	5/1	
E-04117	BiM	730	13	2-3	18	metal	DPB184	5/1	

Nastavak...

Akumulat  
ori i  
punjači

Pribor za  
akumulat  
orske  
slike

Akumulat  
orske  
lampe i  
pribor

Pribor za  
laserske  
merace

Pribor za  
rušenje i  
udarno  
bušenje

Pribor za  
bušenje

Krunaste  
testere

Pribor za  
pritazanj  
e

Pribor za  
sečenje i  
brušenje

Pribor za  
brušenje  
i  
poliranje

Pribor za  
profilisanj  
e i  
poravnaj

Pribor za  
višenam  
enski alat

Pribor za  
testere

Pribor za  
pneumat  
ske alate

Pribor za  
fenove  
za vrući  
vazduh

Pribor za  
usisivanj  
e

Pribor za  
alate za  
rad na  
otvoreno

Pribor za  
držače  
alata i  
zaštitna

Koferi i  
torbe

Ručni  
alati

Ostalo

Pribor za  
mješanje

Model	Materijal lista	Dužina lista testere (mm)	Širina lista testere (mm)	Najveći kapacitet sečenja (mm)	Broj zuba na colu	Pogodno za	Za model	Jedinica (kom/kompl)	Cena sa PDV-om
E-04123	BIM	730	13	< 2	24	metal	DPB184	5/1	
B-16673	HCS	2.240	13	/	4	drvo	LB1200F	3/1	
B-16689	HCS	2.240	6	/	6	drvo	LB1200F	3/1	
B-16695	HCS	2.240	16	/	14	metal	LB1200F	3/1	
JM21080294	/	2.240	6	/	6	drvo	LB1200F	1	
JM21080295	/	2.240	13	/	4	drvo	LB1200F	1	
JM21080296	/	2.240	16	/	4	drvo	LB1200F	1	
JM21080297	/	2.240	16	/	14	metal	LB1200F	1	

## Ostali pribor

	Model	Naziv	Za model	Cena sa PDV-om
	194069-5	Postolje za tračnu testeru	2106, 2107FK, DPB180	
	194070-0	Komplet poklopca za disk	2106, 2107FK, DPB180	
	197975-3	Komplet poklopca za disk	DPB181, DPB182	
	JM21000300	Radni sto	LB1200F	
	JM21000320	Dodatak za kružno sečenje	LB1200F	
	JM21000330	Dodatak za brušenje	LB1200F	
	JM21080230	Paralelni naslon sklop	LB1200F	
	JM21080260	Uglomer za koso sečenje sklop	LB1200F	
	JM21080290	Letva za guranje	LB1200F, LH1200FL	
	191897-9	Vosak za stonu tračnu testeru	LC1230, 2106, 2107FK, DPB180, DPB181, DPB182, DPB183, DPB184	

Nastavak...

# Pribor za testere

245

Model	Naziv	Za model	Cena sa PDV-om	
JM23300008	Paralelni naslon sklop	LH1200FL		

## Lančani sekač

### Pribor

Model	Naziv	Širina sečenja (mm)	Za model	Cena sa PDV-om	
A-16570	Lanac za kopanje	16,5	7104L		
A-16586	Lanac za kopanje	18	7104L		
A-16592	Lanac za kopanje	21	7104L		
A-16601	Lanac za kopanje	24	7104L		
P-22084	Lanac za kopanje	40	KC100		
P-22090	Lanac za kopanje	50	KC100		
P-22109	Vodilica sa lančanicom	30	KC100		
P-22115	Vodilica sa lančanicom	40	KC100		
P-22121	Vodilica sa lančanicom	50	KC100		
P-22137	Lančanik	30	KC100		
P-22143	Lančanik	40	KC100		

Akumulat  
ori i  
punjači

Pribor za  
akumulat  
orske  
alate

Akumulat  
orske  
lampe i  
pribor

Pribor za  
laserske  
merace

Pribor za  
rušenje i  
udarno  
bušenje

Pribor za  
bušenje

Krunaste  
testere

Pribor za  
pritezani  
e

Pribor za  
sečenje i  
brusenje

Pribor za  
brusenje  
i  
poliranje

Pribor za  
profilisanj  
e i  
poravnaj

Pribor za  
višenam  
enski alat

Pribor za  
testere

Pribor za  
pneumat  
ske alate

Pribor za  
fenove  
za vrući  
vazduh

Pribor za  
usisivanj  
e

Pribor za  
alate za  
rad na  
otvoreno

Pribor za  
držače  
alata i  
zaštitna

Koferi i  
torbe

Ručni  
alati

Ostalo

Pribor za  
mješanje

## Ostali pribor za sečenje testerom

## Letve vodice i pribor



Model	Dužina	Torba
199140-0	1,0 m	E-05670
199141-8	1,5 m	E-05664
194925-9	1,9 m	E-10920
194367-7	3,0 m	E-10936

## Stega



Model	Naziv	Jedinica (Kom/kompl)
194385-5	Komplet stega	2/1
199826-6	Set bravarskih stega	2/1
198885-7	Set za spajanje vodica	2/1

## Ugaonik



Model	Naziv	Razpon
196664-7	Podesivi ugaonik za vodice	0 - 180°

## Trake za vodice

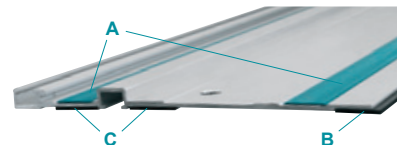

Model	Naziv	Tip	Dužina
413101-9	Klizna guma	A	1,4 m
413102-7	Klizna guma	A	3,0 m
194416-0	Klizna guma	A	10,0 m
423359-2	Vodeća traka	B	1,4 m
423360-7	Vodeća traka	B	3,0 m
423361-5	Traka za stabilnost	C	1,4 m
423362-3	Traka za stabilnost	C	3,0 m
194417-8	Traka za stabilnost	C	10,0 m

## Paralelna vodica











Model	Za model
165153-3*	DRS780, RS001G, RS002G
164367-1	HS0600, N5900B
165447-6*	DSP600, DSP601, SP6000
165084-6	5103R, 5104S, 5903R
164021-7	5800BR, 5900BR
164095-8*	4131, 5008MG, DCS552, DCS553, DHS630, DHS660, DHS680, DHS710, HS301D, HS7101, HS7601, HS7611, M5802
165108-8	5017RKB, 5603R, 5705R
152498-8	5143R

\*Leptir šaraf - 265701-9



## Ostali pribor za sečenje testerom

## Radni stolovi

	Model	Naziv	Dimenzije (D x Š x V) (mm)	Za model	Cena sa PDV-om
	194093-8	Postolje za stabilne testere	655 x 810 x 630	2704	
	198687-1	Postolje za stabilne testere WST01N	2.750 x 660 x 840	LS0713, DLS713, LS1040, LS1440, MT230, MLS100, LS1213, LS1016, LS1216, LS1018	
	198688-9	Postolje za stabilne testere	740 x 750 x 835	LS1019L	
	198689-7	Postolje za diht	170 x 1.055 x 790	2012NB	
	DEAWST05	Postolje za stabilne testere	2.700 x 500 x 800/500	LS0714FB, LS1016, LS1018L, LS1019, LS1040F, LS1216, LS1440, LH1040, LH1200, MLS100, DLS211, LS003G	
	DEAWST07	Postolje za stabilne testere	3.830/1765 x 750 x 860	Not for DLS600, LH1040F, LH1201FL	
	DEBWST06	Postolje za stabilne testere	2.550/1.150 x 750 x 850	LS0714FB, LS1016, LS1018L, LS1019, LS1040F, LS1216, LS1440, MLS100, LS003G	
	JM27000300	Postolje za stabilne testere	1.015 x 590 x 560	MLT100N, 2702, 2703	

## Pribor za testere

	Model	Naziv	Za model	Jedinica (kom/kompl)	Cena sa PDV-om
	122536-0	Vertikalna stega	LH1040/F, LS1040/F	1	
	122538-6	Vertikalna stega	LS1013/F/L	1	

[Nastavak...](#)

















# Pribor za testere

Model	Naziv	Za model	Jedinica (kom/kompl)	Cena sa PDV-om	
122540-9	Vertikalna stega	LS1214/L/F	1		
122556-4	Vodica	2702	1		
122563-7	Horizontalna stega	DLS713, LS0714/FL, LH1040/F, LS1040/F, DLS211, LS002G	1		
122571-8	Vertikalna stega	DLS713, DLS714, LS0714, LS0714FL, LS1214, LS1214FL	1		
122707-9	Vodica	LH1040/F, LS1040	1		
122728-1	Vertikalna stega	LF1000	1		
122729-9	Granična vodica	LF1000	1		
122731-2	Gornji štitnik	LF1000	1		
122739-6	Vodica	2704	1		
122740-1	Paralelni naslon sklop	2704	1		
122854-6	Vertikalna stega	LS1216L, LS1016L	1		
122930-6	Stega	LS1216L, LS1018L	1		
123101-8	Držač	LS1040/F, DLS713	1		
126617-2	Vertikalna stega	LS1019L, DLS211, LS003G	1		
127069-0	Uglomer za koso sečenje sklop	2704	1		

Nastavak...

- Akumulat orni i punjači
- Pribor za akumulat orske alate
- Akumulat orske lampe i pribor
- Pribor za laserske merace
- Pribor za rušenje i udarno bušenje
- Pribor za bušenje
- Krunaste testere
- Pribor za pritezanje
- Pribor za sečenje i brušenje
- Pribor za brušenje i poliranje
- Pribor za profilisanje i poravnavanje
- Pribor za višenamenski alat
- Pribor za testere**
- Pribor za pneumat ske alate
- Pribor za fenove za vrući vazduh
- Pribor za usisivanje
- Pribor za alate za rad na otvoreno
- Pribor za držače alata i zaštitna
- Koferi i torbe
- Ručni alati
- Ostalo
- Pribor za mješanje

	Model	Naziv	Za model	Jedinica (kom/kompl)	Cena sa PDV-om
	153896-9	Desni pomoćni naslon	LS1013/L/F, LS1214/F/L	1	
	191U61-8	Postolje	LS004G	1	
	192625-5	Vertikalna stega	LH1040	1	
	192628-9	Graničnik sa krunastim profilom	LS1013, LS1019/L, LS1214, LS003G	2/1	
	193730-1	fluo-cev za osvetljenje	2107F, LS0714, LS1013, LS1040F, LS1214F	1	
	194086-5	Levi produžni sto	2704	1	
	194087-3	Produžni sto nazad	2704	1	
	194241-9	Klizna vođica	2704	1	
	195253-5	Graničnik sa krunastim profilom	LS1216L, DLS211	1	
	322932-4	Nastavak za držač	LS1013/F/L, LS1214/F/L	1	
	JM00000219	Set za montažu za WST07	WST07, WST06	2/1	
	JM21080290	Letva za guranje	LB1200F, LH1200FL		
	JM23000127	Držač komplet	MLS100, LS0815	1	
	JM23000131	Vertikalna stega	MT230	1	
	JM23100500	Nastavak za držač	LS1018L, LH1200FL	1	

Nastavak...

# Pribor za testere

Model	Naziv	Za model	Jedinica (kom/kompl)	Cena sa PDV-om	
JM23100502	Stega	LS1018L, LH1200FL	1		
JM23610050	Set za montažu za WST06	WST06	2/1		
JM27000046	Zadnji radni sto-produžetak	MLT100	1		
JM27000068	Desni radni sto-produžetak	MLT100	1		
JM27000201	Paralelni naslon sklop	MLT100	1		
JM27000202	Paralelni naslon sklop	MLT100X	1		
JM27000224	Uglomer za koso sečenje sklop	MLT100X	1		
JM27000328	Trougla ploča	MLT100, LS1018L, LH1200L	1		

Akumulat  
ori i  
punjači

Pribor za  
akumulat  
orske  
alate

Akumulat  
orske  
lampe i  
pribor

Pribor za  
laserske  
merace

Pribor za  
rušenje i  
udarno  
bušenje

Pribor za  
bušenje

Krunaste  
testere

Pribor za  
pritezanj  
e

Pribor za  
sečenje i  
brusenje

Pribor za  
brusenje  
i  
poliranje

Pribor za  
profilisanj  
e i  
poravnav

Pribor za  
višenam  
enski alat

**Pribor za  
testere**

Pribor za  
pneumat  
ske alate

Pribor za  
fenove  
za vrući  
vazduh

Pribor za  
usisivanj  
e

Pribor za  
alate za  
rad na  
otvoreno

Pribor za  
držače  
alata i  
zaštitna

Koferi i  
torbe

Ručni  
alati

Ostalo

Pribor za  
mješanje

# PRIBOR ZA PNEUMATSKE ALATE

Ekseri u žičanom kalemu



Ekseri u traci



Pojedinačno ili serijsko



## Zabijač eksera

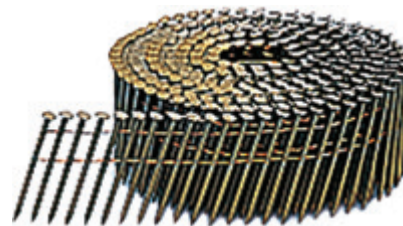

### Redenik sa glatkim ekserima



Model	Prečnik Ø (mm)	Ukupna dužina (mm)	Nagib (°)	Tip eksera	Za model	Jedinica (kom/kompl)	Cena sa PDV-om
F-30810	2,5	45	16	antikorozivni	AN621, AN901, AN902, AN610H, AN620H, AN711H, AN911H, AN960, AN961, AN635H, AN935H, AN613	10.800/1	
F-30900	2,5	65	16	antikorozivni	AN621, AN901, AN902, AN610H, AN620H, AN711H, AN911H, AN960, AN961, AN635H, AN935H, AN613	8.100/1	
F-31243	2,5	50	16	antikorozivni	AN621, AN901, AN902, AN610H, AN620H, AN711H, AN911H, AN960, AN961, AN635H, AN935H, AN613	10.800/1	
F-30823	2,8	50	16	antikorozivni	AN621, AN901, AN902, AN610H, AN620H, AN711H, AN911H, AN960, AN961, AN635H, AN935H	9.000/1	
F-30849	2,9	50	16	antikorozivni	AN621, AN901, AN902, AN610H, AN620H, AN711H, AN911H, AN960, AN961, AN635H, AN935H	9.000/1	
F-30836	3,1	65	16	antikorozivni	AN621, AN901, AN902, AN610H, AN620H, AN711H, AN911H, AN960, AN961, AN635H, AN935H	6.750/1	
F-31298	3,1	75	16	antikorozivni	AN621, AN901, AN902, AN610H, AN620H, AN711H, AN911H, AN960, AN961, AN635H, AN935H	4.050/1	
F-31304	3,1	83	16	antikorozivni	AN621, AN901, AN902, AN610H, AN620H, AN711H, AN911H, AN960, AN961, AN635H, AN935H	4.050/1	
F-31317	3,1	90	16	antikorozivni	AN621, AN901, AN902, AN610H, AN620H, AN711H, AN911H, AN960, AN961, AN635H, AN935H	4.050/1	
F-30852	3,3	65	16	antikorozivni	AN621, AN901, AN902, AN610H, AN620H, AN711H, AN911H, AN960, AN961, AN635H, AN935H	4.050/1	
F-31359	3,4	75	16	antikorozivni	AN621, AN901, AN902, AN610H, AN620H, AN711H, AN911H, AN960, AN961, AN635H, AN935H	3.600/1	
F-31362	3,8	90	16	antikorozivni	AN621, AN901, AN902, AN610H, AN620H, AN711H, AN911H, AN960, AN961, AN635H, AN935H	2.700/1	

Akumulatori i punjači

Pribor za akumulatorske alate

Akumulatori lampe i pribor

Pribor za laserske merace

Pribor za rušenje i udarno bušenje

Pribor za bušenje

Krunaste testere

Pribor za pritezanje

Pribor za sečenje i brušenje

Pribor za brušenje i poliranje

Pribor za profilisanje i poravnavanje

Pribor za višenamenski alat

Pribor za testere

Pribor za pneumatske alate

Pribor za fenove za vrući vazduh

Pribor za usisivanje

Pribor za alate za rad na otvoreno

Pribor za držače alata i zaštitna

Koferi i torbe

Ručni alati

Ostalo

Pribor za mješanje

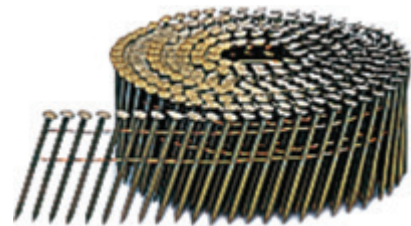

## Redenik sa navojnim ekserima



Model	Prečnik Ø (mm)	Ukupna dužina (mm)	Nagib (°)	Tip eksera	Za model	Jedinica (kom/kompl)	Cena sa PDV-om
F-30865	2,5	50	16	antikorozivni	AN610H, AN620H, AN621, AN711H, AN901, AN902, AN911H, AN930H, AN960, AN961, AN935, AN635H	10.800/1	
F-31269	2,5	65	16	antikorozivni	AN610H, AN620H, AN621, AN711H, AN901, AN902, AN911H, AN930H, AN960, AN961, AN935, AN635H	8.100/1	
F-30881	2,9	65	16	antikorozivni	AN610H, AN620H, AN621, AN711H, AN901, AN902, AN911H, AN930H, AN960, AN961, AN935, AN635H	6.750/1	
F-30971	2,9	50	16	antikorozivni	AN610H, AN620H, AN621, AN711H, AN901, AN902, AN911H, AN930H, AN960, AN961, AN935, AN635H	9.000/1	
F-31272	2,9	57	16	antikorozivni	AN610H, AN620H, AN621, AN711H, AN901, AN902, AN911H, AN930H, AN960, AN961, AN935, AN635H	6.750/1	
F-31285	2,9	71	16	antikorozivni	AN610H, AN620H, AN621, AN711H, AN901, AN902, AN911H, AN930H, AN960, AN961, AN935, AN635H	6.750/1	
F-31333	3,1	85	16	antikorozivni	AN610H, AN620H, AN621, AN711H, AN901, AN902, AN911H, AN930H, AN960, AN961, AN935, AN635H	4.050/1	
F-31320	3,2	75	16	antikorozivni	AN610H, AN620H, AN621, AN711H, AN901, AN902, AN911H, AN930H, AN960, AN961, AN935, AN635H	4.050/1	
F-31346	3,2	90	16	antikorozivni	AN610H, AN620H, AN621, AN711H, AN901, AN902, AN911H, AN930H, AN960, AN961, AN935, AN635H	4.050/1	



## Ekseri sa zakačenom glavom na papirnoj traci



Model	Prečnik Ø (mm)	Ukupna dužina (mm)	Nagib (°)	Tip eksera	Za model	Jedinica (kom/kompl)	Cena sa PDV-om
P-45783	2,9	50	34	galvanizovani	AN943	3.300/1	
F-30579	3,1	75	34	svetao	AN943	3.000/1	
F-30601	3,1	83	34	svetao	AN943	3.000/1	
F-31645	3,3	90	34	galvanizovani	AN943	3.000/1	

## Ekseri sa malom glavom 18GA



Model	Ukupna dužina (mm)	Tip eksera	Za model	Jedinica (kom/kompl)	Cena sa PDV-om
F-31867	15	galvanizovani	AF505, AF506, AF550H, DBN500, DFN350	5.000/1	
F-31870	20	galvanizovani	AF505, AF506, AF550H, DBN500, DFN350	5.000/1	
F-31883	25	galvanizovani	AF505, AF506, AF550H, DBN500, DFN350	5.000/1	
F-31896	30	galvanizovani	AF505, AF506, AF550H, DBN500, DFN350	5.000/1	
F-31902	32	galvanizovani	AF505, AF506	5.000/1	
F-31915	35	galvanizovani	AF505, AF506, AF550H, DBN500, DFN350	5.000/1	
F-31928	38	galvanizovani	AF505, AF506, AF550H, DBN500	5.000/1	
F-31931	40	galvanizovani	AF505, AF506, AF550H, DBN500	5.000/1	
F-31944	45	galvanizovani	AF505, AF506, AF550H, DBN500	5.000/1	
F-31957	50	galvanizovani	AF505, AF506, AF550H, DBN500	5.000/1	
F-32946	55	galvanizovani	AF550H	5.000/1	

## Sitni ekseri 23GA



Model	Ukupna dužina (mm)	Tip eksera	Za model	Jedinica (kom/kompl)	Cena sa PDV-om
F-31825	18	galvanizovani	AF201Z, DPT351, DPT353, AF353, PT354D	10.000/1	
F-32142	18	nerđajući	AF201Z, DPT351, DPT353, AF353, PT354D	10.000/1	

[Nastavak...](#)

 Akumulat  
ori i  
punjači

 Pribor za  
akumulat  
orske  
alate

 Akumulat  
orske  
lampe i  
pribor

 Pribor za  
laserske  
merace

 Pribor za  
rušenje i  
udarno  
bušenje

 Pribor za  
bušenje

 Krunaste  
testere

 Pribor za  
pritezani  
e

 Pribor za  
sečenje i  
brusenje

 Pribor za  
brusenje  
i  
poliranje

 Pribor za  
profilisanje  
e i  
poravnava

 Pribor za  
višenam  
enski alat

 Pribor za  
testere

 Pribor za  
pneumat  
ske alate

 Pribor za  
fenove  
za vrući  
vazduh

 Pribor za  
usisivani  
e

 Pribor za  
alate za  
rad na  
otvoreno

 Pribor za  
držače  
alata i  
zaštitna

 Koferi i  
torbe

 Ručni  
alati

Ostalo

 Pribor za  
mješanje

Model	Ukupna dužina (mm)	Tip eksera	Za model	Jedinica (kom/kompl)	Cena sa PDV-om
F-31838	25	galvanizovani	AF201Z, DPT351, DPT353, AF353, PT354D	10.000/1	
F-32155	25	nerdajuci	AF201Z, DPT351, DPT353, AF353, PT354D	10.000/1	
F-31841	30	galvanizovani	DPT351, DPT353, AF353, PT354D	10.000/1	
F-32168	30	nerdajuci	DPT351, DPT353, AF353, PT354D	10.000/1	
F-31854	35	galvanizovani	DPT351, DPT353, AF353, PT354D	10.000/1	
F-32171	35	nerdajuci	DPT351, DPT353, AF353, PT354D	10.000/1	

## Spajalice



### Spajalice 16GA

Model	Širina (mm)	Ukupna dužina (mm)	Tip eksera	Za model	Jedinica (kom/kompl)	Cena sa PDV-om
P-75091	11	25	galvanizovani	AT1150A	28.000/1	
P-75100	11	28	galvanizovani	AT1150A	14.000/1	
P-75116	11	32	galvanizovani	AT1150A	14.000/1	
P-75122	11	35	galvanizovani	AT1150A	14.000/1	
P-75138	11	40	galvanizovani	AT1150A	14.000/1	

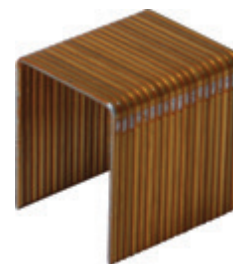

### Spajalice 16GA

Model	Širina (mm)	Ukupna dužina (mm)	Tip eksera	Za model	Jedinica (kom/kompl)	Cena sa PDV-om
F-32023	25	25	galvanizovani	AT2550A	10.000/1	
F-32036	25	32	galvanizovani	AT2550A	10.000/1	
F-32049	25	38	galvanizovani	AT2550A	10.000/1	
P-75079	25	38	galvanizovani	AT2550A	9.200/1	
F-32052	25	45	galvanizovani	AT2550A	10.000/1	





## Spjalice 18GA

Model	Širina (mm)	Ukupna dužina (mm)	Tip eksera	Za model	Jedinica (kom/kompl)	Cena sa PDV-om
F-33607	6,3	25	svetao	AT638	5.000/1	
F-33610	6,3	28	svetao	AT638	5.000/1	
F-33623	6,3	30	svetao	AT638	5.000/1	
F-33636	6,3	32	svetao	AT638	5.000/1	
F-33649	6,3	38	svetao	AT638	5.000/1	

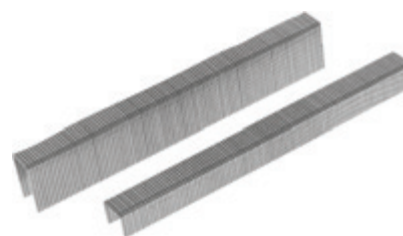

## Spjalice za akumulatorsku heftalicu

Model	Širina (mm)	Ukupna dužina (mm)	Debljina žice (mm)	Širina žice (mm)	Za model	Jedinica (kom/kompl)	Cena sa PDV-om
F-32904	10	6	0,6	1,2	DST221	5.040/1	
F-81518	10	7	0,5	0,75	DST110, ST113D, DST112	2.500/1	
F-32917	10	8	0,6	1,2	DST221	5.040/1	
F-32647	10	10	0,6	1,2	DST220, DST221, T221D	5.040/1	
F-81521	10	10	0,5	0,75	DST110, ST113D, DST112	2.500/1	
F-32650	10	13	0,6	1,2	DST220, DST221, T221D	5.040/1	
F-32663	10	16	0,6	1,2	DST220, DST221, T221D	5.040/1	
F-32676	10	19	0,6	1,2	DST220, DST221, T221D	5.040/1	
F-32689	10	22	0,6	1,2	DST220, DST221, T221D	5.040/1	

## Pribor

Model	Naziv	Za model	Cena sa PDV-om
181434-7	Mašinsko ulje, 30 ml	/	

422464-2

Štitnik

DFN350

Nastavak...

 Akumulat  
ori i  
punjači

 Pribor za  
akumulat  
orske  
alate

 Akumulat  
orske  
lampe i  
pribor

 Pribor za  
laserske  
merace

 Pribor za  
rušenje i  
udarno  
bušenje

 Pribor za  
bušenje

 Krunaste  
testere

 Pribor za  
pritezanje

 Pribor za  
sečenje i  
brusenje

 Pribor za  
brusenje i  
poliranje

 Pribor za  
profilisanje  
i  
poravnane

 Pribor za  
višenam  
enski alat

 Pribor za  
testere

 Pribor za  
pneumat  
ske alate

 Pribor za  
fenove  
za vrući  
vazduh

 Pribor za  
usisivanje

 Pribor za  
alate za  
rad na  
otvoreno

 Pribor za  
držače  
alata i  
zaštitna

 Koferi i  
torbe

 Ručni  
alati

Ostalo

 Pribor za  
mješanje

# Pribor za pneumatske alate

	Model	Naziv	Za model	Cena sa PDV-om
	422665-2	Izolacija vrha	FN001G	
	HY00000561	Izolacija vrha	AF353	

Akumulat ori i punjači
Pribor za akumulat orske alate
Akumulat orske lampe i pribor
Pribor za laserske merace
Pribor za rušenje i udarno bušenje
Pribor za bušenje
Krunaste testere
Pribor za pritezanj e
Pribor za sečenje i brusenje
Pribor za brusenje i poliranje
Pribor za profilisanj e i poravnav
Pribor za višenam enski alat
Pribor za testere
<b>Pribor za pneumat ske alate</b>
Pribor za fenove za vrući vazduh
Pribor za usisivanj e
Pribor za alate za rad na otvoreno
Pribor za držače alata i zaštitna
Koferi i torbe
Ručni alati
Ostalo
Pribor za mješanje

# PRIBOR ZA FENOVE ZA VRUĆI VAZDUH



# IZBOR PROFESIONALACA



1 Mlaznica za zaštitu stakla

2 Široka mlaznica

3 Reducirna mlaznica

4 Reflektorna mlaznica



5 Mlaznica za zavarivanje

6 Mlaznica za brzo zavarivanje

7 Mlaznica za zavarivanje sa preklapanjem

8 Reflektorna redukciona mlaznica za lemljenje



9 Pritisni valjak

10 Strugač

11 4-delni set strugača

12 Žica za zavarivanje (PP, HDPE, ABS)



A Primenljivo  
B Uključeno u cenu

PRIBOR	KATALOŠKI BR.	HG6030K	HG5030K	HG6031VK	HG6531CK	DHG180	DHG181
1 Mlaznica za zaštitu stakla	PR00000028	A	A	A	A / B	A / B	A / B
2 Široka mlaznica	PR00000029	A	A	A	A / B	A / B	A / B
3 Reducirna mlaznica	PR00000031	A	A	A	A / B	A / B	A / B
4 Reflektorna mlaznica	PR00000030	A	A	A	A / B	A / B	A / B
5 Mlaznica za zavarivanje	PR00000034	A	A	A	A / B	A	A
6 Mlaznica za brzo zavarivanje	PR00000039	A	A	A	A	A	A
7 Mlaznica za zavarivanje sa preklapanjem	PR00000032	A	A	A	A / B	A	A
8 Reflektorna redukciona mlaznica za lemljenje	PR00000033	A	A	A	A / B	A	A
9 Pritisni valjak	PR00000035	A	A	A	A / B	A	A
10 Strugač	PR00000040 PR00000042	A A	A A	A A	A A	A A	A A
11 4-delni set strugača	PR00000041	A	A	A	A	A	A
12 Žica za zavarivanje	PP	PR00000038	-	-	-	A	A
	HDPE	PR00000037	-	-	-	A	A
	ABS	PR00000036	-	-	-	A	A
Kofer		B	B	B	B	B	B

# PRIBOR ZA USISIVANJE



# Pribor za akumulatorske usisivače

Boje: ○ ● ● ● ● ● ● ● ● ● ●

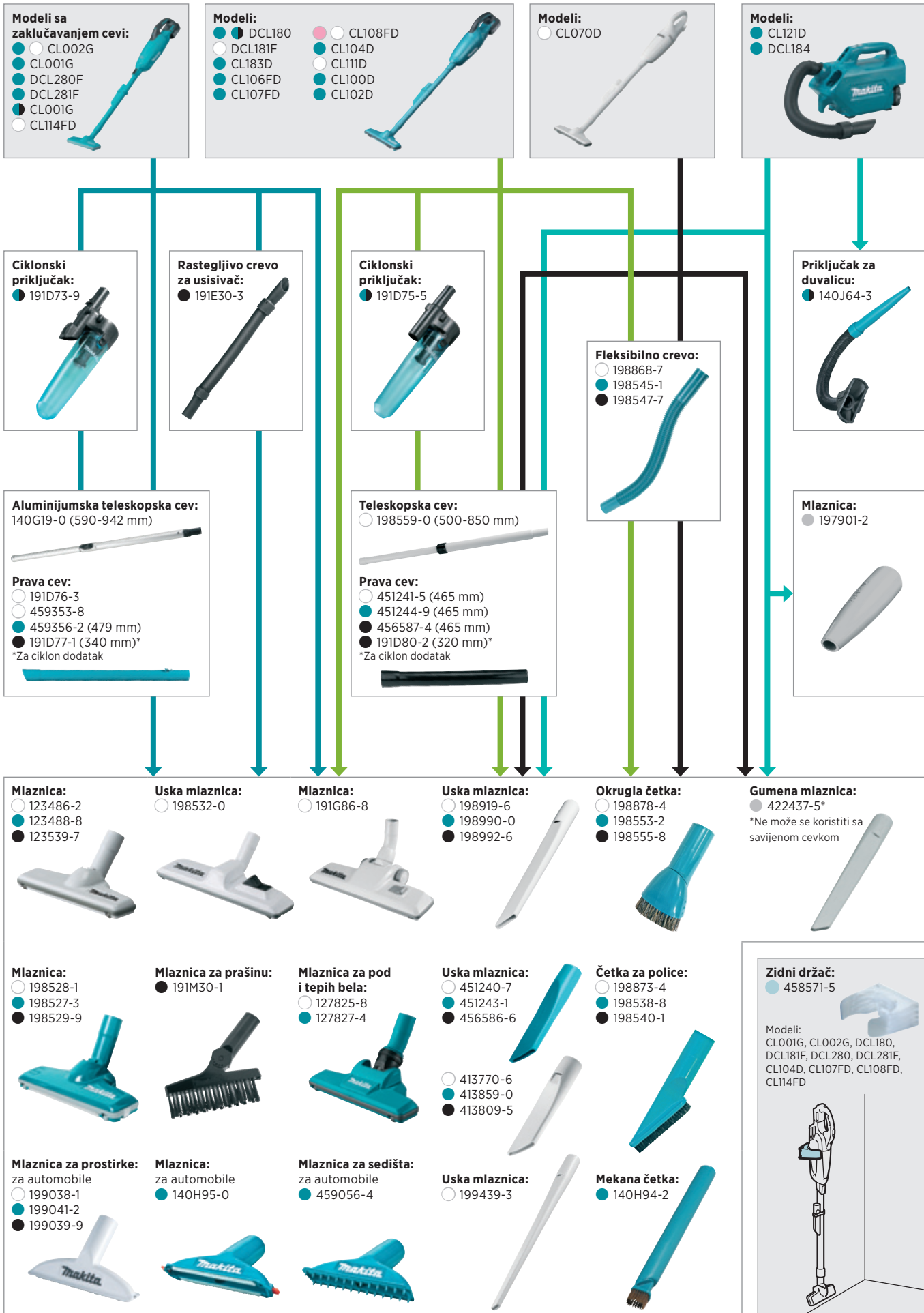

## ZA MODELE SA KUPSULNIM SISTEMOM POSUDE ZA PRAŠINU CL001G, DCL281F, DCL280F, CL183D, DCL180, CL111D, CL106FD, CL070D, CL100D, CL108FD

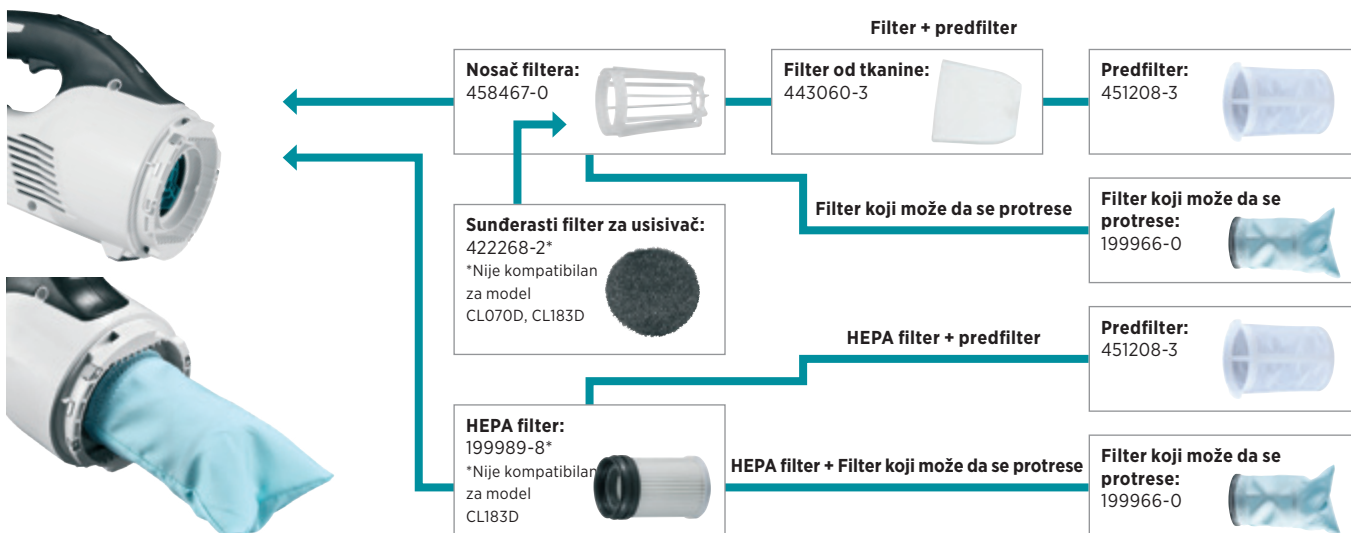

## ZA MODELE SA VREĆICOM ZA PRAŠINU

CL002G, DCL184, CL114F, CL121D, CL107FD, CL104D, CL121D

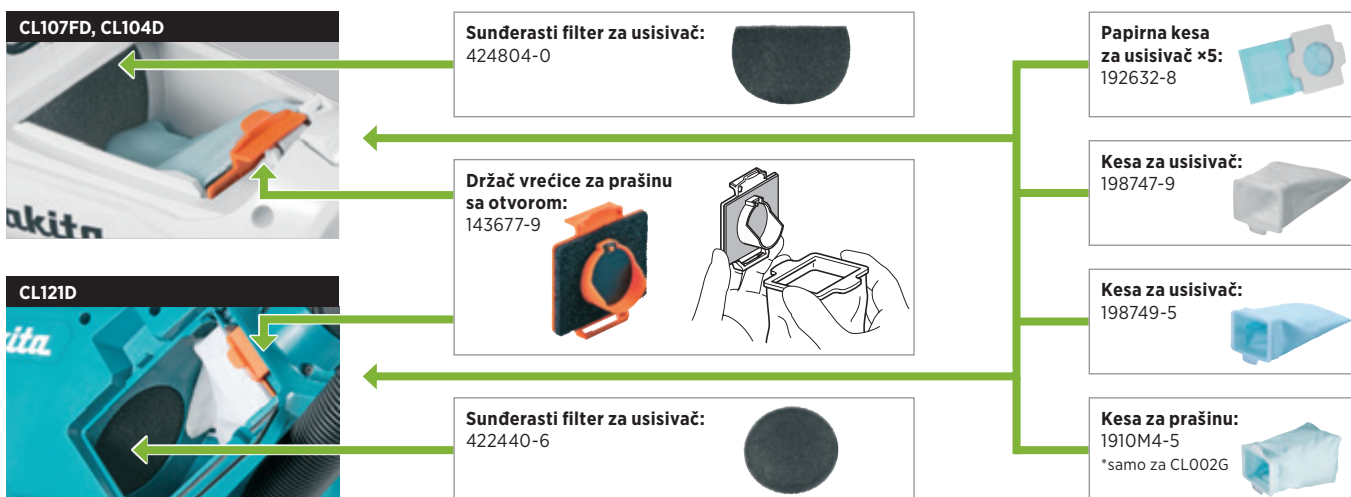

## AKUMULATORSKI RANAC USISIVAČ

DVC261, DVC265

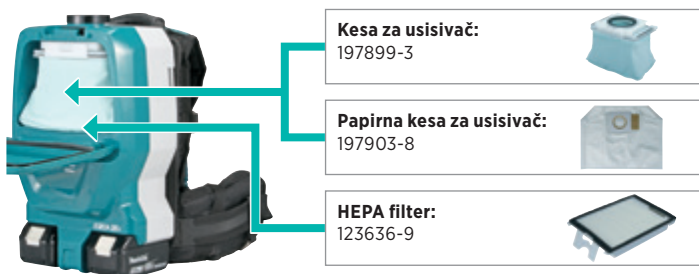

## AKUMULATORSKI RANAC USISIVAČ

VC008G, VC009G, DVC660

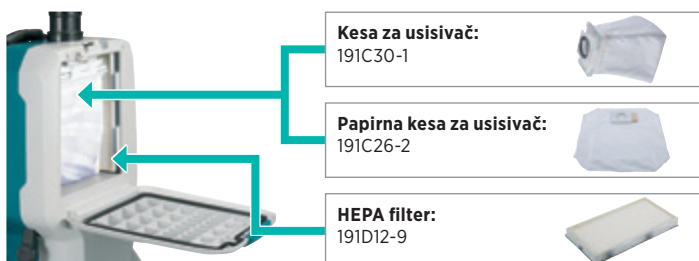

## AKUMULATORSKI USPRAVNI USISIVAČ

DVC560

**Uska mlaznica:**  
○ 451240-7  
● 451243-1  
● 456586-6



**Uska mlaznica:**  
○ 198919-6  
● 198990-0  
● 198992-6



**Uska mlaznica:**  
○ 199439-3



**Mlaznica za prostirke: za automobile**  
● 459056-4



**Mlaznica za sedišta: za automobile**  
○ 199038-1  
● 199041-2  
● 199039-9



**Mlaznica za prašinu:**  
● 191M30-1



**Četka za police:**  
○ 198873-4  
● 198538-8  
● 198540-1



**Okrugla četka:**  
○ 198878-4  
● 198553-2  
● 198555-8



**Mekana četka:**  
● 140H94-2





**Kesa za prašinu (10/1):**  
191D63-2



**HEPA filter:**  
191E39-5



**Okrugla četka:**  
191D69-0





## AKUMULATORSKI USISIVAČI - DUVALJKE

DVC750

**Rastegljivo fleksibilno crevo:**  
140G04-3  
28/2 m sa 38 priključak



**Mlaznica:**  
● 458891-7



**Okrugla četka:**  
● 191657-9



**Adapter za crevo sa 22mm na 38mm:**  
● 195548-6



**Uska mlaznica:**  
● 458919-1



**Uska mlaznica:**  
○ 410306-2



**Uska mlaznica:**  
○ 192236-6

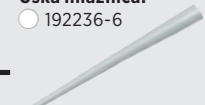

**Adapter za crevo sa 38 mm:**  
418500-0



**28 mm podne mlaznice i drugi dodaci**

**Suvo usisavanje**

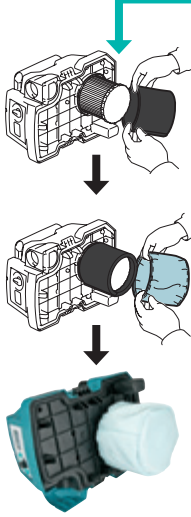

**Mokro usisavanje**



**HEPA filter:**  
162518-0\*  
\*Samo za suvo usisavanje



**Zaštita za filter:**  
422449-8



**Predfilter:**  
162635-6



**Predfilter set:**  
199827-4\*  
\*Samo za suvo usisavanje



**Zaštita za filter:**  
191M39-3



**Naramenica za nošenje:**  
199486-4





**A**



Sa crevom Ø28 mm

**Model**  
VC3211H / VC3211M  
VC2211M / VC3210L

**Priključci**



38 24 22

**B**



Sa crevom Ø28 mm

**Model**  
DVC155L  
DVC864L / DVC865L  
DVC867L

**Priključci**



38 24 22

**C**



Sa crevom Ø38 mm

**Model**  
VC001GL / VC003GL  
VC005GL  
DVC150L / DVC152L  
DVC157L / DVC860L  
DVC864L / DVC867L

**Adapter**



22-38

**D**



Sa crevom Ø28 mm

**Model**  
DVC260 / DVC261  
DVC265 / DVC660  
VC009G / VC008G

**Priključci**



38 24 22

**E**



Sa crevom Ø32 mm

**Model**  
VC2000L / VC2012L  
VC2512L / VC3011L

**Adapter 24 P-81745**  
**Adapter 38 P-70421**



24 38

**F**



Sa crevom Ø32 mm

**Model**  
VC3012L / VC4210L  
VC4210M

**Adapter 22 W107418678**  
**Adapter 24 P-70378**  
**Adapter 38 W107418688**









22 24 38

**Za model**      **Usisni sistem i br. dela**

Čekić-bušilica, čekić za rušenje



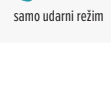



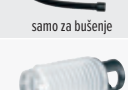

	Model	Nastavak za usisavanje prašine	Dimenzija priključka
Čekić za rušenje	HM1501, HM1502, HM1512	 191M21-2 (bez creva)	Crevo Ø28 direktno
		 191M20-4 (sa crevom)	Priključak 24 ili 38
	HM1307C, HM1317C, HM1802, HM1812	 197168-2 (bez creva)	Crevo Ø28 direktno
		 197148-8 (sa crevom)	Priključak 24 ili 38
HM001G, HM002G, HM0870C, HM0871C, HM1101C, HM1111C, HM1203C, HM1205C, HM1213C, HM1214C	 199143-4 (bez creva)	Crevo Ø28 direktno	
	 199144-2 (sa crevom)	Priključak 24 ili 38	
Čekić-bušilica	HR5212C, HR5202C, HR4001C, HR4002, HR4501C, HR4511C, HR4013C, HR4003C, HR3541C, DHR400, HR005G, HR006G	 199143-4 (bez creva)	Crevo Ø28 direktno
		 samo udarni režim 199144-2 (sa crevom)	Priključak 24 ili 38

**Za model**      **Usisni sistem i br. dela**

Bušilica-čekić

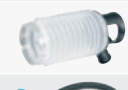
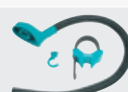

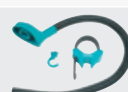
	Model	Nastavak za usisavanje prašine	Dimenzija priključka
Bušilica-čekić	HR140D, HR166D, DHR165, DHR171, DHR182, DHR202, DHR263, HR1840, HR2470, HR2800, HR2810, HR2810T, HR2811FT	 samo za bušenje 193472-7	Priključak 22
		 198362-9	Priključak 22
	*HR140D, *HR166D, *DHR165, *DHR171, *DHR182, *DHR202, *DHR241, *HR1840, DHR263, HR2470, HR2800, HR2810 *koristiti sa 194581-5	 195173-3	Priključak 22
		 195179-1	Priključak 22
	DHR280, HR001G, HR003G, HR007G, HR2300, HR2630, HR2631F, HR2641, HR2651, HR2652, HR2653, HR3001C, HR3011F	 samo udarni režim 197148-8	Priključak 22
		 196858-4	Priključak 22
	DHR243, DHR283, HR002G, HR004G, HR2320T, HR2630T, HR2631FT, HR2653T, HR3012F	 195866-2	Priključak 22
		 199142-6	Priključak 22
DHR400, HR005G, HR4013C, HR4003C	 199142-6	Priključak 22	

Za model	Usisni sistem i br. dela
----------	--------------------------

## Ručna kružna testera, testera s upuštanjem

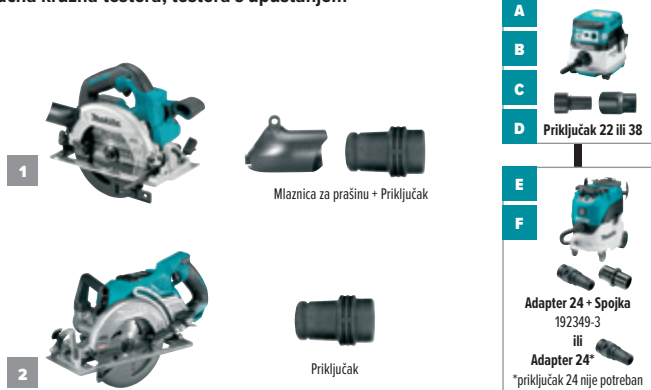

Model	Nastavak za usisavanje prašine	Dimenzija priključka
DHS630	1 194314-8	Priključak 22
DHS660, DHS661	1 199230-9	Priključak 24
DHS680	1 196961-1	Priključak 24
DHS710	1 196520-1	Priključak 24
DHS782, DHS783	1 196520-1	Priključak 24
DSS610	1 419283-5	Priključak 22
5008MG	1 194489-3	Priključak 38
5103R	1 415426-7 (bez vijka) 192419-8 (2x vijka)	Priključak 38
5104S	1 450316-7	Priključak 38
5143R	1 192490-2	Priključak 38
N5900B	1 193068-4	Priključak 38
5903R	1 192419-8	Priključak 38
HS003G/HS004G	1 196520-1	Priključak 24
HS301D, HS300D	1 195334-5	Priključak 22
HS0600	1 198263-1	Priključak 24
HS6100, HS6101	1 453289-3	Priključak 24
HS6601	1 196520-1	Priključak 24
HS7010	1 196520-1	Priključak 24
HS7100, HS7101	1 453289-3	Priključak 24
HS7611	1 196520-1	Priključak 24
HS7601, HS7611	1 196520-1	Priključak 24
DHS900, DSP600, DSP601	2 ---	Priključak 24
RS001G	2 ---	Priključak 24
RS002G, S017RKB	2 ---	Priključak 38
DSP600, DSP601, SP6000, SP0001G	2 ---	Priključak 24
HS009G, HS011G	2 ---	Priključak 24

Za model	Usisni sistem i br. dela
----------	--------------------------

## Ugaona brusilica sa dijamantskom pločom

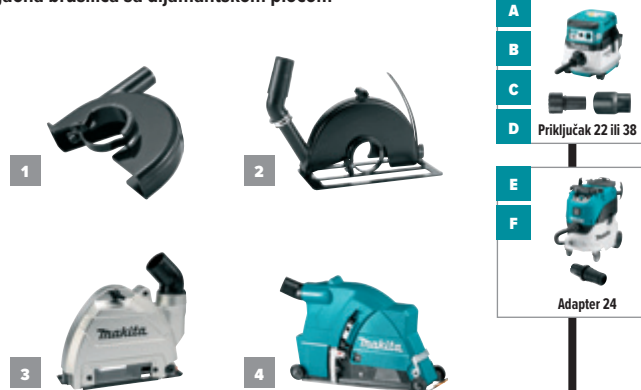

















Model	Nastavak za usisavanje prašine	Dimenzija priključka
115/125 mm modeli sa trostrukim urezima za pričvršćivanje	3 196845-3	Priključak 38
	1 198415-4	Priključak 38
115/125 mm modeli sa jednim urezom za pričvršćivanje	2 192968-5 (sa spojnicom) 192972-4 (bez spojnice)	Priključak 38
	3 196846-1	Priključak 38
125 mm X-Lock modeli	3 191605-4	Priključak 38
125 mm modeli sa zaštitama koje se montiraju bez alata	3 191606-2	Priključak 38
230 mm modeli sa tri preklopna žleba bez kočnice motora	4 198440-5	Priključak 38
230 mm modeli sa jednostrukim / dvostrukim urezima za pričvršćivanje	2 194044-1	Priključak 38

## Ugaona brusilica sa dijamantskom pločom















Model	Nastavak za usisavanje prašine	Dimenzija priključka
125 mm modeli sa zaštitama koje se montiraju bez alata	191F81-2	Priključak 38
115/125 mm modeli sa trostrukim urezima za pričvršćivanje	195239-9	Priključak 38
230 mm modeli sa trostrukim urezima za pričvršćivanje	195385-8	Priključak 38



Za model		Usisni sistem i br. dela	
<b>Tračna brusilica</b> 9032 Aku. tračna brusilica DBS180	<b>Spojka</b> 122652-8	<b>A</b>  Prikjučak 22	<b>A</b>  Prikjučak 22
<b>Tračna brusilica</b> 9031		<b>B</b>  Prikjučak 22	<b>B</b>  Prikjučak 22
<b>Vibraciona brusilica</b> 9046, B03710, B03711, B04900V, B04901, B04555, B04565, B04557 Aku. ekscentrična brusilica DBO380, DBO381		<b>C</b>  Adapter 22-38	<b>C</b>  Adapter 22-38
<b>Ekscentrična brusilica</b> B05030, B05031, B05041, B06030, B06040 Aku. ekscentrična brusilica DB0180		<b>D</b>  Prikjučak 22	<b>D</b>  Priključak 22
<b>Ekscentrična brusilica</b> B06050	<b>Priključak 24</b> 195546-0	<b>E</b>  Adapter 24 + Spojka 192349-3 ili Adapter 24* *priključak 24 nije potreban	<b>E</b>  Adapter 24 + Spojka 192349-3 ili Adapter 24* *priključak 24 nije potreban
<b>Tračna brusilica</b> 9404, 9903, 9910, 9911, 9920		<b>F</b>  Adapter 38 + Spojka 195548-6 ili Adapter 24* *priključak 24 nije potreban	<b>F</b>  Adapter 38 + Spojka 195548-6 ili Adapter 24* *priključak 24 nije potreban
<b>Tračna brusilica</b> 9403, 9921			
<b>Aku. višenamenski alat</b> DTM50 DTM51 DTM52 <b>Višenamenski alat</b> TM3000C TM3010C	<b>Mlaznica za prašinu</b> 195965-0 196765-1 191R02-6 196022-7 199624-8		















Za model		Usisni sistem i br. dela	
<b>Glodilica za aluminijumske materijale</b> CA5000		<b>A</b>  Priključak 24 195546-0	<b>A</b>  Priključak 22
<b>Aku. ubodna testera</b> DJV180, DJV181, DJV182 <b>Ubodna testera</b> 4350CT, 4350FCT, 4351CT, 4351FCT JV103D**, JV102D** DJV184		<b>Mlaznica za prašinu</b> 126331-0 457801-1 + Priključak 24 195546-0	<b>B</b>  Priključak 22
<b>Uvodna testera</b> JV100D, JV143D, 4326, 4327, 4329, JV0600		**Koristi se sa štitnikom za prašinu 458191-5	<b>C</b>  Adapter 22-38
<b>Aku. ubodna testera</b> DJV180, DJV181, DJV182 <b>Ubodna testera</b> 4350CT, 4350FCT, 4351CT, 4351FCT		<b>Mlaznica za prašinu</b> 417853-4	<b>D</b>  Priključak 22
<b>Ručna kružna testera</b> DHS630 DSS611, DSS610 HS300D, HS301D		<b>Mlaznica za prašinu</b> 194314-8 419283-5 195334-5	<b>E</b>  Adapter 24 + Spojka 192349-3 ili Adapter 24* *priključak 24 nije potreban
<b>Aku. brusilica za gips</b> DSL800, DSL801		+ Priključak 24 195546-0	<b>F</b>  Adapter 38 + Spojka 195548-6 ili Adapter 24* *priključak 24 nije potreban















Za model







Usisni sistem i br. dela

<p>Ugaoni rezač 4112HS</p> 	<p>Kolenasta spojka 192613-2</p> 	<p><b>A</b> </p> <p><b>B</b> </p> <p><b>C</b> </p> <p><b>D</b> </p> <p><b>E</b> </p> <p><b>F</b> </p>
<p>Dijamantski rezač 4100KB Aku. dijamantski rezač DCC500</p> 		
<p>Dijamantski rezač sa usisivanjem 4157KB</p> 		
<p>Rezač kanala SG1251, SG1250</p> 		
<p>Brusilica za beton PC5000C, PC5001C</p> 		
<p>Brusilica sa četkom 9741</p> 	<p>Spojka 410899-9</p> 	

Za model

Usisni sistem i br. dela

<p>Akumulatorska testera za koso sečenje DLS713, DLS714, DLS600</p> 	<p><b>A</b> </p> <p><b>B</b> </p> <p><b>C</b> </p> <p><b>D</b> </p> <p><b>E</b> </p> <p><b>F</b> </p>	
<p>Nagibna stona testera (flip sistem) LF1000</p> 		
<p>Nagibna stona testera LH1040, LH1201FL</p> 		
<p>Potezno-nagibna testera LS1019, LS1019L, LS1219L Aku. testera za koso sečenje DLS111, DLS211, LS002G LS003G, LS004G</p> 		<p>+ Priključak 24 195546-0</p> 

Za model	Usisni sistem i br. dela
<b>Stona kružna testera</b> 2704N 	<b>Spojka</b> 419093-0 
<b>Stona kružna testera</b> 2712 	
<b>Stona kružna testera</b> MLT100N 	<b>Spojka</b> JM2700090 
<b>Tračna testera</b> LB1200F 	<b>Spojka</b> 419093-0 

**A**



Prikjučak 38

**B**



Prikjučak 38

**C**



Direktno

**D**



Direktno

**E**











Adapter 38

**F**



Adapter 38

Za model	Usisni sistem i br. dela
<b>Akumulatorska rendisaljka</b> DKP181, KP001G <b>Rendisaljka</b> KP0810, KP0810C 	<b>Kolenasto crevo</b> ***191C20-4  ***Opcionarno
<b>Akumulatorska rendisaljka</b> DKP180 <b>Rendisaljka</b> KP0800 	<b>Prikjučak za crevo</b> 451329-1 
<b>Rendisaljka</b> 1911B 	<b>Prikjučak za crevo</b> 192082-7 
<b>Rendisaljka</b> N1923B, KP0800, 1806B, KP312S 	

**A**



Prikjučak 38

**B**



Prikjučak 38

**C**



Direktno

**D**



Prikjučak 38

**E**



Adapter 38

**F**



Adapter 38

Model	ID broj	Model	ID broj
N1923B	181572-5	N1923B	JPA122275
KP0800, DKP180	451329-1	DKP180, KP0810, KP0810C, KP0800	416368-8
1806B	122397-8	1806B, KP312S	181575-9
KP312S	193733-5		





## Za model







## Usisni sistem i br. dela

<p>Aku. glodilica za žljebove DPJ180 Glodilica za žljebove PJ7000, 3901</p> 	
<p>Rotacioni sekač 3706</p> 	<p>Mlaznica za prašinu 193449-2</p> 
<p>Akumulatorska glodilica DCO180, DCO181</p> 	
<p>Akumulatorska testera za gipsane ploče DSD180, SD100D</p> 	
<p>Glodilica RP0910, RP110C RP111C</p> 	



## Za model

## Usisni sistem i br. dela

<p>Glodilica RP1801F, RP1800, RP1800F, RP1803F RP2301FC, RP2300FC, RP2303F</p> 	<p>Mlaznica za prašinu 194934-8</p> 
<p>Glodilica RP0900, ***RT0700C ***RT0702C</p> <p>Akumulatorska glodilica ***DRT50</p>  <p>***Koristite sa bazom za uranjanje</p>	<p>Mlaznica za prašinu 194733-8</p> 
<p>Glodilica RT0700C</p> <p>Akumulatorska glodilica DRT50</p> 	<p>Mlaznica za prašinu 195559-1</p> 



MAKITA preporučuje  
upotrebu Ø38 mm  
creva prilikom rada  
sa glodalom.

## PRIKLJUČCI I ADAPTERI

**Crevo Ø28 mm**  
sa priključci 22/38

**Zadnja manžetna**

**Priključak 38**  
Unutrašnji Ø 38 mm  
Spoljašnji Ø 44,2 mm

**Priključak 22**  
Unutrašnji Ø 22,4 mm  
Spoljašnji Ø 25 mm

**Crevo Ø38 mm**  
sa priključkom 38

**Zadnja manžetna**

**Priključak 38**  
Unutrašnji Ø 38 mm  
Spoljašnji Ø 44,2 mm

**Priključci za povezivanje 22, 38 i 24**

**Crevo Ø28 mm**  
sa priključkom 22

**Crevo Ø28 mm**  
sa priključkom 38

**Crevo Ø38 mm**  
sa priključkom 38

**Priključak 24**  
195546-0

**Priključci za povezivanje**

Crevo Ø28 mm/Priključak 38

Crevo Ø38 mm/Priključak 38

Crevo Ø28 mm/Zadnja manžetna

Crevo Ø38 mm/Zadnja manžetna

**Adapter 22-38 konekcija**

Crevo Ø28 mm/Priključak 38

**Adapter 22-38**  
Unutrašnji Ø 38 mm  
Spoljašnji Ø 44,2 mm

## KOMPLET SISTEMA ZA ODVOĐENJE PRAŠINE

**Model**  
DVC150L / DVC152L  
DVC155L / DVC157L  
DVC860L / DVC862L  
DVC864L  
DVC865L  
DVC867L  
VC001GL  
VC003GL  
VC005GL

**Model**  
DVC260 / DVC261  
DVC660 / DVC265  
VC008G / VC009G

**Model**  
VC3211H  
VC3211M  
VC2211M  
VC3210L

**Crevo Ø28 mm**

\*143787-2 (1,0 m) direktna konekcija  
A-34235 (1,5 m) priključak 22, 38  
195433-3 (3,5 m) priključak 22, 24, 38

\*samo za modele DVC260, DVC261, DVC660, DVC265, VC008G, VC009G

**Crevo Ø38 mm**

195434-1 (2,5 m) Priključak 38

**Priključak**

**22** 195547-8

**38** 195545-2

**Priključak**

**24** 195546-0

**Adapter**

**22-38** 195548-6

**Priključak**

**24** 195546-0

**Model**  
DVC750L

**Model**  
VC2000L  
VC2012L  
VC2512L  
VC3011L

**Model**  
VC3012L  
VC4210L  
VC4210M

**Crevo Ø32 mm**

P-81739 (3,5 m)

**Crevo Ø32 mm**

P-84084 (4 m)

**Adapter**

**Adapter**

**22** W107418678  
**24** P-70378  
**38** W107418688

**Priključci**

# Sistemska tabela

Boje:       Mokro usisavanje: Mokro/suvo usisavanje:

Povezuje 28:  sa okretnim priključkom  Povezuje 38:  Povezuje 32:

\*za modele DVC260, DVC261, DVC660, DVC265, VC008G, VC009G

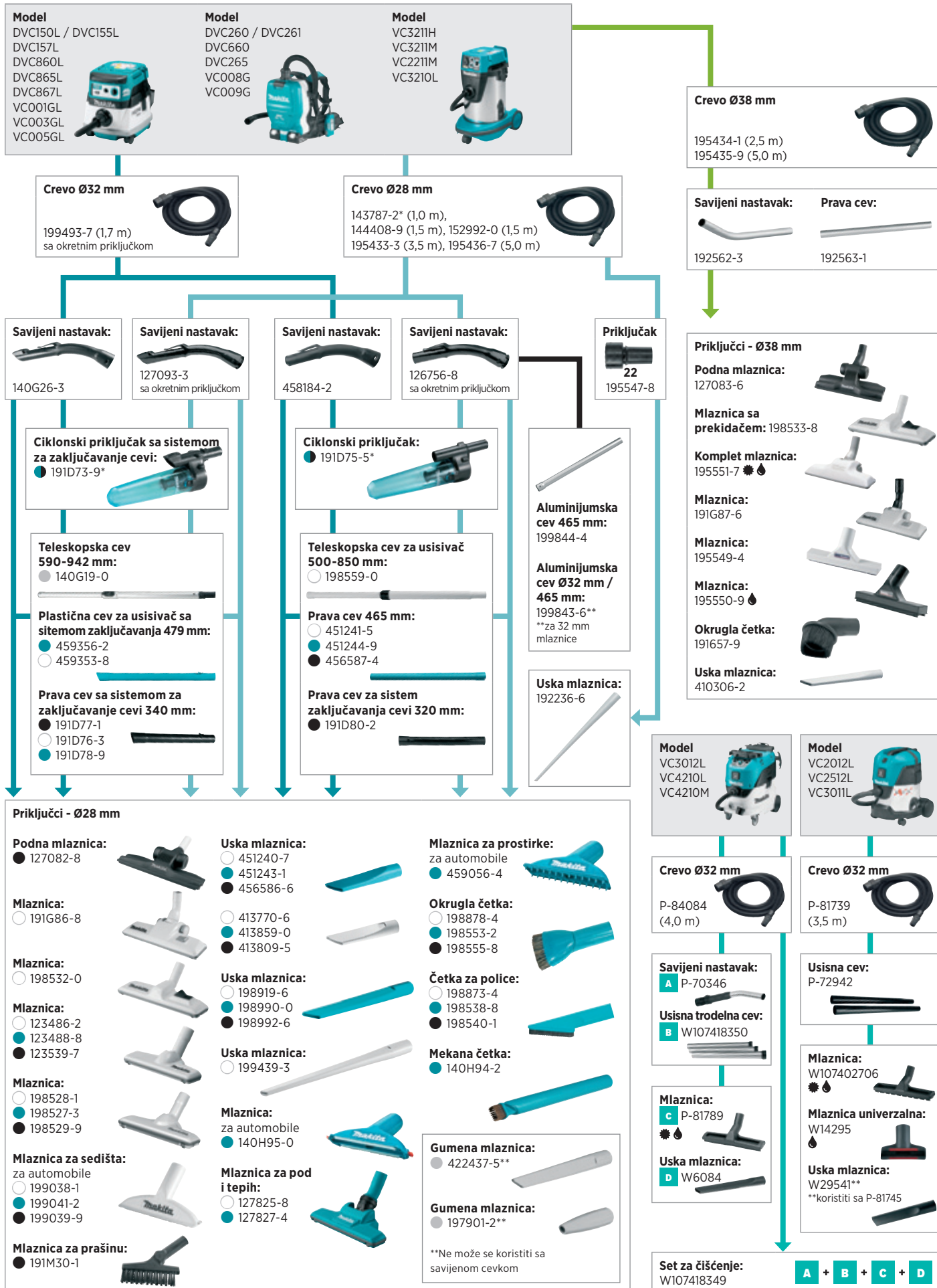



## A Fleksibilna creva

Model	Opis	Dužina	Prečnik	Priključci	Model usisivača								
					VC2000L	VC2012L	VC2512L	VC3011L	VC3012L	VC4210L	VC4210M		
1	P-70362	●	☒	Plastično crevo sa sistemom zaključavanja i rotacionim priklonom za usisivač	3,0 m	36					✓	✓	✓
2	P-70487	●	☒	Plastično crevo sa rotacionim priklonom za usisivač	3,5 m	27	24				✓	✓	✓
3	P-84084	●	☒	Plastično crevo sa sistemom zaključavanja i rotacionim priklonom za usisivač	4,0 m	32	32B			P	P	P	
4	P-81739	●		Plastično crevo sa sistemom zaključavanja i priloženom ukrivljenom cevi	3,5 m	32	32B	P	P	P	P		

☒: antistatična P: priloženo ✓: opciono

## B Savijene cevi i setovi

Model	Opis				
		1	2	3	4
		P-70362	P-70487	P-84084	P-81739
5	P-70346	●			
6	W107413340	●			✓
7	W107418349	●			✓

## C Ravne cevi

Model	Opis		
		5	6
		P-70346	W107413340
8	P-70437	●	
9	W107418350	●	
10	P-72942	●	

## D Mlaznice

Model	Opis			
		8	9	10
		P-70437	W107418350	P-72942
P-81789	Podna mlaznica za suvo i mokro čišćenje, 300 mm	✓	✓	
W107402706	Podna mlaznica za suvo i mokro čišćenje, 260 mm			✓
W14295	Univerzalna mlaznica za suvo i mokro čišćenje, 120 mm			✓
W29541	Uska mlaznica, 200 mm*			✓
W6084	Uska mlaznica, 300 mm	✓	✓	

\*Upotrebiti sa P-81745 adapterom sa regulacijom



- Akumulat
- Pribor za akumulat
- Akumulat
- Pribor za laserske
- Pribor za rušenje i udarno bušenje
- Pribor za bušenje
- Krunaste testere
- Pribor za pritezanje
- Pribor za sečenje i bušenje
- Pribor za bušenje i poliranje
- Pribor za profilisanje i poravnavanje
- Pribor za višenamenski alat
- Pribor za testere
- Pribor za pneumatske alate
- Pribor za feneve za vrući vazduh
- Pribor za usisivanje
- Pribor za alate za rad na otvoreno
- Pribor za držače alata i zaštitna
- Koferi i torbe
- Ručni alati
- Ostalo
- Pribor za mješanje

## A Fleksibilna creva

Model	Opis	Dužina	Prečnik	Priklučci	Model usisivača										
					VC2211M	VC3210L	VC3211H	VC3211M	DVC150L	DVC152L	DVC155L	DVC860L	DVC865L	DVC867L	
1 144408-9	● ⚡ Plastična	1,5 m	28		✓	✓	✓	✓	✓	✓	✓	✓	✓	✓	✓
2 152992-0	● ⚡ Plastična	1,5 m	28	38	✓	✓	✓	✓	✓	✓	✓	✓	✓	✓	✓
3 A-34235	● ⚡ Plastična	1,5 m	28	22/38	✓	✓	✓	✓	✓	✓	✓	✓	✓	✓	✓
4 195433-3	● ⚡ Plastična	3,5 m	28	22/24/38	✓	P	✓	✓	✓	✓	✓	✓	✓	✓	✓
5 191G76-1	● ⚡ Plastična ojačana sa najlonskom mrežicom	5,0 m	28	22/24/38	✓	✓	✓	✓	✓	✓	✓	✓	✓	✓	✓
6 199493-7	● ⚡ Plastična ojačana sa sistemom zaključavanja	1,7 m	32	32A	✓	✓	✓	✓	✓	✓	P	✓	P	✓	✓
7 195434-1	● ⚡ Plastična	2,5 m	38	38	P	P	P	P	P	P	✓	P	✓	P	✓

⚡ antistatična P: priloženo ✓: opciono

## B Savijene cevi

Model	Opis	1	2	3	4	5	6	7
		144408-9	152992-0	A-34235	195433-3	191G76-1	199493-7	195434-1
8 126756-8	● Plastična sa rotacionim priklopom	✓	✓	✓	✓	✓		
9 127093-3	● Plastična sa rotacionim priklopom i sistemom zaključavanja	✓	✓	✓	✓	✓		
10 458184-2	● Plastična						✓	
11 140G26-3	● Plastična sa sistemom zaključavanja						✓	
12 192562-3	● Aluminijumska		✓	✓	✓	✓		✓

## C Ravne cevi

Model	Opis	8	9	10	11	12
		126756-8	127093-3	458184-2	140G26-3	192562-3
13 191D80-2	● 320 mm plastična	✓		✓		
14 451241-5	○	✓		✓		
15 451244-9	● 465 mm plastična	✓		✓		
16 456587-4	●	✓		✓		
17 198559-0	○ 500-850 mm plastična	✓		✓		
18 199844-4	● 465 mm aluminijumska	✓		✓		
19 199843-6	● 465 mm aluminijumska	✓		✓		
20 191D76-3	○		✓			✓
21 191D77-1	● 340 mm plastična sa sistemom zaključavanja		✓			✓
22 191D78-9	●		✓			✓
23 459356-2	● 480 mm plastična sa sistemom zaključavanja		✓			✓
24 140G19-0	● 590-942 mm alu. sa sistemom zaključavanja		✓			✓
25 192563-1	● 565 mm aluminijumska					✓

## D Mlaznice

Tip mlaznice	13	14	15	16	17	18	19	20	21	22	23	24	25
	191D80-2	451241-5	451244-9	456587-4	198559-0	199844-4	199843-6	191D76-3	191D77-1	191D78-9	459356-2	140G19-0	192563-1
28 mlaznice	✓	✓	✓	✓	✓			✓	✓	✓	✓	✓	
32 mlaznice						✓	✓						
38 mlaznice													✓



## A Fleksibilna creva

Model	Opis	Dužina	Prečnik	Priključci	Model usisivača			
					DVC260	DVC261	DVC265	DVC660
1 143787-2	● (antistatična) Plastična	1,0 m	28		P	P	✓	✓
2 144408-9	● Plastična	1,5 m	28		✓	✓	✓	✓
3 152992-0	● Plastična	1,5 m	28	38	✓	✓	✓	✓
4 A-34235	● Plastična	1,5 m	28	22/38	✓	✓	P	✓
5 140F62-3	● Plastična ojačana sa sistemom zaključavanja	1,0 m	32	32A	✓	✓	✓	P
6 199493-7	● Plastična ojačana sa sistemom zaključavanja	1,7 m	32	32A	✓	✓	✓	✓

●: antistatična P: priloženo ✓: opciono

## B Savijene cevi

Model	Opis	1	2	3	4	5	6
		143787-2	144408-9	152992-0	A-34235	140F62-3	199493-7
7 126756-8	● Plastična sa rotacionim priklonom	✓	✓	✓	✓		
8 127093-3	● Plastična sa rotacionim priklonom i sistemom zaključavanja	✓	✓	✓	✓		
9 458184-2	● Plastična					✓	✓
10 140G26-3	● Plastična sa sistemom zaključavanja					✓	✓
11 192562-3	● Aluminijumska			✓	✓		

## C Ciklonski priključci i ravne cevi

Model	Opis	7	8	9	10	11	11
		126756-8	127093-3	458184-2	140G26-3	192562-3	192562-3
12 191D75-5	● Ciklonski priključak		✓		✓		
13 191D80-2	● 320 mm plastična za ciklonski priključak		✓		✓		
14 451241-5	○		✓		✓		
15 451244-9	● 465 mm plastična		✓		✓		
16 456587-4	●		✓		✓		
17 198559-0	○ 500-850 mm plastična		✓		✓		
18 199844-4	● 465 mm aluminijumska	Uporabi kot komplet	✓		✓		
19 199843-6	● 465 mm aluminijumska		✓		✓		
20 191D73-9	● Ciklonski priključak sa sistemom zaključavanja			✓		✓	
21 191D76-3	○			✓		✓	
22 191D77-1	● 340 mm plastična sa sistemom zaključavanja za ciklonski priključak			✓		✓	
23 191D78-9	●			✓		✓	
24 459356-2	● 480 mm plastična sa sistemom zaključavanja			✓		✓	
25 140G19-0	● 590-942 mm alu. sa sistemom zaključavanja			✓		✓	
26 192563-1	● 565 mm aluminijumska						✓





















## D Mlaznice

Tip mlaznice	13	14	15	16	17	18	19	21	22	23	24	25	26
	191D80-2	451241-5	451244-9	456587-4	198559-0	199844-4	199843-6	191D76-3	191D77-1	191D78-9	459356-2	140G19-0	192563-1
28 mlaznice	✓	✓	✓	✓	✓			✓	✓	✓	✓	✓	
32 mlaznice						✓	✓						
38 mlaznice													✓



- Akumulat orni punjači
- Pribor za akumulat orske alat
- Akumulat orske lampe i pribor
- Pribor za laserske merace
- Pribor za rušenje i udarno bušenje
- Pribor za bušenje
- Krunaste testere
- Pribor za pritezanje
- Pribor za sečenje i bušenje
- Pribor za bušenje i poliranje
- Pribor za profilisanje i poravnanje
- Pribor za višenamenski alat
- Pribor za testere
- Pribor za pneumatske alat
- Pribor za fenove za vrući vazduh
- Pribor za usisivanje
- Pribor za alat za rad na otvoreno
- Pribor za držače alata i zaštitna
- Koferi i torbe
- Ručni alat
- Ostalo
- Pribor za mješanje

## 28 Mlaznice

Model	Naziv	
127082-8	Podna mlaznica, 285 mm	
191G86-8	Podna mlaznica za tepihe sa dugmetom, 320 mm	
198532-0	Podna mlaznica za tepihe sa dugmetom, 320 mm	
123486-2	○	
123488-8	● Podna mlaznica, 220 mm	
123539-7	●	
198528-1	○	
198527-3	● Mlaznica za tepihe, 220 mm	
198529-9	●	
199038-1	○	
199041-2	● Mlaznica za čišćenje sedišta, 180 mm	
199039-9	●	
191M30-1	Mlaznica za prašinu, 165 mm	
451240-7	○	
451243-1	● Uska mlaznica, 160 mm	
456586-6	●	
413770-6	○	
413859-0	● Uska mlaznica, 160 mm	
413809-5	●	
198919-6	○	
198990-0	● Mlaznica za čišćenje uglova, 330 mm	
198992-6	●	
199439-3	Uska mlaznica, 415 mm	
140H95-0	Mlaznica za čišćenje sedišta, 120 mm	
127825-8	○	
127827-4	● Podna mlaznica, 220 mm	
459056-4	Mlaznica za tepihe, 120 mm	
198878-4	○	
198553-2	● Okrugla četka, 120×60 mm	
198555-8	●	
198873-4	○	
198538-8	● Mlaznica sa četkom, 180 mm	
198540-1	●	
140H94-2	Mekana četka, 360 mm	
422437-5	Gumirana mlaznica, 330 mm	
197901-2	Uska gumirana mlaznica, 155 mm	
122234-6	Mlaznica, 225 mm	

## 32 mlaznice

Model	Naziv	
P-81789	Podna mlaznica za suvo i mokro čišćenje, 300 mm	
W107402706	Podna mlaznica za suvo i mokro čišćenje, 260 mm	
W14295	Univerzalna mlaznica za suvo i mokro čišćenje, 120 mm	
W29541	Uska mlaznica, 200 mm*	
W6084	Uska mlaznica, 300 mm	

\*Upotrebiti sa P-81745 adapterom sa regulacijom

## 38 mlaznice

Model	Naziv	
127083-6	Podna mlaznica, 285 mm	
198533-8	Podna mlaznica sa dugmetom za suvo čišćenje, 320 mm	
195551-7	Mlaznica za suvo i mokro čišćenje, 320 mm	
191G87-6	Podna mlaznica za tepihe sa dugmetom, 320 mm	
195549-4	Mlaznica za suvo čišćenje, 210 mm	
195550-9	Mlaznica za mokro čišćenje, 210 mm	
191657-9	Okrugla četka, 130×60 mm	
410306-2	Uska mlaznica, 330 mm	
458891-7	Mlaznica, 130 mm	

## Filteri

	Suvo DVC156L DVC157L DVC861L DVC866L DVC867L	Suvo/mokro DVC155L DVC865L DVC860L	Suvo/mokro VC3211H VC3211M VC2211M	Suvo/mokro VC3210L	Suvo/mokro VC001GL VC003GL	Suvo/mokro VC002GL VC004GL VC005GL
Upotrebiti kao set	<b>Filter prašine</b>		 VC3211H: 196251-2* VC3211M, VC2211M: 196252-0*			
	<b>Zaštita za filter</b>					
	<b>Predfilter</b>					
<b>Tekstilni filter</b> Suvo i mokro čišćenje						
<b>Filter za vodu</b> Samo mokro čišćenje Kod čišćenja velike količine vode, preporučujemo upotrebu vodnog filtera.						
<b>Papirna kesha za usisivač 15L</b> (za suvo čišćenje)						
<b>Papirna kesha za usisivač 25L</b> (za suvo čišćenje)						
<b>Plastična kesha za usisivač</b>						



### Za suvo usisavanje

- Filter prašine
- Penasti filter ("prigušivač")
- Predfilter
- Papirna ili plastična vreća za prašinu

### Za suvo i mokro usisavanje

Tekstilni ili filter za vodu (mokro čišćenje)

### Kompatibilan sa plastičnim kesama













- Omogućava brzo i jednostavno pražnjenje
- Niži troškovi naspram papirnih vreća



- Akumulat
- Pribor za akumulat
- Akumulat
- Pribor za laserske
- Pribor za rušenje i udarno bušenje
- Pribor za bušenje
- Krunaste testere
- Pribor za pritezanje
- Pribor za sečenje i brušenje
- Pribor za brušenje i poliranje
- Pribor za profilisanje i poravnava
- Pribor za višenamenski alat
- Pribor za testere
- Pribor za pneumatske alate
- Pribor za fenove za vrući vazduh
- Pribor za usisivanje
- Pribor za alate za rad na otvoreno
- Pribor za držače alata i zaštitna
- Koferi i torbe
- Ručni alati
- Ostalo
- Pribor za mješanje

## Filteri

## Filteri

	Model	Naziv	Za model	Cena sa PDV-om
	127725-2	Filter	DVC260	
	140248-3	Tekstilna filter korpa	DVC150L, DVC155L, DVC865L, DVC860L	
	144625-1	Filter od filca	VC001G, VC003G, VC004G	
	162518-0	Vazdušni filter DVC750	DVC750	
	162635-6	Predfilter	DVC750	
	191E39-5	Filter	DVC560	
	191G88-4	Tekstilni filter	DVC866L, DVC156L	
	191M39-3	Filter za mokro usisavanje	DVC750	
	191V67-2	Filter za vodu	VC001G, VC003G	
	191V68-0	Zaštita za filter	VC004G	
	191V69-8	Predfilter	VC004G	
	191V70-3	Filter	VC004G	

[Nastavak...](#)

# Pribor za usisivanje

Model	Naziv	Za model	Cena sa PDV-om	
191V71-1	Filter od filca	VC005G		
195441-4	Filter	VC2510L, VC3210L		
195552-5	Zaštita za filter	DVC150L, DVC155L, DVC865L, DVC860L, DVC151L, DVC156L, DVC157L, DVC861L, DVC866L, DVC867L, VC3210L, VC2510L, VC1310L		
195553-3	Predfilter	DVC150L, DVC155L, DVC865L, DVC860L, DVC151L, DVC156L, DVC157L, DVC861L, DVC866L, DVC867L, VC1310L		
195555-9	Filter za vodu	DVC150L, DVC155L, DVC865L, DVC860L, VC1310L		
195611-5	Filter za vodu	VC3210L		
195612-3	Predfilter	VC3210L		
196251-2	Filter tip-H	VC3211H		
196252-0	Filter tip-M	VC3211M, VC2211M, VC2201M		
196253-8	Predfilter	VC3211H, VC3211M, VC2211M, VC2201M		
196254-6	Zaštita za filter	VC3211H, VC3211M, VC2211M, VC2201M		
197166-6	Filter	DVC150L, DVC155L, DVC865L, DVC860L, DVC151L, DVC156L, DVC157L, DVC861L, DVC866L, DVC867L		
199827-4	Predfilter	DVC750		

Nastavak...

- Akumulatori i punjači
- Pribor za akumulatorske alate
- Akumulatorske lampe i pribor
- Pribor za laserske merace
- Pribor za rušenje i udarno bušenje
- Pribor za bušenje
- Krunaste testere
- Pribor za pritezanje
- Pribor za sečenje i brusenje
- Pribor za brusenje i poliranje
- Pribor za profilisanje i poravnavanje
- Pribor za višenamenski alat
- Pribor za testere
- Pribor za pneumatske alate
- Pribor za fenove za vrući vazduh
- Pribor za usisivanje
- Pribor za alate za rad na otvoreno
- Pribor za držače alata i zaštitna
- Koferi i torbe
- Ručni alati
- Ostalo
- Pribor za mješanje



# Pribor za usisivanje

	Model	Naziv	Za model	Cena sa PDV-om
	199966-0	Filter koji može da se protrese	DCL281F, DCL280F, DCL181F, DCL180F, DCL180, CL183D, CL111D, CL106FD, CL070D	
	199989-8	Filter	DCL281F, DCL280F, DCL181F, DCL180F, DCL180, CL183D, CL111D, CL106FD	
	422268-2	Sunderasti filter za usisivač	DCL281F, DCL280F, DCL180, CL111D, CL106FD, CL100D, CL108FD	
	422449-8	Zaštita za filter	DVC750	
	443060-3	Filter	DCL281F, DCL280F, DCL181F, DCL180F, DCL180, CL183D, CL111D, CL106FD, CL070D	
	451208-3	Predfilter	DCL281F, DCL280F, DCL181F, DCL180F, DCL180, CL183D, CL111D, CL106FD, CL070D, CL001G	
	83035BHB	Filter sa poliuretanskom penom za vlagu	440, 448, 445X	
	83035H0B	Filter sa poliuretanskom penom za vlagu	449	
	83140H0G	Filter	449	
	P-70219	Filter	VC3012M/L, VC2512L, VC3011L, VC2000L	
	P-70225	Filter	447L, 447M	
	W107418351	Filter PTFE	VC4210L/M	
	W107418352	Filter motorni	VC4210L/M	

[Nastavak...](#)



# Pribor za usisivanje

Model	Naziv	Za model	Cena sa PDV-om	
W29747	Filter	442, 443		
W302000525	Filter od tkanine	447L		
W302000606	Filter od tkanine	446L		

Akumulat  
ori i  
punjači

Pribor za  
akumulat  
orske  
alate

Akumulat  
orske  
lampe i  
pribor









Pribor za  
laserske  
merace

Pribor za  
rušenje i  
udarno  
bušenje

Pribor za  
bušenje

## Kese za skupljanje prašine

### Kese za skupljanje prašine

Model	Naziv	Za model	Jedinica (kom/kompl)	Cena sa PDV-om	
122296-4	Kesa za prašinu	9924DB, 9900B	1		
122297-2	Kesa za prašinu	9401, 9402	1		
122329-5	Kesa za prašinu	9901	1		
122330-0	Kesa za prašinu	LS1440	1		
122469-9	Kesa za prašinu	1050D, 1051D	1		
122474-6	Kesa za prašinu	3901	1		
122548-3	Kesa za prašinu	9910, 9911	1		
122562-9	Kesa za prašinu	9403	1		

Nastavak...

Krunaste  
testere

Pribor za  
pritezanj  
e

Pribor za  
sečenje i  
bušenje

Pribor za  
bušenje  
i  
poliranje

Pribor za  
profilisanj  
e i  
poravnaj

Pribor za  
višenam  
enski alat

Pribor za  
testere

Pribor za  
pneumat  
ske alate

Pribor za  
fenove  
za vrući  
vazduh

Pribor za  
usisivanj  
e

Pribor za  
alate za  
rad na  
otvoreno

Pribor za  
držače  
alata i  
zaštitna















Koferi i  
torbe

Ručni  
alati

Ostalo













Pribor za  
mješanje

# Pribor za usisivanje

	Model	Naziv	Za model	Jedinica (kom/kompl)	Cena sa PDV-om
	122591-2	Kesa za prašinu	9404, 9920, 9903	1	
	122708-7	Kesa za prašinu	HR2432	1	
	122793-0	Kesa za prašinu	KP0810, KP0810C, KP0800, BKP180, DKP180	1	
	122852-0	Kesa za prašinu	DLS713, LS1016, LS1016L, LS1216, LS1216L, LH1040, LH1040F, LS1018, DLS211, LS003G	1	
	122853-8	Kesa za prašinu	PC5000C, PC5001C	1	
	122884-7	Kesa za prašinu	DLS600	1	
	123150-5	Kesa za prašinu	PJ7000	1	
	123185-6	Kesa za prašinu	4105KB	1	
	123328-0	Kesa za prašinu	M9400	1	
	126599-8	Kesa za prašinu	DSP600, DSP601	1	
	126738-0	Kesa za prašinu	4100KB, DCC500		
	135132-5	Kesa za prašinu	MT941	1	
	135222-4	Kesa za prašinu	BO4555, BO4556, BO4565, BO4566, MT924	1	
	135246-0	Kućište kese za prašinu sa kesom	DBO140, DBO180, BO4555, BO4556, BO4557, BO4558, BO4565, BO4566, BO5030, BO5031, BO5040, BO5041	1	

[Nastavak...](#)

# Pribor za usisivanje

Model	Naziv	Za model	Jedinica (kom/kompl)	Cena sa PDV-om	
136402-5	Kesa za prašinu	M9204	1		
140115-2	Kesa za prašinu	BO3710, BO3711	1		
168557-8	Kesa za prašinu	BO3710, BO3711	1		
191C21-2	Kesa za prašinu	DKP181, KP001G	1		
193293-7	Papirna Kesa za prašinu	9046,BO6030, BO5020, BO5021, BO3700, BO4900V	5/1		
193294-5	Držač za papirnatu kesu za prašinu	9046, BO3700, BO4900V, BO6030, BO5021	2/1		
193712-3	Papirna Kesa za prašinu	BO4553, BO4554, BO4561, BO4563, BO5011, BO5011, BO5012, BO5010, BO5011	5/1		
194175-6	Ciklonsko spremište za prašinu za potežno-nagibnu testeru	LS0714, LS0714F, LS0714FL, LS0814FL, LS1216, LS1216FL, LS1216L	1		
194746-9	Papirna Kesa za prašinu	BO4565, BO4555, BO4557, BO3700, BO3710, BO3711, BO5030, BO5031, BO5041, BBO180	5/1		
196299-4	Kesa za prašinu	N1923B	1		
196300-5	Kesa za prašinu	1911B	1		
JM23100501	Kesa za prašinu	LS1018L, LH1200FL	1		
STEX122269	Kesa za prašinu	1902	1		

Akumulat  
ori i  
punjači

Pribor za  
akumulat  
orske  
alate

Akumulat  
orske  
lampe i  
pribor

Pribor za  
laserske  
merace

Pribor za  
rušenje i  
udarno  
bušenje

Pribor za  
bušenje

Krunaste  
testere

Pribor za  
pritezanje

Pribor za  
sečenje i  
brusjenje

Pribor za  
brusjenje  
i  
poliranje

Pribor za  
profilisanje  
i  
poravnane

Pribor za  
višenam  
enski alat

Pribor za  
testere

Pribor za  
pneumat  
ske alate

Pribor za  
fenove  
za vrući  
vazduh

Pribor za  
usisivanje

Pribor za  
alate za  
rad na  
otvoreno

Pribor za  
držače  
alata i  
zaštitna

Koferi i  
torbe













Ručni  
alati

Ostalo

Pribor za  
mješanje

# Pribor za usisivanje

## Filter kese za usisivače

	Model	Naziv	Za model	Jedinica (kom/kompl)	Gena sa PDV-om
	122918-6	Kesa za prašinu	DVC340, DVC350	1	
	143677-9	Držač vreće za prašinu	DCL182, DCL182F, CL121D, CL107FD, CL105D, CL104D, CL072D, CL121D	1	
	161471-7	Papirnata filter kesa	VC008G	1	
	1910M4-5	Kesa za prašinu	CL002G	1	
	191C26-2	Kesa za prašinu	DVC660, DVC665	10/1	
	191C30-1	Kesa za prašinu	DVC660, DVC665	1/1	
	191D63-2	Kesa za prašinu	DVC560	10/1	
	192632-8	Papirni filter komplet	4072D, 4073D, 4013D, 4093D, CL102D, CL104D, CL107FD, DCL142, DCL182, DCL184, CL002G	5/1	
	195432-5	Plastična kesa za usisivač	DVC150L, DVC151L, DVC155L, DVC156L, DVC157L, DVC860L, DVC861L, DVC865L, DVC866L, DVC867L, VC1310L, VC001G, VC003G, VC004G, VC005G	10/1	
	195440-6	Plastična kesa za usisivač	VC2510L, VC3210L, VC3211H, VC3211M, VC2211M	10/1	
	195557-5	Papirna kesa za usisivač	DVC150L, DVC151L, DVC155L, DVC156L, DVC157L, DVC860L, DVC861L, DVC865L, DVC866L, DVC867L, VC1310L, VC2510L, VC001G, VC003, VC004G, VC005G	5/1	
	195558-3	Papirna kesa za usisivač	VC3210L, VC3211H, VC3211M, VC2211M	5/1	
	197899-3	Kesa za usisivač	DVC260, DVC261, DVC265	1	

[Nastavak...](#)

# Pribor za usisivanje

Model	Naziv	Za model	Jedinica (kom/kompl)	Cena sa PDV-om	
197903-8	Papirna kesha za usisivač	DVC260, DVC261 , DVC265	10/1		
198747-9	Filter	DCL282F, DCL182, DCL182F, CL121D, CL107FD, CL105D, CL104D, CL072D, CL121D, DCL184, CL002G	1		
198749-5	Kesa za prašinu	DCL282F, DCL182, DCL182F, CL121D, CL107FD, CL105D, CL104D, CL072D, CL121D, CL002G	1		
198753-4	Kesa za prašinu	CL107DF, DCL181	1		
83132B8I	Papirna kesha za usisivač	440	5/1		
83133B8K	Papirna kesha za usisivač	440	5/1		
83134B8I	Papirna kesha za usisivač	448	5/1		
83139H0B	Plastična kesha za usisivač	449	5/1		
P-70194	Papirna kesha za usisivač	446L	5/1		
P-70203	Papirna kesha za usisivač	447L, 447M	5/1		
P-70297	Plastična kesha za usisivač	446L, VC2012L, VC2512L, VC3011L, VC3012L/M, VC2010L, VC2511, VC3511L, VC2000L	5/1		
P-70306	Plastična kesha za usisivač	447L, 447M	5/1		
P-72899	Papirna kesha za usisivač	VC2012L, VC2512L, VC3011L, VC2010L, VC2511, 446L, VC2000L	5/1		
P-78293	Papirna kesha za usisivač	VC3511L	5/1		

Nastavak...

Akumulat  
ori i  
punjači

Pribor za  
akumulat  
orske  
alate

Akumulat  
orske  
lampe i  
pribor

Pribor za  
laserske  
merace

Pribor za  
rušenje i  
udarno  
bušenje

Pribor za  
bušenje

Krunaste  
testere

Pribor za  
pritezanj  
e

Pribor za  
sečenje i  
brusenje

Pribor za  
brusenje  
i  
poliranje

Pribor za  
profilisanj  
e i  
poravnaj

Pribor za  
višenam  
enski alat

Pribor za  
testere

Pribor za  
pneumat  
ske alate

Pribor za  
fenove  
za vrući  
vazduh

Pribor za  
usisivanj  
e

Pribor za  
alate za  
rad na  
otvoreno

Pribor za  
držače  
alata i  
zaštitna

Koferi i  
torbe

Ručni  
alati

Ostalo

Pribor za  
mješanje

# Pribor za usisivanje

	Model	Naziv	Za model	Jedinica (kom/kompl)	Cena sa PDV-om
	P-84078	Kesa za prašinu	VC3012M / L, VC2512L, VC3011L	5/1	
	W107418353	Papirna kesa za usisivač	VC4210L/M	5/1	
	W107418354	Mikrofiberska vreća za filter	VC4210L/M	1	
	W107418355	5 plastičnih vreća za filter	VC4210L/M	5/1	
	W28547	Papirna kesa za usisivač	443	5/1	

# PRIBOR ZA ALATE ZA RAD NA OTVORENOM



## Lančane testere

## Mačevi



Model	Naziv	Dužina vodilice (mm)	Korak (")	Debljina vodjice lanca (mm)	Broj članaka	Cena sa PDV-om
161848-6	Vodilica sa lančanikom	200	3/8	1,1	33	
161846-0	Vodilica sa lančanikom	250	3/8	1,1	40	
165695-7	Vodilica sa lančanikom	250	3/8	1,3	39	
168407-7	Vodilica za rezbarske poslove	250	1/4	1,3	60	
168408-5	Vodilica za rezbarske poslove	250	3/8	1,3	40	
191G22-4	Vodilica	250	3/8	1,3	40	
165200-0	Vodilica	300	3/8	1,3	46	
165245-8	Vodilica sa lančanikom	300	3/8	1,1	46	
165201-8	Vodilica sa lančanikom	350	3/8	1,3	52	
165246-6	Vodilica sa lančanikom	350	3/8	1,1	52	
165456-5	Vodilica sa lančanikom	350	3/8	1,3	52	
161420-4	Vodilica sa lančanikom	380	0,325	1,3	64	
443038651	Vodilica sa lančanikom	380	3/8	1,5	56	
445038631	Vodilica sa lančanikom	380	0,325	1,5	64	
445038651	Vodilica sa lančanikom	380	3/8	1,5	56	
445038655	Vodilica sa lančanikom	380	3/8	1,5	60	
165202-6	Vodilica sa lančanikom	400	3/8	1,3	56	
165247-4	Vodilica sa lančanikom	400	3/8	1,1	56	
165390-9	Vodilica sa lančanikom	450	3/8	1,3	62	
444045141	Vodilica sa lančanikom	450	0,325	1,3	72	
445045651	Vodilica sa lančanikom	450	3/8	1,5	64	
445045655	Vodilica sa lančanikom	450	3/8	1,5	68	
445050655	Vodilica sa lančanikom	500	3/8	1,5	72	
443053651	Vodilica sa lančanikom	530	3/8	1,5	72	
445060455	Vodilica sa tvrdim vrhom	600	3/8	1,5	84	
445070455	Vodilica sa tvrdim vrhom	700	3/8	1,5	94	

## Lanci



Model	Dužina vodilice (mm)	Korak (")	Debljina vodjice lanca (mm)	Broj članaka	Prečnik turpije (mm)	Za model	Cena sa PDV-om
791284-8	160	1/4	1,3	42	4,0-4,0	DUC121, DUC122	
199076-3	200	3/8	1,1	33		DUC254	
194098-8	250	1/4	1,3	60	4,0-4,0	DUC256C, DUC254C	
196142-7	250	3/8	1,3	39	4,0-4,0	EY2650H25H	
196205-9	250	3/8	1,3	40	4,0-4,0	DCS232T, DUC250, DUC302	
199075-5	250	3/8	1,1	40		DUC254, DUC256, DUC306, DUA301	
531291646	300	3/8	1,1	46	4,0-4,0	DUC302, UC3041A, DUC256, DUC306, DUA301	
531492646	300	3/8	1,3	46	4,0-4,0	UC3051A, UC3551A, UC4051A, UC4551A, EA3200S, EA3201S, EA3500S, EA3500F	
528086656	330	0,325	1,5	56	4,8-4,5	EA5000P, EA5001P	
531291652	350	3/8	1,1	52	4,0-4,0	DUC353, UC3541A	

[Nastavak...](#)



# Pribor za alate za rad na otvorenom

289

Model	Dužina vodilice (mm)	Korak (")	Debljina vodilice lanca (mm)	Broj članaka	Prečnik turpije (mm)	Za model	Cena sa PDV-om
531492652	350	3/8	1,3	52	4,0-4,0	EA3200S, EA3201S, EA3500S, EA3500F, UC3051A, UC3551A, UC4051A, UC4551A	
528086664	380	0,325	1,5	64	4,8-4,5	DCS5121-45, EA5000P, EA5001P, EA5600F, EA6100P, EA6101P	
528099656	380	3/8	1,5	56	5,5-4,8	DCS5121-45, EA5000P, EA5001P, EA6100P, EA6101P	
532484064	380	0,325	1,3	64	4,8-4,5	EA4300F	
534686064	380	0,325	1,5	64	4,8-4,5	DCS5121-45, EA5000P, EA5001F, EA6100P, EA6101P	
196213-0	400	3/8	1,3	56	4,5-4,0	UC3541A, UC3051A, UC3551A, UC4051A, UC4551A, EA3200S, EA3201S, EA3501S, EA3502S, EA3600F, EA3601F, EA4300F	
531291656	400	3/8	1,1	56	4,0-4,0	UC4020A, UC4030A, UC4041A	
523093664	450	3/8	1,5	64	5,5-4,8	DCS5121-45, EA5000P, EA5001P, EA6100P, EA6101P, EA5600F	
528086672	450	0,325	1,5	72	4,8-4,5	DCS5121-45, EA5000P, EA5001F, EA6100P, EA6101P, EA5600F	
528099664	450	3/8	1,5	64	5,5-4,8	DCS5121-45, EA5000P, EA5001P, EA6100P, EA6101P	
531492662	450	3/8	1,3	62	4,0-4,0	UC3051A, UC3551A, UC4051A, UC4551A	
532484072	450	0,325	1,3	72	4,8-4,5	EA4300F, EA4301F	
534686072	450	0,325	1,5	72	4,8-4,5	DCS5121-45, EA5000P, EA5001F, EA6100P, EA6101P, EA5600F	
528099672	530	3/8	1,5	72	5,5-4,8	DCS5121-45, EA5000P, EA5600F, EA5001P, EA6100P, EA6101P, EA7300P, EA7900P	
528099680	600	3/8	1,5	80	5,5-4,8	DCS9010EA6100P, EA6101P	
528099684	600	3/8	1,5	84	5,5-4,8	DCS6400, EA6100P, EA6101P	



## Štitnici za mač

Model	Naziv	Dužina vodilice (mm)	Cena sa PDV-om
416311-7	Štitnici za mač	160	
418845-6	Štitnici za mač	250	
419242-9	Štitnici za mač	400 - 450	
419288-5	Štitnici za mač	300 - 350	
419559-0	Štitnici za mač	300 - 350	
419560-5	Štitnici za mač	350 - 450	
952020640	Štitnici za mač	350 - 450	
952020650	Štitnici za mač	450 - 530	
952020660	Štitnici za mač	600	

Akumulat  
ori  
punjači

Pribor za  
akumulat  
orske  
alate

Akumulat  
orske  
lampe i  
pribor

Pribor za  
laserske  
merace

Pribor za  
rušenje i  
udarno  
bušenje

Pribor za  
bušenje

Krunaste  
testere

Pribor za  
pritezani  
e

Pribor za  
sečenje i  
brusenje

Pribor za  
brusenje  
i  
poliranje

Pribor za  
profilisanj  
e i  
poravnaj

Pribor za  
višenam  
enski alat

Pribor za  
testere

Pribor za  
pneumat  
ske alate

Pribor za  
fenove  
za vrući  
vazduh

Pribor za  
usisivanj  
e

Pribor za  
alate za  
rad na  
otvoreno

Pribor za  
držače  
alata i  
zaštitna

Koferi i  
torbe

Ručni  
alati

Ostalo

Pribor za  
mješanje

# Pribor za alate za rad na otvorenom



















## Teleskopski nastavci za akumulatorske lančane testere

	Model	Naziv	Veličina (mm)	Opis	Za model	Cena sa PDV-om
	195595-7	Teleskopski nastavak, 1.800 - 2.600 mm	1.800x2.600	Pogodan za BL1815N, BL1820B, BL1830B.	DUC122	

## Sigurnosni kompleti i klinovi

	Model	Naziv	Dužina (D) (mm)	Cena sa PDV-om
	988070819	Plastični klin, 200 mm	200	
	988070824	Plastični klin, 240 mm	250	













## Alat za održavanje lančane testere

	Model	Naziv	Jedinica (kom/kompl)	Cena sa PDV-om
	744003-1	Turpija, 4 mm	1	
	950112031	Alat za rastavljanje lanca	1	
	953003040	Okrugle tuprije bez drške 5,5 mm	1	
	953004010	Drška za turpiju	1	
	953008020	Drška turpije	1	
	953009000	Okrugle tuprije sa drškom 5,5 mm	1	
	953030010	Okrugle tuprije sa drškom 4 mm	1	
	953030020	Okrugle tuprije sa drškom 4,5 mm	1	
	953030030	Okrugle tuprije sa drškom 4,8 mm	1	
	953030040	Oštrač lanca	1	
	D-67359	Okrugle tuprije bez drške 4,0 mm	2/1	
	D-67371	Okrugle tuprije bez drške 4,5 mm	2/1	
	D-67393	Okrugle tuprije bez drške 4,8 mm	2/1	
	D-67402	Okrugle tuprije bez drške 4,8 mm	12/1	
	D-67424	Okrugle tuprije bez drške 5,2 mm	12/1	
	D-67430	Okrugle tuprije bez drške 5,5 mm	2/1	
	D-67446	Okrugle tuprije bez drške 5,5 mm	12/1	
	D-67452	Pljosnata turpija za oštrenje lanca 15 mm	1	





[Nastavak...](#)

# Pribor za alate za rad na otvorenom

291

Model	Naziv	Jedinica (kom/kompl)	Cena sa PDV-om	
D-67474	Kontrolnik za lanac 143mm	1		
D-67480	Stega za vodilicu	1		
D-72154	Set za brušenje lanca 4.0 mm u vrećici	1		
D-72160	Set za brušenje lanca 4.5 mm u vrećici	1		
D-72176	Set za brušenje lanca 4.8 mm u vrećici	1		
D-72182	Set za brušenje lanca 5.2 mm u vrećici	1		
D-72198	Set za brušenje lanca 5.5 mm u vrećici	1		
D-73748	Turpija 4.0mm	1		
D-73754	Turpija 4.5mm	1		
D-73760	Turpija 4.8mm	1		
D-73776	Turpija 5.2mm	1		
D-73782	Turpija 5.5mm	1		

## Ulja i posude

Model	Naziv	Zapremina (l)	Cena sa PDV-om	
195532-1	Ulje za 4-taktne motore, 10W-30	0,22		
197007-6	Motorno ulje za 4-taktne motore, SL10W-40, 80ml	0,08		
980008606	Motorno ulje za 2-taktne motore	0,1		
980008607	2-taktno motorno ulje	1		

Nastavak...

Akumulat  
ori i  
punjači

Pribor za  
akumulat  
orske  
alate

Akumulat  
orske  
lampe i  
pribor

Pribor za  
laserske  
merace

Pribor za  
rušenje i  
udarno  
bušenje

Pribor za  
bušenje

Krunaste  
testere

Pribor za  
pritezanje

Pribor za  
sečenje i  
brusjenje

Pribor za  
brusjenje  
i  
poliranje

Pribor za  
profilisanje  
i  
poravnanje

Pribor za  
višenam  
enski alat

Pribor za  
testere

Pribor za  
pneumat  
ske alate

Pribor za  
fenove  
za vrući  
vazduh

Pribor za  
usisivanje

Pribor za  
alate za  
rad na  
otvoreno

Pribor za  
držače  
alata i  
zaštitna

Koferi i  
torbe

Ručni  
alati







Ostalo

Pribor za  
mješanje

# Pribor za alate za rad na otvorenom

	Model	Naziv	Zapremina (l)	Cena sa PDV-om
	980008610	Biotop ulje za lanac	1	
	980008612	2-taktno motorno ulje 50:1,1L sa mernim poklopcem	1	
	980508620	Motorno ulje za 4-taktno motore	0,6	
	988602656	Ulje za lanac	1	
	988602658	Ulje za lanac	5	

## Kombinovane posude za gorivo

	Model	Naziv	Kapacitet rezervoara za ulje (l)	Kapac. rezervoara za gorivo (l)	Cena sa PDV-om
	949000030	Kombiniran kanister za gorivo i ulje - crveni	3	5	
	949000034	Kombiniran kanister za gorivo -zeleni	1,5	3,5	
	949000035	Kombiniran kanister za gorivo i ulje - beli	3	5	
	949000036	Kombiniran kanister za gorivo i ulje - prozorni	3	5	
	949000050	Dodatak za sipanje	/	/	
	949100035	Dodatak za sipanje ulja	/	/	
	949100036	Dodatak za sipanje goriva	/	/	

# PRIBOR ZA VIŠENAMENSKE ALATE

## 191E24-8

Nastavak za produženje  
LE400MP



## 191N39-9

Trimer glava  
EM408MP



## 191T38-7

Lančana testera  
EY403MP

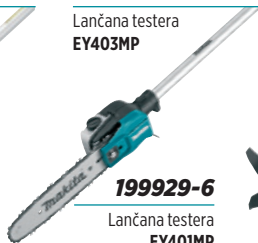

## 199183-2

Kultivator  
KR401MP



## 198062-1

Makaze za travu i živu ogradu  
EN420MP



## 196257-0

Makaze za živu ogradu  
EN401MP



## 197743-4

Prave makaze za živu ogradu  
EN410MP



## 196753-8

Nastavak za alata za ivice  
EE400MP



## 191M59-7

Rotirajuće makaze  
EM407MP



## 199341-0

Priključak za čišćenje  
SW400MP



## 199320-8

Četka-nastavak  
BR400MP



## 191P76-5

Duvalica-nastavak  
UB401MP



## UX01 / DUX60 / DUX18

122906-3	Naramenica
125516-5	Naramenica
126012-6	Naramenica
195638-5	Torba za alat

## EM408MP - trimer

198383-1	Rezna glava sa tri plastična noža 255 mm
198426-9	Plastični nož za 198383-1 (12/1)
191D89-4	Najlonska glava
B-14118	Rezni list 4 zuba - 230 mm
B-14130	Rezni list 8 zuba - 230 mm

## EY403MP - lančana testera

165245-8	Vodilica sa lančanicom 300/1,1 mm, 3/8"
531291646	Lanac 300/1,1 mm, 3/8"
419288-5	Poklopac za mač 300 mm

## EY401MP - lančana testera

165695-7	Vodilica sa lančanicom 250/1,3 mm, 3/8"
196142-7	Lanac 250/1,3 mm, 3/8"
418845-6	Poklopac za mač 250 mm

## EN420MP - makaze za travu i živu ogradu

458342-0	Poklopac noža
----------	---------------

## SW400MP - priključak za čišćenje

XNR0000549	Rezervni točak
------------	----------------

## BR400MP - četka-nastavak

XNR0000548	Rezervna najlonska četka
------------	--------------------------



## Noževi i zaštite makaza za živu ogradu

## A: ZAKRIVLJENO SEČIVO

Optimalan oblik sečiva za glatko sečenje



Oštre oštrice:  
Gornje sečivo je zakrivljeno nadole  
Donja oštrica je zakrivljena nagore

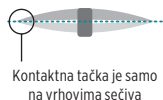

Kontaktna tačka je samo  
na vrhovima sečiva

Lako i čvrsto hvata grančice



Lako grabi



Čvrsto drži i seče

## B: VISOKOKVALITETNO SEČIVO

Gornje i donje sečivo sa  
3 veoma oštre ivice za glatko sečenjeSečivo sa 3 veoma oštre ivice za čiste rezove  
i minimalno oštećenje grana.

## C: OŠTRICA BEZ MRLJA

Premaz od nikla bez elektrolize

Ravnomerno i snažno prijanjajući površinski  
premaz sa visokom otpornošću na  
habanje za dugotrajan premaz.

Površina oštrice  
(posle 10 sati sečenja šimšira)

Oštrica bez mrlja



Druge oštrice

Za model	Dužina	Tip	Nož	Zaštita noža
DUM168, UM164D, UH200D	200 mm	/	195243-8	452055-5
UH200D, DUM168, UM164	200 mm	/	195272-1	458342-0
DUM604, UH201D, UM600D, UM603	200 mm	C	198408-1	458342-0
UH4261	420 mm	C	140826-9	9101MA0201
UH4570	450 mm	C	194660-9	450489-6
DUN461W, UN460WD	460 mm	/	191P00-8	413720-1
UH4861	480 mm	C	140830-8	452685-2
DUH483	480 mm	C	195768-2	452685-2
DUN500	500 mm	A	191C14-9	458413-3
EH5000W	500 mm	B	196795-2	452328-6
DUH501	500 mm	A	199098-3	458413-3
DUH502	500 mm	B	199598-3	459120-1
UH5261	520 mm	C	140827-7	452685-2
DUH523	520 mm	C	195769-0	452685-2
UH5570	550 mm	C	194663-3	450489-6
DUH551	550 mm	C	196687-5	450489-6
DUN600	600 mm	A	191C13-1	458414-1
DUH604	600 mm	A	191D38-1	412769-8
UH004G	600 mm	A	191R53-9	412911-1
UH006G	600 mm	B	191R55-5	412911-1
UH008G	600 mm	B	191R57-1	459121-9
UH013G	600 mm	A	191Y03-6	413B98-4
EH6000W	600 mm	B	196797-8	452327-8
DUH601	600 mm	A	199099-1	458414-1
DUH602	600 mm	B	199599-1	459121-9
UH6570	650 mm	C	194666-7	450490-1
UH6580, DUH651	650 mm	C	194673-0	450490-1
DUH651	650 mm	C	196688-3	450490-1
DUH754	750 mm	A	191D39-9	412770-3
UH005G	750 mm	A	191R54-7	412912-9
UH007G	750 mm	B	191R56-3	412912-9
UH009G	750 mm	B	191R58-9	459122-7
UH014G	750 mm	A	191Y05-2	413B99-2
UH7580	750 mm	C	194675-6	450490-1
EH7500W	750 mm	B	196799-4	452326-0
DUH751	750 mm	A	199100-2	412912-9
DUH752	750 mm	B	199600-2	459122-7

## Makaze za živu ogradu

### Sakupljač otpadaka



Model	Za model	Cena sa PDV-om
191D33-1	DUH604	
191D34-9	DUH754	
191R51-3	UH004G, UH006G, UH008G	
191R52-1	UH005G, UH007G, UH009G	
191T43-4	DUN461W, UN460WD	
194681-1	DUH551, DUH651, UH4570, UH5570, UH5580, UH6580, UH6850, UH7580	
195050-9	DUH483, DUH523, UH4260, UH4261, UH4860, UH4861, UH5260, UH5261	
195279-7	UH200D, UM164, DUM168	
195321-4	EH6000W, EH7500S, EH7500W	
198401-5	DUM604, UH201, UM600D, UM603D, UM164, DUM111, UM110D	
199151-5	DUH501, DUH502, DUH601, DUH602, DUH751, DUH752	

### Držač za kabl



Model	Naziv	Za model	Cena sa PDV-om
158024-1	Držač za kabl	UH4261, UH4570, UH4861, UH5570, UH5261, UH5580, UH6570, UH6580, UH7580	
194677-2	Držač za kabl	UH4261, UH4570, UH4861, UH5570, UH5261, UH5580, UH6570, UH6580, UH7580	
194679-8	Stezač kabla sa kaišem za ruku	UH4261, UH4570, UH4861, UH5570, UH5261, UH5580, UH6570, UH6580, UH7580	



Akumulat  
ori i  
punjači

Pribor za  
akumulat  
orske  
alate

Akumulat  
orske  
lampe i  
pribor

Pribor za  
laserske  
merace

Pribor za  
rušenje i  
udarno  
bušenje

Pribor za  
bušenje

Krunaste  
testere

Pribor za  
pritezani  
e

Pribor za  
sečenje i  
brusjenje

Pribor za  
brusjenje  
i  
poliranje

Pribor za  
profilisanj  
e i  
poravnav

Pribor za  
višenam  
enski alat

Pribor za  
testere

Pribor za  
pneumat  
ske alate

Pribor za  
fenove  
za vrući  
vazduh

Pribor za  
usisivanj  
e

Pribor za  
alate za  
rad na  
otvoreno

Pribor za  
držače  
alata i  
zaštitna

Koferi i  
torbe



Ručni  
alati

Ostalo

Pribor za  
mješanje









## Sredstva za podmazivanje

## Sredstva za podmazivanje

	Model	Naziv	Pogodno za	Cena sa PDV-om
	197439-7	Mazivo za teleskopske makaze za živu ogradu i za priključke za više alata	Idealno za teleskopske makaze za živu ogradu i za priključke za više alata.	
	199450-5	Mast za podmazivanje trimera u tubi	Idealno za Makita kosilice za žbunje, motorne kose i makaze za orezivanje.	

## Akumulatorske makaze za travu

## Pribor

	Model	Naziv	Za model	Cena sa PDV-om
	191N23-4	Nož za makaze 110 mm	DUM111, DUM110, UM110D	
	191N24-2	Nož za makaze 200 mm	DUM111, DUM110, UM110D	
	195187-2	Produžena drška	DUM166, DUM168, UM164D, UM165D, UM167D, UH200D	
	195267-4	Nož za makaze 160 mm	DUM168, UM164, UH200, DUM604, DUM600	
	198401-5	Sakupljač strugotine	DUM604, UH201, UM600D, UM603D, UM164, DUM111, UM110D	
	198486-1	Nastavak za makaze za travu sa točkovima	DUM604, UM600D, UM603D, UH2011D, DUM111, UM110D	
	452055-5	Poklopac noža za makaze	DUM168, UM164, UH200D, DUM604, UM600D	
	452198-3	Poklopac noža za makaze	DUM111, UM110D	
	454880-0	Štitnik za travu	DUM111, DUM110, UM110D	

[Nastavak...](#)



# Pribor za alate za rad na otvorenom









297

Model	Naziv	Za model	Cena sa PDV-om	
457426-1	Štitnik za travu	DUM604, UM603D, UM600D, UM164, DUM168, UH200, DUM600, UH201		

## Akumulatorska makaza za orezivanje



## Akumulatorske makaze za orezivanje

Model	Naziv	Za model	Cena sa PDV-om	
161377-9	Rezervni kaiševi	DUP361, DUP362		
161379-5	Rezervna torbica za odlaganje makaze	DUP361, DUP362		
161603-6	Naramenica za akumulatore	DUP361, DUP362		
197366-8	Nož za makaze U-tip	DUP361, DUP362		
197367-6	Nož za makaze L-tip	DUP361, DUP362		
199168-8	Gornji nož za makaze za deblje grane, do 33 mm	DUP361, DUP362		
199169-6	Donji nož za makaze za deblje grane, do 33 mm	DUP361, DUP362		
199171-9	Donji nož za makaze za tanje grane, do 25 mm	DUP361, DUP362		
199314-3	Gornji nož za makaze za tanje grane, do 25 mm	DUP361, DUP362		

[Nastavak...](#)

Akumulatori i punjači

Pribor za akumulatorske alate

Akumulatorske lampe i pribor

Pribor za laserske merace

Pribor za rušenje i udarno bušenje

Pribor za bušenje

Krunaste testere

Pribor za pritezanje

Pribor za sečenje i brušenje

Pribor za brušenje i poliranje

Pribor za profilisanje i poravnanje

Pribor za višenamenski alat

Pribor za testere

Pribor za pneumatske alate

Pribor za fenove za vrući vazduh

Pribor za usisivanje

Pribor za alate za rad na otvorenom

Pribor za držače alata i zaštitna



Koferi i torbe

Ručni alati

Ostalo

Pribor za mješanje

# Pribor za alate za rad na otvorenom

	Model	Naziv	Za model	Cena sa PDV-om
	661445-3	Kabl za povezivanje	DUP361, DUP362	
	794530-8	Dijamantska turpija	DUP361, DUP362	



Akumulat ori i punjači
Pribor za akumulat orske alate
Akumulat orske lampe i pribor
Pribor za laserske merace
Pribor za rušenje i udarno bušenje
Pribor za bušenje
Krunaste testere
Pribor za pritezam e
Pribor za sečenje i brusenje
Pribor za brusenje i poliranje
Pribor za profilisan e i poravnav
Pribor za višenam enski alat
Pribor za testere
Pribor za pneumat ske alate
Pribor za fenove za vrući vazduh
Pribor za usisivanj e
Pribor za alate za rad na otvoreno
Pribor za držače alata i zaština
Koferi i torbe
Ručni alati
Ostalo
Pribor za mješanje

# SEČIVA I REZNE GLAVE

TIP	ZA NISKU I MLADU TRAVU	ZA VISOKU I STARIJU TRAVU	ZA GRMLJE
<b>Rezna glava</b> sa najlonskim koncem	←→		
<b>Rezna glava</b> sa tri plastična noža	←→		
<b>Rezni list,</b> 2 zuba	←→		
<b>Rezni list,</b> 4 zuba	←→		
<b>Rezni list,</b> 8 zuba	←→		
<b>Rezni list,</b> 3 zuba	←→		
<b>Sečivo za drobljenje,</b> 2 zuba		←→	
<b>Rezni list,</b> 80 zuba			←→
<b>Rezni list</b> oblik dleta			←→

## BRZO IZMENJIVE GLAVE TRIMERA

**Jednostavno nameštanje najlonske niti bez potrebe da rastavljate glavu trimera**



0 ————— vreme potrebno za nameštanje niti ————— 85 s

Standardne glave trimera					
	1. rastaviti glavu	2. namotajte najlonsku nit na točak	3. pričvrstite točak na glavu	4. sklopite glavu	5. gotovo







0 ————— vreme potrebno za nameštanje niti ————— 35 s

Brzo izmenjive glave trimera				
	1. poravnajte oznake trougla	2. ubacite nit	3. rotirajte dugme	4. gotovo











**do 58%**  
brže nameštanje

# NAJLONSKE NITI

OBLIK	OŠTRINA	ENERGETSKA EFIKASNOST	NIZAK NIVO BUKE
okrugla 		★	★
kvadratna 	★★		
četverolisna 	★	★★	★★

VRSTA SAJLICE Prečnik/Oblik	LAKŠI POSLOVI		ZAHTEVNIJI POSLOVI	
	Niska trava		Visoka trava	
	Niske gustine	Visoka gustina	Niske gustine	Visoka gustina
1,3 mm 	←→			
1,6-1,65 mm 	←→			
2,0 mm 		←→		
2,4 mm 		←→	←→	
2,7 mm 			←→	←→
3,0 mm 				←→

## Standardne najlonske niti

MODEL	Boja/Oblik	Slojevi	Debljina	Dužina
E-02727		Jednoslojna	1,3 mm	15 m
E-02733		Jednoslojna	1,6 mm	15 m
E-02705		Jednoslojna	2 mm	15 m
E-02711		Jednoslojna	2 mm	126 m
E-02749		Jednoslojna	2,4 mm	15 m
E-02761		Jednoslojna	2,4 mm	87 m
E-02783		Jednoslojna	2,4 mm	262 m
E-02808		Jednoslojna	2,4 mm	15 m
E-02814		Jednoslojna	2,4 mm	69 m
E-02820		Jednoslojna	2,4 mm	206 m

## Četverolisna najlonska nit

Nizak nivo buke i energetska efikasna



### Četvorolisni oblik

Specijalni četvorokraki oblik stvara mali vrtlog prilikom okretanja, koji smanjuje otpor vazduha, stvara manje buke i efikasniji je u potrošnji energije. Idealan za akumulatorske trimere.

### Okrugli - protok vazduha

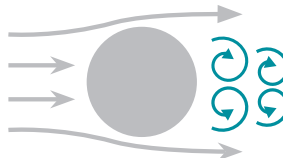

### Četvorolisni - protok vazduha

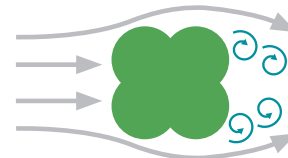

### Količina rada pri jednom punjenju aku.

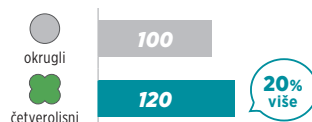

### Poređenje buke

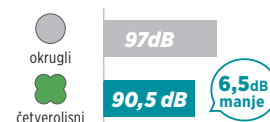







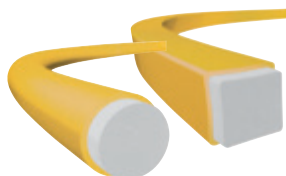





## Dvoslojne najlonske niti

Povećana izdržljivost do 130% \* zahvaljujući fleksibilnom jezgri i spoljnom sloju otpornom na udarce i habanje.

\*u poređenju sa standardnim najlonskim nitima



MODEL	Boja/Oblik	Slojevi	Debljina	Dužina
E-02836		Dvoslojni	3,0 mm	15 m
E-02842		Dvoslojni	3,0 mm	56 m
E-02858		Dvoslojni	3,0 mm	168 m
E-02870		Dvoslojni	3,0 mm	15 m
E-02886		Dvoslojni	3,0 mm	44 m
E-02892		Dvoslojni	3,0 mm	132 m

MODEL	Boja/Oblik	Slojevi	Debljina	Dužina
E-01731		Jednoslojna	1,65 mm	15 m
E-01747		Jednoslojna	1,65 mm	30 m
E-01753		Jednoslojna	1,65 mm	445 m
E-01769		Jednoslojna	2 mm	15 m
E-01775		Jednoslojna	2 mm	30 m
E-01781		Jednoslojna	2 mm	310 m
E-01797		Jednoslojna	2,4 mm	15 m
E-01806		Jednoslojna	2,4 mm	30 m
E-01812		Jednoslojna	2,4 mm	225 m
E-01828		Jednoslojna	2,7 mm	15 m
E-01834		Jednoslojna	2,7 mm	30 m
E-01840		Jednoslojna	2,7 mm	180 m

## Kose

### Rezne glave sa najlonskim koncem

Model	Naziv	Navoj	Prečnik Ø (mm)	Za model	Cena sa PDV-om	
122882-1	Najlonska glava sa 2 konca sa udarnim nastavljanjem	M10X1,25	2,4	UH4350UH		
122931-4	Najlonska glava	M10X1,25 LH	2,4	EBH341R, EBH341L, EBH341U, EBH252, EBH253, EM2651L, EM2651U, RBC413, RBC414		
122977-0	Najlonska glava	M8 x 1.25	2,4	DBC260L		
123235-7	Najlonska glava	M8X1,25LH	2	DUR182L, DUR187, DUR188		
191D89-4	Glava za najlonsku sajlju M10x1,25LH, 2mm	M10x1,25LH	2	UR101C, DUR190L, DUR190U, DUR191L, DUR191U, DUR194, UR201C, UR202C, UR002G, DUR365, DUR366, DUR368L, DUR369A, DUR369L, DUR369N		
191D90-9	Glava za najlonsku sajlju M10x1,25LH, 2,4mm	M10x1,25LH	2,4	EBH252L, EBH252U, EBH253L, EHB253U, EM2510L, EM2511L, EM3650U, EM2651L, EM2651U, EM2653L, EM2654L, EM400MP, EM401MP, EM403MPEM404MP, EM405MP, EM406P, UR101C, UR201C, UR202C, DUR369A, DUR369L, DUR369N		
191D92-5	Glava za najlonsku sajlju M8x1,25RH, 2mm	M8x1,25 RH	2	DUR189		
191Y39-5	Najlonska rezna glava	/	1,65	DUR193		
195149-0	Najlonska glava sa 2 konca sa udarnim nastavljanjem	M10x1,25 LH	2,4	BBC231U, EBH252U, EBH253U, EM2651UH, BUX361, DUR365U, DUR366L		
196146-9	Najlonska rezna glava	/	2	DUR141, DUR181, UR140D, UR180D		
196324-1	Najlonska glava	M10x1,25L	2,4	EM2654LH, UR002G		
197030-1	Najlonska rezna glava	M10x1,25LH	3,0	EBH341U/L/R, EM4350UH/LH/RH, EM4351UH, RBC411U, RBC412U, RBC413U, RBC414U		

Nastavak...

 Akumulat  
ori i  
punjači

 Pribor za  
akumulat  
orske  
alate

 Akumulat  
orske  
lampe i  
pribor

 Pribor za  
laserske  
merace

 Pribor za  
rušenje i  
udarno  
bušenje

 Pribor za  
bušenje

 Krunaste  
testere

 Pribor za  
pritazani  
e

 Pribor za  
sečenje i  
brusjenje

 Pribor za  
brusjenje  
i  
poliranje

 Pribor za  
profilisanje  
i  
poravnav

 Pribor za  
višenam  
enski alat

 Pribor za  
testere

 Pribor za  
pneumat  
ske alate

 Pribor za  
fenove  
za vrući  
vazduh

 Pribor za  
usisivanje

 Pribor za  
alate za  
rad na  
otvoreno

 Pribor za  
držače  
alata i  
zaštitna

 Koferi i  
torbe

 Ručni  
alati

Ostalo

 Pribor za  
mješanje

## Pribor za alate za rad na otvorenom

	Model	Naziv	Navoj	Prečnik Ø (mm)	Za model	Cena sa PDV-om
	197993-1	Glava za najlonsku nit	M10x1,25LH	2,4	UR006G, UR007G, UR012G, DUR369, UR101, UR201	
	198266-5	Glava za najlonsku nit	M10x1,25LH	2,4	UR007, UR006, DUR369, UR101, UR201	
	198385-7	Najlonska glava	M8X1,25LH	2	DUR187L/U, DUR188L/U, DUR182	
	198854-8	Najlonska glava	M8x1.25RH	1,65	UR100D	
	198893-8	Najlonska glava	95-M10L	2	DUR190, DUR191, DUR192L, DUDUR365U, DUR366L, DUR368A/L, DUR369A/L, EBH252U/L, EBH253U/L, EM2510LH, EM2511LH, EM2850UH/ LH, EM2651UH/LH, EM2653LH, EM2654LH, UR101C, UR201C, UR202C, UR002G, UR003G, UR006G, UR007G, EM400MP, EM401MP, EM403MP, EM404MP, EM405MP	
	198971-4	Najlonska rezna glava	M8x1.25RH	2	DUR189	
	384224503	Glava za košenje sa dva konca	M10x1,25 LH	3	DBC4010, DBC4510	
	957385030	Najlonska glava	M12X1,5LH	2	DBC4010, DBC4510	
	B-01959	Najlonska rezna glava	M8	2	RBC261	
	B-02945	Najlonska glava sa 2 konca sa automatskim nastavljanjem	M8&M10x1,25 LH	2,4	Univerzalna leva	
	B-03006	Najlonska rezna glava	M8&M10X 1,25 RH	2	Univerzalna desna	
	DA00000454	Najlonska rezna glava	M8X1,25LH	2,5	EM2600L, EM2600U	
	YA00000649	Najlonska glava	M8X1,25	2	UR3500, UR3501	







Nastavak...

# Pribor za alate za rad na otvorenom





303

Model	Naziv	Navoj	Prečnik Ø (mm)	Za model	Cena sa PDV-om	
YA00000651	Najlonska glava Tap&Go	M8X1,25	1,65	UR3500, UR3501		

## Rezne glave sa plastičnim noževima

Model	Naziv	Navoj	Za model	Jedinica (kom/kompl)	Cena sa PDV-om	
198383-1	Rezna glava sa tri plastična noža	M8 & M10 x 1,25 LH, M8 x 1,25 RH	DUR190, DUR191, DUR194, DUR187L/U, DUR188L/U, DUR189, DUR364L, DUR365U, DUR366L, DUR368A/L, DUR369A/L/N, UR101C, UR201C, UR002G, UR003G, UR012G, EM403MP, EM404MP, EM405MP, EM406MP	1		
198426-9	Plastični nož		198383-1	12/1		
198848-3	Rezna glava sa plastičnim nožem	M8 x 1,25 RH	UR100D	1		
198851-4	Plastični nož		198848-3	5/1		
199868-0	Rezna glava sa tri plastična noža	M10 x 1.25 LH	UR012G	1		
199870-3	Plastični noževi		199868-0	12/1		

## Rezni listovi

Model	Naziv	Prečnik Ø (mm)	Prečnik nasadnog otvora Ø (mm)	Broj zuba	Za model	Cena sa PDV-om	
191M75-9	Nastavak - rotacione makaze EM407MP	230	/	/	DUR369, UR101C, UR201C, UR006G, UR007G, EM2511LH, EM2651UH, EM2654LH		
191W97-9	Komplet pribora za metalni nož	/	25,4	/	DUR190L, DUR190U, DUR191L, DUR191U		
195624-6	Rezni list	305	25,4	2	RBC414U		
198345-9	Nož za trimer (2zuba)	255	25,4	2	DUR369, UR101C, UR201C, UR006G, UR007G		

Nastavak...

Akumulat  
ori i  
punjači

Pribor za  
akumulat  
orske  
alate

Akumulat  
orske  
lampe i  
pribor

Pribor za  
laserske  
merace

Pribor za  
rušenje i  
udarno  
bušenje

Pribor za  
bušenje

Krunaste  
testere

Pribor za  
pritezanje

Pribor za  
sečenje i  
brusjenje

Pribor za  
brusjenje  
i  
poliranje

Pribor za  
profilisanje  
i  
poravnava

Pribor za  
višenam  
enski alat

Pribor za  
testere

Pribor za  
pneumat  
ske alate

Pribor za  
fenove  
za vrući  
vazduh

Pribor za  
usisivanje

Pribor za  
alate za  
rad na  
otvoreno

Pribor za  
držače  
alata i  
zaštitna

Koferi i  
torbe

Ručni  
alati

Ostalo

Pribor za  
mješanje

## Pribor za alate za rad na otvorenom

	Model	Naziv	Prečnik Ø (mm)	Prečnik nasadnog otvora Ø (mm)	Broj zuba	Za model	Cena sa PDV-om
	199874-5	Oštrica	270	25,4	2	UR012G	
	D-66058	Nož za trimer (2zuba) 230x2.0x2Tx25.4	230	25,4	2	DUR361U, DUR362U, EBH252U, EBH253U, EM2500U/L, EM2510LH, EM2511LH, EM2600U/L, EM2650LH/UH, EM2651LH/UH, EM2653LH, EM2654LH, EM400MP, EM401MP, EM402MP, EM403MP, EM404MP	
	D-66064	Nož za trimer (2zuba) 255x2.0x2Tx25.4	255	25,4	2	EBH340U/R, EBH341L/U/R, EM3400U/L, EM4350UH/LH/RH, EM4351UH, RBC411U, RBC412U, RBC413U, RBC414U, DUR369A/L, UR101C, UR201C	
	195298-3	Rezni list	230	25,4	3	EM2600U/L, EM2650UH, EM2651UH, UR002G, UR006G, UR007G	
	195299-1	Rezni list	255	25,4	3	EBH341U, RBC411U, RBC412U, EM4351UH, EM4350UH/RH, EM3400U, UR006G, UR007G	
	385224350	Rezni list 3 zuba	225	20	3	DBC340	
	D-66020	Nož za trimer (3zuba) 230x3.0x3Tx25.4	230	25,4	3	EBH341U, RBC411U, RBC412U, EM4351UH, EM4350UH/RH, EM3400U	
	D-66036	Nož za trimer (3zuba) 257x3.0x3Tx25.4	257	25,4	3	EBH340U/R, EBH341L/U/R, EM3400U/L, EM4350UH/LH/RH, EM4351UH, RBC411U, RBC412U, RBC413U, RBC414U	
	D-66042	Nož za trimer (3zuba) 305x3.0x3Tx25.4	305	25,4	3	EBH341L/U, EM4350LH/UH, EM4351UH, RBC411U, RBC412U, RBC413U, RBC414U	
	372224140	Rezni list 4 zuba	200	20	4	DBC310	
	385224140	Rezni list 4 zuba	255	20	4	DBC4010, DBC4510	

Nastavak...



# Pribor za alate za rad na otvorenom

305

Model	Naziv	Prečnik Ø (mm)	Prečnik nasadnog otvora Ø (mm)	Broj zuba	Za model	Cena sa PDV-om	
B-14118	Rezni list 4 zuba	230	25,4	4	BBC231U, BUX361, DUR182, EBH341L/R/U, EBH252L/U, EBH253L/U, EM2600U, EM2651L/U, RBC2500, RBC3101, RBC420E, DUR361U, DUR365, DUR364, DUR366L, DUR368A/L		
B-14124	Rezni list 4 zuba	255	25,4	4	EBH341U/L/R, RBC420E		
D-66008	Nož za trimer (4zuba) 230x1.8x4Tx25.4	230	25,4	4	BBC231U, BUX361, DUR182, EBH341L/R/U, EBH252L/U, EBH253L/U, EM2600U, EM2651L/U, RBC2500, RBC3101, RBC420E, DUR361U, DUR365, DUR364, DUR366L, UR003G		
D-66014	Nož za trimer (4zuba) 255x2.0x4Tx25.4	255	25,4	4	ER2550LH		
191Y44-2	Rezni list 8 zuba	200	25,4	8	DUR194		
380224180	Rezni list 8 zuba	200	20	8	DBC300, DBC310		
385224180	Rezni list 8 zuba	250	20	8	DBC4010D, DBC4510D		
6418501900	Rezni list	255	25,4	8	EBH341R, EM4350UH/RH, EM4351UH, EM3400U		
B-14130	Rezni list 8 zuba	230	25,4	8	DUR182, DUR366L, EBH341U/L/R, EBH252L/U, EBH253L/U, EM2600U, EM2651L/U, RBC2100, RBC2110, RBC2500, RBC3101, RBC420E		
199872-9	Rezni list	225	25,4	24	UR012G		
385224161	Rezni list	255	20	24	DBC4010, DBC4510		
B-14152	Rezni list	230	25,4	80	EBH252L/U, EBH253L/U, EBH341U/L/R, EBH341L/R, EM2651L/U, RBC2500, RBC3101, RBC420E		

Akumulat  
ori i  
punjači

Pribor za  
akumulat  
orske  
alate

Akumulat  
orske  
lampe i  
pribor

Pribor za  
laserske  
merace

Pribor za  
rušenje i  
udarno  
bušenje

Pribor za  
bušenje

Krunaste  
testere

Pribor za  
pritazani  
e

Pribor za  
sečenje i  
brusjenje

Pribor za  
brusjenje  
i  
poliranje

Pribor za  
profilisanje  
i  
poravnava

Pribor za  
višenam  
enski alat

Pribor za  
testere

Pribor za  
pneumat  
ske alate

Pribor za  
fenove  
za vrući  
vazduh

Pribor za  
usisvanje

Pribor za  
alate za  
rad na  
otvoreno

Pribor za  
držače  
alata i  
zaštitna







Koferi i  
torbe

Ručni  
alati

Ostalo

Pribor za  
mješanje

## Zaštitni poklopci

	Model	Naziv	Za model	Gena sa PDV-om
	010341612	Štitnik	DBC4010D, DBC4510D	
	135398-7	Štitnik	EBH250U, EBH252U, EBH253U, EBH341U, EM2650UH, EM2651UH	
	135753-3	Štitnik	EBH252, EBH253, EBH341, EM2651, EM2654, EM4350, EM4351	
	135950-1	Štitnik	UR100D	
	140424-9	Štitnik	EM3400U/L, EM4350, EM4351	
	140583-9	Štitnik	BBC231U, BC231UD	
	140X35-4	Produžetak štita	EM408MP	
	141015-9	Štitnik	ER2550LH	
	144316-4	Štitnik	UR101C, UR201C, DUR369A, DUR369L	
	191B54-1	Štitnik	DUR369A, DUR369L, UR101C, UR201C, UR003G	
	196577-2	Štitnik	DUR182L	
	197294-7	Štitnik rezne glave	DUR368A, DUR368L	
	197295-5	Štitnik najlonske glave	DUR365U, DUR368A/L, UR003G	

[Nastavak...](#)

# Pribor za alate za rad na otvorenom

307

Model	Naziv	Za model	Cena sa PDV-om	
197806-6	Štitnik najlonske glave	EM2511LH		
199873-7	Štitnik za oštricu	UR012G		
199875-3	Štitnik za oštricu	UR012G		
412392-9	Štitnik	DUR190L, DUR190U, DUR191L, DUR191U		
412580-8	Štitnik	DUR192L		
412969-0	Štitnik	EM408MP		
413F73-4	Štitnik	DUR193		
450573-7	Futrola za alat	EBH252U		
451252-0	Futrola za sekač	EBH341U, EM2650UH, EM2651UH		
451566-7	Štitnik	BBC231U, BC231UD		
451878-8	Štitnik	EM3400U/L		
452259-9	Štitnik	EBH341U, EM4350UH, EM4351UH, RBC413U		
452260-4	Štitnik	EBH252U, EBH253U, EM2650UH, EM2651UH, EM2654LH, EM2511LH		
453353-0	Štitnik najlonske glave	DUR181		

Nastavak...

Akumulat  
ori i  
punjači

Pribor za  
akumulat  
orske  
alate

Akumulat  
orske  
lampe i  
pribor

Pribor za  
laserske  
merace

Pribor za  
rušenje i  
udarno  
bušenje

Pribor za  
bušenje

Krunaste  
testere

Pribor za  
pritezanje

Pribor za  
sečenje i  
brusenje

Pribor za  
brusenje  
i  
poliranje

Pribor za  
profilisanje  
i  
poravnanje

Pribor za  
višenam  
enski alat

Pribor za  
testere

Pribor za  
pneumat  
ske alate

Pribor za  
fenove  
za vrući  
vazduh

Pribor za  
usisivanje

Pribor za  
alate za  
rad na  
otvoreno

Pribor za  
držače  
alata i  
zaštitna













Koferi i  
torbe

Ručni  
alati

Ostalo



Pribor za  
mješanje

# Pribor za alate za rad na otvorenom





	Model	Naziv	Za model	Cena sa PDV-om
Akumulat ori punjači				
Pribor za akumulat orske alate	 454640-0	Štitnik	DUR182L	
Akumulat orske lampe i pribor	 455172-0	Štitnik	DUR361U	
Pribor za laserske merace	 455622-5	Štitnik	DUR364L	
Pribor za rušenje i udarno bušenje	 455815-4	Štitnik	DUR365U, DUR368A/L	
Pribor za bušenje	 455926-5	Štitnik	DUR365, DUR366	
Krunaste testere	 456651-1	Štitnik	DUR184L	
Pribor za pritezanj e	 457271-4	Štitnik	UR101C, UR201C, DUR369A, DUR369L	
Pribor za sečenje i brusenje	 457324-9	Štitnik	DUR187, DUR188	
Pribor za brusenje i poliranje	 6258061002	Štitnik	RBC2100	
Pribor za profilisanj e i poravnaj	 6258064001	Štitnik	DBC260U	
Pribor za višenam enski alat	 6278011002	Štitnik	RBC3101	
Pribor za testere	 6358008004	Štitnik	RBC420E	
Pribor za pneumat ske alate	 6418027000	Poklopac sekača	DBC260U, EBH341R, RBC250, RBC2500, RBC420E, EM4250	
Pribor za fenove za vrući vazduh	 DA00000525	Štitnik	EM2500U/L, EM2600U/L	
Pribor za usisivanj e				
Pribor za alate za rad na otvoreno				
Pribor za držače alata i zaštitna				
Koferi i torbe				
Ručni alati				
Ostalo				
Pribor za mješanje				

[Nastavak...](#)

# Pribor za alate za rad na otvorenom

Model	Naziv	Za model	Cena sa PDV-om	
DA00000526	Štitnik	EM2500U		
XNR0000501	Štitnik	EBH341R		

## Kaiševi za rame

Model	Naziv	Za model	Cena sa PDV-om	
122906-3	Naramenica	DUR369A, EBH252U, EBH253U, EBH341U, EM2650UH, EM2651UH, EM4350UH, RBC411U, RBC412U, RBC413U, RBC414U, UR002G, UR006G, UR007G		
122907-1	Kaiš za rame	BBC, BC, EBH, EM		
122A37-4	Pojas za rame	UR006G, UR007G, UR012G		
125516-5	Naramenica	DUN500W, DUN501W, DUR181, DUR184L, DUR187L, DUR188L, DUR189, DUR190L, DUR191L, DUR192L, DUR194, DUR364L, DUR368A, DUR368L, UR100D, UR180D, DUR366L, DUX60		
125520-4	Kaiš za nošenje o rame	DUR191, DUR191, DUR187U, DUR188U, DUR368A/L, DUR369L, RBC413U, RBC414U		
126012-6	Naramenica	RBC2500, RBC2510, RBC3110		
127508-0	Naramenica	DUX18, DUR192L, DUR193, DUR194, UR002G, UR003G, UX01G		
191K37-5	Remen za rame	DUA301		
197243-4	Naramenica	UR101C, UR201C		
6417015004	Naramenica	RBC420E		

Nastavak...

Akumulat  
ori i  
punjači

Pribor za  
akumulat  
orske  
alate

Akumulat  
orske  
lampe i  
pribor

Pribor za  
laserske  
merace

Pribor za  
rušenje i  
udarno  
bušenje

Pribor za  
bušenje

Krunaste  
testere

Pribor za  
pritezanje

Pribor za  
sečenje i  
brusenje

Pribor za  
brusenje i  
poliranje

Pribor za  
profilisanje  
i  
poravnava

Pribor za  
višenam  
enski alati

Pribor za  
testere

Pribor za  
pneumat  
ske alate

Pribor za  
fenove  
za vrući  
vazduh

Pribor za  
usisvanje

Pribor za  
alate za  
rad na  
otvoreno

Pribor za  
držače  
alata i  
zaštitna



Koferi i  
torbe

Ručni  
alati



Ostalo

Pribor za  
mješanje

# Pribor za alate za rad na otvorenom

	Model	Naziv	Za model	Cena sa PDV-om
	DA00000037	Kaiš za rame	UR3000	
	XNR0000474	Naramenica	BBC, BC, EBH, EM	

## Ostali pribor

	Model	Naziv	Za model	Cena sa PDV-om
	140400-3	Kuka	EBH252U	
	168578-0	Kuka	EBH341U, EBH252U	

## Kosilice za travu



## Noževi

Model	Ukupna dužina (mm)	Za model	Cena sa PDV-om
671002550	330	ELM3311, ELM3310	
GB00000042	330	DLM330	
YA00000745	330	ELM3320	
671002549	370	ELM3711	
YA00000746	370	ELM3720	
191D41-2	380	DLM382	
671001427	410	ELM4110	
671001433	410	PLM4120N	
YA00000738	410	ELM4121	
YA00000747	410	ELM4120	
191D43-8	430	DLM432	
197760-4	430	DLM431, DLM432	
191D51-9	460	DLM462, DLM465	
191Y63-8	460	DLM462	
199367-2	460	DLM462, DLM460	
671014610	460	PLM4610, PLM4611, PLM4618, PLM4621, PLM4622, PLM4627, PLM4630, PLM4631, PLM4632	

[Nastavak...](#)

# Pribor za alate za rad na otvorenom

311

Model	Ukupna dužina (mm)	Za model	Cena sa PDV-om
671146102	460	ELM4610, ELM4611, ELM4612, ELM4613	
YA00000741	460	ELM4620, ELM4621	
191V97-3	480	DLM480, DLM481, LM001J	
191Y64-6	480	DLM480, DLM481, LM001J	
671003181	480	PLM4817, PLM4818, PLM4819	
671002552	510	PLM5113, PLM5130, PLM5102	
DA00000944	510	PLM5120, PLM5121	
191V96-5	530	DLM538, DLM539, LM002J	
191W87-2	530	DLM533, DLM532, DLM530, LM001C	
191Y65-4	530	DLM538, DLM539, LM002J	
671002532	560	PLM5600N	



## Disk ploča sa noževima

Noževi su konstruisani tako da se sklapaju prilikom udarca u tvrd predmet čime se smanjuje opasnost od lomljenja vretena. Više noževa reže travu na sitnije delove što smanjuje mogućnost da se trava zaglavi u šasiji kosilice.

Model	Naziv	Ukupna dužina (mm)	Za model	Cena sa PDV-om
191D47-0	Rezervni noževi za 191D49-1	/	191D49-6	
191D48-8	Rezervni noževi za 191D50-1	/	191D50-1	
191D49-6	Ploča sa 4 noža za DLM46x	460	DLM462, DLM465	
191D50-1	Ploča sa 4 noža za DLM53x	530	DLM530, DLM532, DLM533, LM001C	



## Ploče za mulčanje

Model	Za model	Cena sa PDV-om
127515-3	DLM462	

Nastavak...



Akumulat  
ori i  
punjači

Pribor za  
akumulat  
orske  
alate

Akumulat  
orske  
lampe i  
pribor

Pribor za  
laserske  
merace

Pribor za  
rušenje i  
udarno  
bušenje

Pribor za  
bušenje

Krunaste  
testere

Pribor za  
pritezani  
e

Pribor za  
sečenje i  
brusenje

Pribor za  
brusenje  
i  
poliranje

Pribor za  
profilisanj  
e i  
poravnav

Pribor za  
višenam  
enski alat

Pribor za  
testere

Pribor za  
pneumat  
ske alate

Pribor za  
fenove  
za vrući  
vazduh

Pribor za  
usisivanj  
e

Pribor za  
alate za  
rad na  
otvoreno

Pribor za  
držače  
alata i  
zaštitna

Koferi i  
torbe

Ručni  
alati

Ostalo

Pribor za  
mješanje

# Pribor za alate za rad na otvorenom

Model	Za model	Cena sa PDV-om
127516-1	DLM532, DLM530, LM001C	
127550-1	DLM533	
412273-7	DLM432, DLM382	
413945-7	DLM538, DLM539, LM002J	
413946-5	DLM480, DLM481, LM001J	
671315001	PLM5600N	
671326001	PLM4618, PLM4628N, PLM4627N	
671469001	ELM4611, ELM4610, PLM5102, PLM4612, PLM4611PLM4610, PLM4110	
671509001	PLM5113, PLM5130	
671660001	DLM460	
671936001	PLM4632N, PLM4631N, PLM4630N, ELM4612, ELM4613, PLM5130N	
GB00000067	DLM330	

## Vertikulatori

### Vratila

	Model	Naziv	Za model	Cena sa PDV-om
	652024718	Vratilo sa noževima	UV3200	
	652024719	Vratilo sa grabuljama	UV3200	
	652024746	Vratilo sa noževima	UV3600	
	652024749	Vratilo sa noževima	UV3600	
	652024750	Vratilo sa grabuljama	UV3600	



## Duvalice

### Pribor za duvaljke

Model	Naziv	Za model	Cena sa PDV-om	
122321-1	Kesa za prašinu	UB1103		
123241-2	Kesa za prašinu	DUB182, DUB183, UB1102, UB1103, UB100D, UB101D		
123245-4	Duga mlaznica	DUB185, UB1103, UB100D, UB101D		
123246-2	Mlaznica duga 43cm	UB1103, UB100D, UB101D		
132025-7	Mlaznica	BVC340, BVC350, DUB182, DVC340, DVC350, UB1101, UB120D, UB181D		
134182-7	Mlaznica	DVC340, DVC350, UB1103		
166094-6	Traka	DUB362, DVC350, BVC340, BVC350, DUB184, DGP180, UB001G		
166095-4	Kajiš za rame	DUB183, DUB361, DUB362, UB360		
168746-5	Mlaznica	BBX7600		
191750-9	Fleksibilna creva komplet 0,95	DUB182, DUB183		
191B03-8	Mlaznica	DUB184, DUB362, DUB363, UB001C, UB001G		
191B21-6	Adapter cev sa 80-72	DUB184		
191C15-7	Adapter B	UB400MP, UB401MP		
191E19-1	Komplet za usisivač	DUB363		
191G09-6	Dugačka savijena mlaznica	DUB142, DUB143, DUB182, DUB183, DUB185, DUB186, UB1102, UB1103, UB100D, UB101D		
191J13-3	Adapter 71	DUB362		

Nastavak...

Akumulat  
ori i  
punjači

Pribor za  
akumulat  
orske  
alate

Akumulat  
orske  
lampe i  
pribor

Pribor za  
laserske  
merace

Pribor za  
rušenje i  
udarno  
bušenje

Pribor za  
bušenje

Krunaste  
testere

Pribor za  
pritazani  
e

Pribor za  
sečenje i  
brusjenje

Pribor za  
brusjenje  
i  
poliranje

Pribor za  
profilisanj  
e i  
poravnaj

Pribor za  
višenam  
enski alat

Pribor za  
testere

Pribor za  
pneumat  
ske alate

Pribor za  
fenove  
za vrući  
vazduh

Pribor za  
usisivanj  
e

Pribor za  
alate za  
rad na  
otvoreno

Pribor za  
držače  
alata i  
zaštitna















Koferi i  
torbe

Ručni  
alati

Ostalo

Pribor za  
mješanje

# Pribor za alate za rad na otvorenom

	Model	Naziv	Za model	Cena sa PDV-om
Akumulat ori i punjači				
Pribor za akumulat orske alate	 191J48-4	Pojas za rame	UB001C, UB001G	
Akumulat orske lampe i pribor	 191L13-5	Adapter 80-72	DUB184	
Pribor za laserske merace	 191L96-5	Adapter 85-72	UB001C, UB001G	
Pribor za rušenje i udarno bušenje	 191M30-1	Mlaznica za prašinu	DUB142, DUB143, DUB182, DUB183, DUB185, DUB186, UB1102, UB1103, UB100D, UB101D	
Pribor za bušenje	 191M32-7	Nastavak za razpihovanje	DUB142, DUB143, DUB182, DUB183, DUB185, DUB186, UB1102, UB1103, UB100D, UB101D	
Krunaste testere	 191M34-3	Fleksibilno crevo	DUB142, DUB143, DUB182, DUB183, DUB185, DUB186, UB1102, UB1103, UB100D, UB101D	
Pribor za rušenje i udarno bušenje	 191P97-7	Mlaznica 80	UB001C, UB001G	
Pribor za brušenje i poliranje	 196334-8	Antistatički komplet	BBX7600	
Pribor za profilisanje i poravnavanje	 196643-5	Fleksibilno crevo 0,95	UB1102, UB1103, UB100D, UB101D	
Pribor za višenamenski alat	 196729-5	Savitljiva duga cev	UB1103	
Pribor za testere	 196956-4	Kaiš za rame	EB5300TH, EB7650TH, EB7660TH	
Pribor za pneumatske alate	 197235-3	Komplet za usisivač	BHX2501	
Pribor za fenove za vrući vazduh	 197888-8	Nastavak	DUB362, DUB363, UB001C, UB001G	
Pribor za usisivanje	 197889-6	Ravna mlaznica	DUB362, DUB363, UB001C, UB001G	
Pribor za držače alata i zaštitna	 451752-0	Duga cev	PM7651H, BX2501	
Koferi i torbe				
Ručni alati				
Ostalo				
Pribor za mješanje				

[Nastavak...](#)

# Pribor za alate za rad na otvorenom

315

Model	Naziv	Za model	Cena sa PDV-om	
452123-4	Duga mlaznica	DUB183, DUB361, UB360		
454895-7	Duga cev 90	EB5300TH, EB7650TH, EB7660TH		
454896-5	Mlaznica, 90-60	EB5300TH, EB7650TH, EB7660TH		
454916-5	Ravna mlaznica 90	EB5300TH, EB7650TH, EB7660TH		
455128-3	Mlaznica, 90-70	EB5300TH, EB7650TH, EB7660TH		
455631-4	Mlaznica, 20 cm	PM7651H		
455632-2	Završetak cevi	PM7651H		
455634-8	Ravna mlaznica, 45 cm	PM7651H		
455915-0	Duga mlaznica	DUB362		
456957-7	Mlaznica, 45 cm	DUB184, DUB362		
456958-5	Ravna mlaznica, 45 cm	DUB184, DUB362		
6609512200	Završetak cevi	BHX2501		
6679500000	Savitljiva cev	BBX7600		
6679501801	Prava cev	BBX7600		
GT00000002	Komplet za usisivač	UB0801V		
GT34103808	Ravna mlaznica 90	UB0800		

- Akumulat orni i punjači
- Pribor za akumulat orske alate
- Akumulat orske lampe i pribor
- Pribor za laserske merace
- Pribor za rušenje i udarno bušenje
- Pribor za bušenje
- Krunaste testere
- Pribor za pritezanje
- Pribor za sečenje i bušenje
- Pribor za bušenje i poliranje
- Pribor za profilisanje i poravnavanje
- Pribor za višenamenski alat
- Pribor za testere
- Pribor za pneumaticke alate
- Pribor za fenove za vrući vazduh
- Pribor za usisivanje
- Pribor za alate za rad na otvoreno
- Pribor za držače alata i zaštitna
- Koferi i torbe
- Ručni alati
- Ostalo
- Pribor za mješanje

## Čistači pritiskom









## Pištolji za visoki pritisak

Model	Za model	Cena sa PDV-om
40797	HW101	
3320152	HW102, HW111, HW112	
40718	HW110, HW130	
41323	HW120	
197842-2	HW1200, HW1300, DHW080	
40728	HW131	
3640920	HW132	



## Creva i produžeci za visoki pritisak

	Model	Naziv	Dužina creva (m)	Za model	Cena sa PDV-om
	126766-5	Crevo visokog pritiska 5m	5	DHW080	
	3640630	Crevo za visoki pritisak	5	HW102	
	41179	Nastavak za crevo za visoki pritisak	5	HW102	
	40807	Crevo za visoki pritisak	5,5	HW110	
	3640660	Crevo za visoki pritisak	5,5	HW111, HW112	
	41181	Nastavak za crevo za visoki pritisak	8	HW111, HW112, HW132	

[Nastavak...](#)

# Pribor za alate za rad na otvorenom

317

Model	Naziv	Dužina creva (m)	Za model	Cena sa PDV-om	
3163270	Crevo za visoki pritisak	8	HW120		
40106	Nastavak za crevo za visoki pritisak	15	HW120		
123784-4	Crevo visokog pritiska	10	HW1200, DHW080		
197845-6	Crevo za visoki pritisak	5	HW1200, HW1300, DHW080		
197847-2	Crevo za visoki pritisak	8	HW1200, HW1300, DHW080		
197850-3	Crevo za visoki pritisak	10	HW1200, HW1300, DHW080		
2620551	Crevo za visoki pritisak	8	HW130		
40808	Crevo za visoki pritisak	7,5	HW130		
40809	Crevo za visoki pritisak	15	HW131		
3640960	Crevo za visoki pritisak	8	HW132		

## Produžeci za koplje

Model	Naziv	Za model	Cena sa PDV-om	
40057	Nastavak za četku	HW101, HW102, HW110, HW111, HW112, HW130, HW131, HW132, HW140, HW151		
3320130	Nastavak za koplje	HW102, HW111, HW112		
40720	Nastavak za koplje	HW110, HW130		
3718	Nastavak za koplje	HW120		

Nastavak...

Akumulat  
ori i  
punjači

Pribor za  
akumulat  
orske  
alate

Akumulat  
orske  
lampe i  
pribor

Pribor za  
laserske  
merace

Pribor za  
rušenje i  
udarno  
bušenje

Pribor za  
bušenje

Krunaste  
testere

Pribor za  
pritezanj  
e

Pribor za  
sečenje i  
brusenje

Pribor za  
brusenje  
i  
poliranje

Pribor za  
profilisanj  
e i  
poravnaj

Pribor za  
višenam  
enski alat

Pribor za  
testere

Pribor za  
pneumat  
ske alate

Pribor za  
fenove  
za vrući  
vazduh

Pribor za  
usisivanj  
e

Pribor za  
alate za  
rad na  
otvoreno

Pribor za  
držače  
alata i  
zaštitna

Koferi i  
torbe

Ručni  
alati





Ostalo

Pribor za  
mješanje





# Pribor za alate za rad na otvorenom

	Model	Naziv	Za model	Cena sa PDV-om
	197867-6	Okretni rukavac za crevo	HW1200, HW1300, DHW080	
	197870-7	Nastavak za koplje (90 cm, 130 cm, 170 cm)	HW1200, HW1300, DHW080	
	40029	Koplje i glava koplja	HW140	

## Četke

	Model	Naziv	Za model	Cena sa PDV-om
	41185	Četka za pranje	HW101, HW110, HW130, HW102, HW140, HW151	
	41187	Rotaciona četka	HW102, HW111, HW112, HW132, HW140, HW151	
	197828-6	Četka za pranje	HW1200, HW1300, DHW080	
	197831-7	Rotirajuća četka za pranje	HW1200, HW1300, DHW080	
	197864-2	Čistač za pod	HW1200, HW1300, DHW080	

















## Mlaznice i pribor

	Model	Naziv	Za model	Cena sa PDV-om
	3541	Alat za čišćenje	/	
	127104-4	Spremnik za vodu	DHW080	
	191U86-2	Variabilna mlaznica	DHW080, HW1200, HW1300	
	191U88-8	Set mlaznice i produžetak	DHW080, HW1200, HW1300	
	199486-4	Naramenica za nošenje	DVC750, DHW080	

[Nastavak...](#)

# Pribor za alate za rad na otvorenom













319

Model	Naziv	Za model	Cena sa PDV-om	
40798	Promenljiva mlaznica sa kopljem	HW101		
40800	Mlaznica sa rezervoarom za deterdžent	HW101		
3640090	Mlaznica sa rezervoarom za deterdžent	HW102		
3640640	Promenljiva mlaznica	HW102		
41169	Turbo koplje	HW102, HW111, HW112		
40794	Mlaznica - turbo	HW110		
40795	Ispod podna mlaznica	HW110		
40796	Promenljiva mlaznica	HW110		
40810	Mlaznica sa rezervoarom za deterdžent	HW110, HW130		
3640650	Promenljiva mlaznica	HW111, HW112		
3640670	Mlaznica za nanošenje deterdženta	HW111, HW112, HW132		
3195	Promenljiva mlaznica	HW120		
197822-8	Koplje i glava koplja	HW1200, HW1300, DHW080		
197824-4	Nastavak za koplje	HW1200, HW1300, DHW080		
197853-7	Mlaznica	HW1200, HW1300, DHW080		
197876-5	Promenljiva mlaznica	HW1200, HW1300, DHW080		
197879-9	Alat za čišćenje	HW1200, HW1300, DHW080		

Nastavak...

- Akumulatori i punjači
- Pribor za akumulatorske alate
- Akumulatorske lampe i pribor
- Pribor za laserske merace
- Pribor za rušenje i udarno bušenje
- Pribor za bušenje
- Krunaste testere
- Pribor za pritezanje
- Pribor za sečenje i brusenje
- Pribor za brusenje i poliranje
- Pribor za profilisanje i poravnanje
- Pribor za višenamenski alat
- Pribor za testere
- Pribor za pneumatske alate
- Pribor za fenove za vrući vazduh
- Pribor za usisivanje
- Pribor za alate za rad na otvorenom**
- Pribor za držače alata i zaštitna
- Koferi i torbe
- Ručni alati
- Ostalo
- Pribor za mješanje

# Pribor za alate za rad na otvorenom

	Model	Naziv	Za model	Cena sa PDV-om
	197886-2	Mlaznica sa rezervoarom za deterdžent	HW1200, HW1300, DHW080	
	198909-9	Ispod podna mlaznica	HW1200, HW1300, DHW080	
	40719	Promenljiva mlaznica	HW130	
	40721	Mlaznica - turbo	HW130	
	40722	Ispod podna mlaznica	HW130	
	40729	Promenljiva mlaznica sa kopljem	HW131	
	40730	Mlaznica - turbo	HW131	
	3640930	Promenljiva mlaznica sa kopljem	HW132	
	41171	Turbo koplje	HW132	
	40246	Promenljiva mlaznica sa kopljem	HW140	
	41173	Turbo koplje	HW140/HW151	
	40551	Promenljiva mlaznica sa kopljem	HW151	

Akumulat ori i punjači
Pribor za akumulat orske alate
Akumulat orske lampe i pribor
Pribor za laserske merace
Pribor za rušenje i udarno bušenje
Pribor za bušenje
Krunaste testere
Pribor za pritezani e
Pribor za sečenje i brusenje
Pribor za brusenje i poliranje
Pribor za profilisanj e i poravnaj
Pribor za višenam enski alat
Pribor za testere
Pribor za pneumat ske alate
Pribor za fenove za vrući vazduh
Pribor za usisivanj e
Pribor za alate za rad na otvoreno
Pribor za držače alata i zaštitna
Koferi i torbe
Ručni alati
Ostalo
Pribor za mješanje



# Pribor za alate za rad na otvorenom

321

## Čistači podova



Model	Naziv	Za model	Cena sa PDV-om
41175	Čistač za pod	HW102, HW111, HW112, HW132	
41849	Čistač za pod sa rezervoarom za deterdžent, Twister (22x1,5 adaptor)	HW140, HW151	



## Cevi za čišćenje odvoda



Model	Naziv	Dužina creva (m)	Za model	Cena sa PDV-om
197837-5	Crevo za ispuštanje	10	HW1200, HW1300, DHW080	
41165	Crevo za ispuštanje	10	HW101, HW102, HW110, HW111, HW112, HW130, HW131, HW132, HW140, HW151	
197840-6	Crevo za ispuštanje	15	HW1200, HW1300, DHW080	
41167	Crevo za ispuštanje	16	HW101, HW102, HW110, HW111, HW112, HW130, HW132, HW140, HW151	

## Priključci i filteri

Model	Naziv	Za model	Cena sa PDV-om
197873-1	Komplet usisnog creva	HW1200, HW1300, DHW080	
197881-2	Priključak za vodu	HW1200, HW1300, DHW080	
197883-8	Spojnica za spajanje jednim potezom	HW1200, HW1300, DHW080	



[Nastavak...](#)

Akumulat  
ori i  
punjači

Pribor za  
akumulat  
orske  
alate

Akumulat  
orske  
lampe i  
pribor

Pribor za  
laserske  
merace

Pribor za  
rušenje i  
udarno  
bušenje

Pribor za  
bušenje

Krunaste  
testere

Pribor za  
pritezanje

Pribor za  
sečenje i  
brusjenje

Pribor za  
brusjenje  
i  
poliranje

Pribor za  
profilisanje  
i  
poravnavanje

Pribor za  
višenam  
enski alat

Pribor za  
testere

Pribor za  
pneumat  
ske alate

Pribor za  
fenove  
za vrući  
vazduh

Pribor za  
usisivanje

Pribor za  
alate za  
rad na  
otvoreno

Pribor za  
držače  
alata i  
zaštitna







Koferi i  
torbe

Ručni  
alati

Ostalo



Pribor za  
mješanje

# Pribor za alate za rad na otvorenom

	Model	Naziv	Za model	Cena sa PDV-om
	3082130	Priključak za vodu	HW102	
	3440720	Usisno sito - filter	HW111	
	3640680	Providno crevo 0,8 m	HW112	
	40725	Spojka za crevo	HW	
	41161	Filter za ulaznu vodu	HW101, HW102, HW110, HW111, HW112, HW130, HW131, HW132, HW140, HW151	
	50713	Filteri za ulaznu vodu	HW120	



## Posude za Deterdžente

	Model	Naziv	Za model	Cena sa PDV-om
	3640380	Posuda za deterdžent	HW132	
	3640390	Poklopac za posudu za deterdžent	HW132	

## Motorni sekači

### Listovi

Model	Naziv	Prečnik dijamantskog lista Ø (mm)	Prečnik nasadnog otvora Ø (mm)	Visina segmenta (mm)	Najveći broj obrtaja (min <sup>-1</sup> )	Opis	Jedinica (kom/kompl)	Cena sa PDV-om	
B-13269	Dijamantski glatki list Comet	300	20	10	6.360	3DDG, Asphalt			
B-13459	Dijamantski disk Quasar	300	20	12	6.400	3DDG, tihi rad			
B-13546	Dijamantski disk Comet Rapide	300	20	10	6.400	3DDG, otvori za hlađenje			
B-17588	Dijamantski disk Quasar	300	25,4	12	6.400	3DDG, tihi rad			
B-17619	Dijamantski disk Comet Rapide	300	25,4	10	6.400	3DDG, otvori za hlađenje			
B-54031	Dijamantski disk Nebula	300	20	10		Laserski zavareni segmenti			
B-54047	Dijamantski disk Nebula	300	20	10		Laserski zavareni segmenti			
B-13275	Dijamantski glatki list Comet	350	25,4/20	10	5.500	3DDG, Asphalt			
B-13465	Dijamantski disk Quasar	350	25,4/20	12	5.500	3DDG, tihi rad			
B-13552	Dijamantski disk Comet Rapide	350	25,4/20	10	5.550	3DDG, otvori za hlađenje			
B-54053	Dijamantski disk Nebula	350	25,4	10		Laserski zavareni segmenti			
E-12996	Dijamantna rezna ploča za beton	355	25,4	8	5.500	segmentni rub	1		

Nastavak...

Akumulatori i punjači

Pribor za akumulatorske alate

Akumulatori lampe i pribor

Pribor za laserske merace

Pribor za rušenje i udarno bušenje

Pribor za bušenje

Krunaste testere

Pribor za pritezanje

Pribor za sečenje i brušenje

Pribor za brušenje i poliranje

Pribor za profilisanje i poravnanje

Pribor za višenamenski alat

Pribor za testere

Pribor za pneumatske alate

Pribor za fenove za vrući vazduh

Pribor za usisivanje

Pribor za alate za rad na otvorenom

Pribor za držače alata i zaštitna





Koferi i torbe

Ručni alati

Ostalo

Pribor za mješanje

# Pribor za alate za rad na otvorenom

	Model	Naziv	Prečnik dijamantskog lista Ø (mm)	Prečnik nasadnog otvora Ø (mm)	Visina segmenta (mm)	Najveći broj obrtaja (min <sup>-1</sup> )	Opis	Jedinica (kom/kompl)	Cena sa PDV-om
	B-13471	Dijamantski disk Quasar	400	25,4/20	12	4.770	3DDG, tihi rad		
	B-13568	Dijamantski disk Comet Rapide	400	25,4/20	10	4.800	3DDG, otvori za hlađenje		
	B-42905	Dijamantski disk Comet Asphalt	400	25,4/20	10	4.800	3DDG, Asphalt		
	B-54069	Dijamantski disk Nebula	400	25,4	10		Laserski zavareni segmenti		



## Ostali pribor

	Model	Naziv	Za model	Cena sa PDV-om
	424789-0	Filter	EK6100, EK6101	
	424700-2	Predfilter	EK7300, EK7301, EK8100	
	424701-0	Filter	EK7300, EK7301, EK8100	
	957802600	Cilindrični rezervoar za vodu pod pritiskom, 3-5 bar, 10 L	EK7301WS, CE001G	
	394369610	Kolica	EK7650H, EK7651H	
	195599-9	predfilter za mokro 5kom, papirni filter za suvo 1kom	EK7651H	
	197980-0	Kolica za vođenje sa vodenom pumpom za motorne sekače	EK7651H	
	198172-4	Predfilter	EK7651H	

Nastavak...











# Pribor za alate za rad na otvorenom

325

Model	Naziv	Za model	Cena sa PDV-om	
442165-6	Filter	EK7651H		
394365102	Priključni komplet za vodu	EK8100		

## Prskalice

### Pribor

Model	Naziv	Za model	Cena sa PDV-om	
6958028000	Mlaznica za raspršivanje	BVF104, EVH2000		
6958029000	Dvojna mlaznica sa Y rasporedom	BVF104, EVH2000		
6959505801	Cev za raspršivanje	BVF104RF		
6909511104	Držač cevi	BVF104RF, EVH2000		
6939025000	Kompaktna mlaznica	BVF104RF, EVH2000		
6958011000	Mlaznica za herbicide	BVF104RF, EVH2000		
6958025000	Široko ugaona dvojna mlaznica sa Y rasporedom	BVF104RF, EVH2000		
6909500100	Tristruko koncentrična mlaznica	EVH2000		
6919500000	Četistruko koncentrična mlaznica	EVH2000		
6939024000	Mlaznica za mlaz	EVH2000		
6939028000	Super mlaznica za mlaz	EVH2000		

Nastavak...

Akumulat  
ori i  
punjači

Pribor za  
akumulat  
orske  
alate

Akumulat  
orske  
lampe i  
pribor

Pribor za  
laserske  
merace

Pribor za  
rušenje i  
udarno  
bušenje

Pribor za  
bušenje

Krunaste  
testere

Pribor za  
pritezanje

Pribor za  
sečenje i  
brusjenje

Pribor za  
brusjenje  
i  
poliranje

Pribor za  
profilisanje  
i  
poravnanje

Pribor za  
višenam  
enski alati

Pribor za  
testere

Pribor za  
pneumat  
ske alate

Pribor za  
fenove  
za vrući  
vazduh

Pribor za  
usisivanje

Pribor za  
alate za  
rad na  
otvoreno

Pribor za  
držače  
alata i  
zaštitna

Koferi i  
torbe

Ručni  
alati

Ostalo

Pribor za  
mješanje

# Pribor za alate za rad na otvorenom

	Model	Naziv	Za model	Cena sa PDV-om
	6949001000	Mlaznica sa 2 glave	EVH2000	
	6958018000	Dvojna mlaznica u U-raspored	EVH2000	
	6909511501	Mlaznica	EVH2000, EF1551RH	
	PR00000128	Remen za rame	US053D, DUS054	
	PR00000142	Mlaznica	US053D, DUS054	
	PR00000144	Kuka	US053D, DUS054	
	PR00000145	Cev	US053D, DUS054	
	PR00000147	Filter sa zaptivkom	US053D, DUS054	

Akumulat ori i punjači
Pribor za akumulat orske alate
Akumulat orske lampe i pribor
Pribor za laserske merace
Pribor za rušenje i udarno bušenje
Pribor za bušenje
Krunaste testere
Pribor za pritezani e
Pribor za sečenje i brusenje
Pribor za brusenje i poliranje
Pribor za profilisanj e i poravnav
Pribor za višenam enski alat
Pribor za testere
Pribor za pneumat ske alate
Pribor za fenove za vrući vazduh
Pribor za usisivanj e
<b>Pribor za alate za rad na otvoreno</b>
Pribor za držače alata i zaštitna
Koferi i torbe
Ručni alati
Ostalo
Pribor za mješanje

# BUŠILICE ZA ZEMLJU



Pogodno za bušenje u peskovitom tlu sa travnatim korenom i šljunkom. Koristi se za prihranjivanje, sadnju drveća i za bušenje pripremljenih rupa za zabijanje različitih vrsta kočica.

## BURGIJE ZA BUŠENJE

Prečnik	Ukupna dužina	Radna dužina	Model
ø50 mm	800 mm	550 mm	E-13611
ø60 mm			E-13627
ø80 mm			E-13633
ø100 mm			E-07294
ø150 mm			E-07303
ø200 mm			E-07319

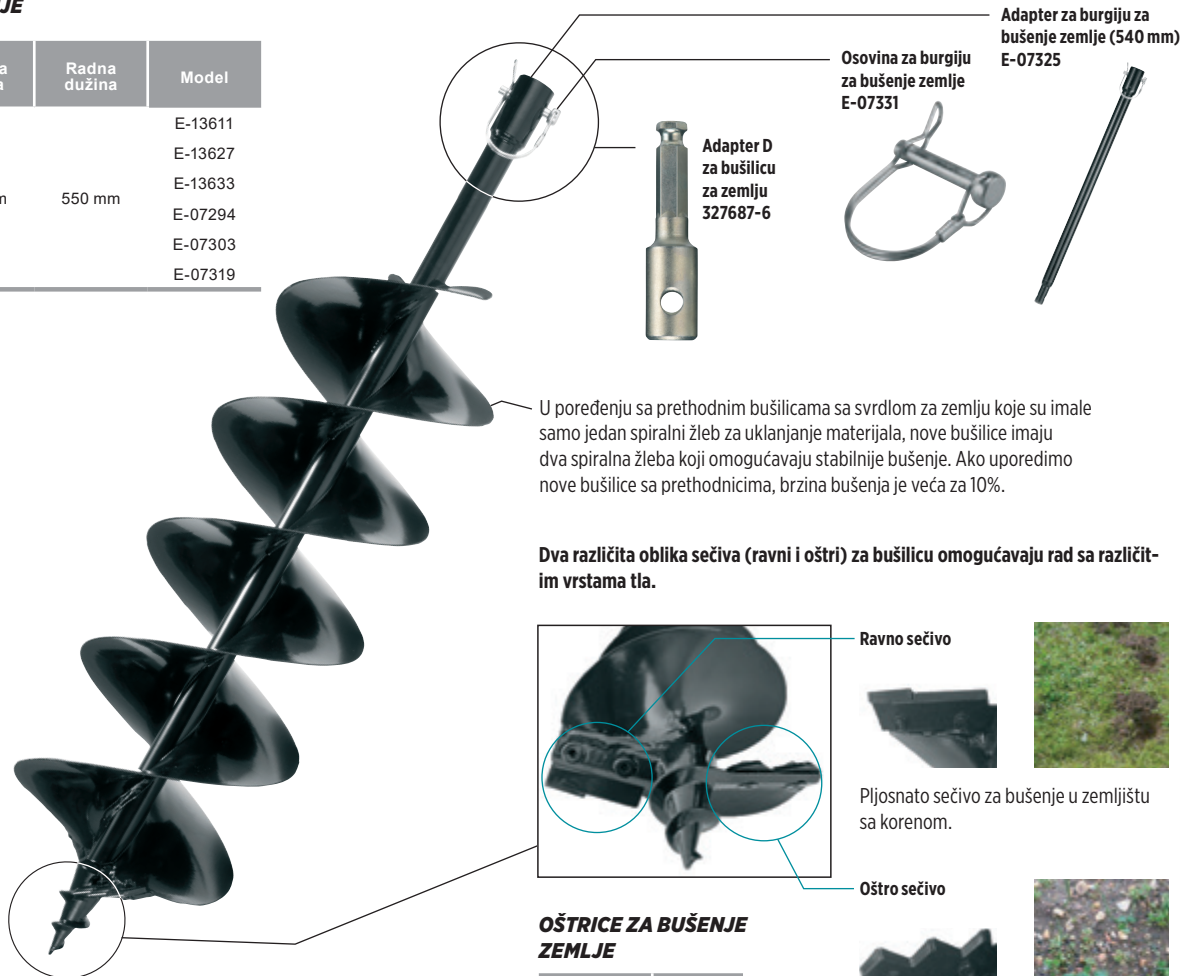

Adapter za burgiju za bušenje zemlje (540 mm) E-07325

Osovina za burgiju za bušenje zemlje E-07331

Adapter D za bušilicu za zemlju 327687-6

U poređenju sa prethodnim bušilicama sa svrdlom za zemlju koje su imale samo jedan spiralni žleb za uklanjanje materijala, nove bušilice imaju dva spiralna žleba koji omogućavaju stabilnije bušenje. Ako uporedimo nove bušilice sa prethodnicima, brzina bušenja je veća za 10%.

Dva različita oblika sečiva (ravni i oštri) za bušilicu omogućavaju rad sa različitim vrstama tla.

Ravno sečivo

Pljosnato sečivo za bušenje u zemljištu sa korenom.

Oštro sečivo

Oštra oštrica za bušenje u zemljištu sa šljunkom.

## OŠTRICE ZA BUŠENJE ZEMLJE

Za prečnik	Model
50 mm	E-13649
60 mm	E-13655
80 mm	E-13661
100 mm	E-07630
150 mm	E-07646
200 mm	E-07652

## DRŽAČ BUŠILICE ZA ZEMLJU

Model	Za model
191P11-3	DG001G, DDG460

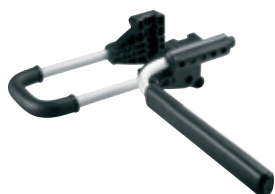

\*Bušilica prečnika 200 mm je pogodna samo za bušenje u peskovitom tlu.

# PRIBOR ZA DRŽAČE ALATA I ZAŠTITNA OPREMA





## Držači alata i pribor

### Držači alata i pribor

Model	Naziv	Za model	Cena sa PDV-om	
127778-1	Kuka	DDA450		
191C05-0	Kuka	JR3051		
191F45-6	Kuka	HR3011FC, HR3012FC, HR3001C		
191G64-8	Kuka	DPB183,DPB184		
191K57-9	Komplet za kačenje alata	DTD157		
191W90-3	Kuka	HR007G		
197043-2	Kuka za nošenje odvijača	DTD134, DTD137, DTD146, DTD148, DTD153, DTD154, DTD155, DTD170, DTS130, DTS131, DTS141, DTW152		
197224-8	Široka kuka	DCS551, DHR171, DSD180, HR166D, SD100D		
197941-0	Naramenica sa kukom za nošenje odvijača	DTW190		
199231-7	Viseća kuka za testere	DHS660, DHS661		
199296-9	Kuka	DCS553		
199386-8	Kuka	DHS780, DHS781, DHS782, DHS783		

[Nastavak...](#)

Akumulat  
ori i  
punjači

Pribor za  
akumulat  
orske  
alate

Akumulat  
orske  
lampe i  
pribor

Pribor za  
laserske  
merace

Pribor za  
rušenje i  
udarno  
bušenje

Pribor za  
bušenje

Krunaste  
testere

Pribor za  
pritezani  
e

Pribor za  
sečenje i  
brusenje

Pribor za  
brusenje  
i  
poliranje

Pribor za  
profilisanj  
e i  
poravnav

Pribor za  
višenam  
enski alat

Pribor za  
testere

Pribor za  
pneumat  
ske alate

Pribor za  
fenove  
za vrući  
vazduh

Pribor za  
usisivanj  
e

Pribor za  
alate za  
rad na  
otvoreno

Pribor za  
držače  
alata i  
zaštitna



Koferi i  
torbe

Ručni  
alati

Ostalo

Pribor za  
mješanje

# Pribor za držače alata i zaštitna oprema

	Model	Naziv	Za model	Cena sa PDV-om
	346317-0	Kuka	/	
	346449-3	Kuka	/	
	346949-3	Kuka	DTW1001, DTW1002, TW001G, TW007G	

## Bezbednosna oprema

### Zaštitne naočare

	Model	Naziv	Cena sa PDV-om
	192219-6	Zaštitne naočare	
	AL00000147	Zaštitne naočare	

# KOFERI I TORBE



## KOFERI

► 4 različite dimenzije kofera za odlaganje alata i pribora

► Koferi koji se mogu slagati jedan nadrugim za lakši transport i uštedu prostora

**821549-5** Makpac 1  
395×295×105 mm

**821550-0** Makpac 2  
395×295×155 mm

**821551-8** Makpac 3  
395×295×215 mm

**821552-6** Makpac 4  
395×295×315 mm

**453974-8** Plastična stega



## KOFERI SA FIOKAMA

► Moguće kombinovati sa ostalim kutijama iz sistema Makpac

**P-84311** Makpac 3  
395×295×215 mm



**P-84327** Makpac 3  
395×295×215 mm



**P-84333** Makpac 3  
395×295×215 mm



**P-84349** Makpac 4  
395×295×315 mm



## MAKPAC ORGANIZATORI

► Moguće pomeranje posuda za prilagođeno uređenje

► Sa providnim poklopcem

► Sa bočnim ručkama za lak transport



**191X80-2**  
Makpac organizator sa unutaršnjim posudicama  
395×295×110 mm

**191X84-4**  
Makpac organizator - prazan  
395×295×110 mm

③=①×4		③=①×4	④=①×6
①	①	②=①×2	⑤=①×9
①	①	②=①×2	
①	①	②=①×2	

## MAKPAC POSUDE ZA ORGANIZATORE

**191X92-5** Unutarnja posudica  
br. 1-5 za Makpac organizator

**191X93-3** Unutarnja posudica  
br. 1 za Makpac organizator  
50×50 mm

**191X94-1** Unutarnja posudica  
br. 2 za Makpac organizator  
100×50 mm

**191X95-9** Unutarnja posudica  
br. 3 za Makpac organizator  
100×100 mm

**191X96-7** Unutarnja posudica  
br. 4 za Makpac organizator  
150×100 mm

**191X97-5** Unutarnja posudica  
br. 5 za Makpac organizator  
150×150 mm

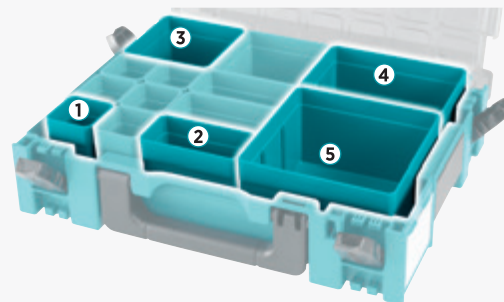

## KUTIJE

► Moguće kombinovati sa drugim kutijama za alat  
► Moguće je pričvrstiti na vrh Makpac kutija

**P-83836** 395×295×145 mm  
**P-83842** 395×295×250 mm

**P-84137** 395×295×165 mm



## FRIZIDER KOFERI

► Moguće kombinovati sa ostalim kutijama iz sistema Makpac

**198254-2** Makpac 3 - 11 l  
395×295×215 mm



**198253-4** Makpac 4 - 18 l  
395×295 × 315 mm



# Makpac sistem

## MAKPAC UNUTRAŠNJE OBLOGE ZA ALATE

► Preporučujemo vam da koristite sa Makpac 1 kućište jer njegova visina obezbeđuje dobro prijanjanje uložka i sprečava pomeranje uskladištenog pribora.



### P-84268

Podesivi uložak od pene za akumulatore sa umetkom od pene za Makpac poklopac

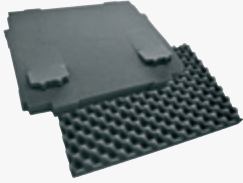

### P-83705

Podesivi umetak od pene

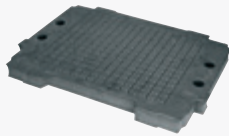

### 198978-0

Penasti umetak za Makpac poklopac

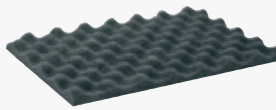

### P-83652

Unutrašnji umetak sa šarenim kutijama i umetkom od pene za Makpac poklopac

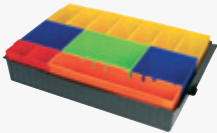

### P-83696

Unutrašnji umetak za pribor sa 9 podesivih pregrada



### P-83674

Unutrašnji umetak za pribor sa umetkom od pene za Makpac poklopac



### 839742-7

Unutrašnji umetak za 8x LXT akumulatore



### P-83668

Unutrašnji umetak za dodatnu opremu



### P-83680

Unutrašnji umetak za pribor sa 6 podesivih pregrada



## RAMENI POJAS

### 161576-3

Rameni pojas za Makpac kofer



## KOLICA ZA TRANSPORT KOFERA

### TR00000001

Kolica za Makpac sistem  
270-565x500x725-1125 mm

- Robusna aluminijumska konstrukcija
- Sklopiva transportna platforma
- Podesivi remen
- Maksimalna nosivost:  
125 kg (ravna površina)  
60 kg (kosa površina)



### P-83886

Kolica za Makpac sistem  
360x520x158 mm

- Dve pozicije zaključavanja kofera
- 360 ° rotirajući točkovi, dva sa kočnicom
- Maksimalna nosivost: 100 kg



## NOSAČ KOFERA ZA USISIVAČ

Za sigurnije kačenje Makpac kofera na Makita usisivač.

### W107418357

Za usisivač:  
VC4210



Za sigurnije kačenje Makpac kofera na Makita usisivač.

### 198599-8

Za usisivače:  
VC2211/  
VC3210/  
VC3211



- Akumulat
- ori i
- punjači
- Pribor za
- akumulat
- orske
- alate
- Akumulat
- orske
- lampe i
- pribor
- Pribor za
- laserske
- merace
- Pribor za
- rušenje i
- udarno
- bušenje
- Pribor za
- bušenje
- Krunaste
- testere
- Pribor za
- pritzanji
- e
- Pribor za
- sečenje i
- brusenje
- Pribor za
- brusenje
- i
- poliranje
- Pribor za
- profilisanj
- e i
- poravnav
- Pribor za
- višenam
- enski alat
- Pribor za
- testere
- Pribor za
- pneumat
- iske alate
- Pribor za
- fenove
- za vrući
- vazduh
- Pribor za
- usisivanj
- e
- Pribor za
- alate za
- rad na
- otvoreno
- Pribor za
- držače
- alata i
- zaštita
- Koferi i
- torbe
- Ručni
- alati
- Ostalo
- Pribor za
- mješanje

## Makpac unutrašnje obloge za alate

	MODEL ALATA	UNUTRAŠNJA POLICA	MAKPAC KOFER	MODEL ALATA	UNUTRAŠNJA POLICA	MAKPAC KOFER	MODEL ALATA	UNUTRAŠNJA POLICA	MAKPAC KOFER
Akumulat orni punjači	1911B	837878-6	3	DCS551	838269-4	3	DHP446	837916-4	2
Pribor za akumulat orske alate	3708F	837674-2	2	DDA340	838040-6	2	DHP448	837916-4	2
Akumulat orske lampe i pribor	3710	837674-2	2	DDA350	838040-6	2	DHP453	837916-4	2
Pribor za laserske merace	4100KB	839436-4	4	DDA351	838040-6	2	DHP456	837916-4	2
Pribor za rušenje i udarno bušenje	4329	837803-7	1	DDA341	838040-6	2	DHP458	837916-4	2
Pribor za bušenje	4350CT	837803-7	1	DDF+DTD	837864-7	3	DHP459	837916-4	2
Krunaste testere	4351CT	837803-7	1	DDF+DHR	838095-1	4	DHP470	837916-4	2
Pribor za pritezanje	5008MG	837657-2	4	DDF083	837670-0	2	DHP480	837916-4	2
Pribor za sečenje i brušenje	6413	838030-9	1	DDF343	837916-4	2	DHP481	837916-4	2
Pribor za brušenje i poliranje	6842	837876-0	1	DDF446	837916-4	2	DHP482	837916-4	2
Pribor za profilisanje i poravnavanje	6843	837876-0	1	DDF448	837916-4	2	DHP483	837670-0	2
Pribor za višenamenski alat	6906	838024-4	2	DDF453	837916-4	2	DHP484	837916-4	2
Pribor za testere	9046	838025-2	2	DDF456	837916-4	2	DHP485	837916-4	2
Pribor za pneumatike alate	9403	837652-2	3	DDF458	837916-4	2	DHR162	838109-6	3
Pribor za fenove za vrući vazduh	9404	837653-0	3	DDF459	837916-4	2	DHR164	838109-6	3
Pribor za usisavanje	9741	838026-0	3	DDF470	837916-4	2	DHR165	838109-6	3
Pribor za alate za rad na otvoreno	9910	837658-0	3	DDF480	837916-4	2	DHR171	839387-1	3
Pribor za alate za rad na zaštitna	9911	837658-0	3	DDF481	837916-4	2	DHR202	837634-4	3
Koferi i torbe	BBO140	837809-5	2	DDF482	837916-4	2	DHR241	837641-7	3
Ručni alati	BDF441	837916-4	2	DDF483	837670-0	2	DHR242	835A31-4	4
Ostalo	BDF451	837916-4	2	DDF484	837916-4	2	DHR242	837649-1	4
Pribor za mješanje	BDF452	837916-4	2	DDF485	837916-4	2	DHR243	835A31-4	4
	BDF454	837916-4	2	DF+TD	838439-5	1	DHR243	837649-1	4
	BHP441	837916-4	2	DF001G	835F93-2	3	DHR263	837988-9	4
	BHP451	837916-4	2	DF002G	835U77-0	2	DHR263+DDF	838316-1	4
	BHP452	837916-4	2	DF010D	837871-0	1	DHR263+DHP	838316-1	4
	BHP454	837916-4	2	DF030D	837866-3	1	DHR264	837988-9	4
	BHR162	838109-6	3	DF031D	838312-9	1	DHR280	835A32-2	4
	BHR242	835A31-4	4	DF033D	838312-9	1	DHR280	839559-8	4
	BHR243	835A31-4	4	DF330D	837866-3	1	DHR281	839559-8	4
	BHR262	837650-6	4	DF331D	838312-9	1	DHR282	839559-8	4
	BJN160	837678-4	2	DF332D	838312-9	1	DHR283	839559-8	4
	BO4555	838029-4	2	DF333D	838312-9	1	DHS630	837635-2	4
	BO4565	838029-4	2	DF347D	838267-8	2	DHS660	839752-4	3
	BO4900V	837675-0	2	DFN350	835B51-4	2	DHS661	839752-4	3
	BO4901	837675-0	2	DFR440	837631-0	3	DHS680	838182-6	3
	BO5031	837874-4	2	DFR540	837631-0	3	DHS710	837861-3	4
	BO5041	837874-4	2	DFR550	837631-0	3	DHS782	835C85-3	4
	BO6030	837654-8	3	DFS250	837805-3	2	DHS783	835C85-3	4
	BO6040	837655-6	3	DFS251	837805-3	2	DJN161	837678-4	2
	BO6050	838246-6	3	DFS441	837805-3	2	DJR183	837897-2	2
	BPJ140	837648-3	3	DFS451	837805-3	2	DJR188	839458-4	3
	BSS500	837628-9	3	DFS452	837805-3	2	DJS101	837636-0	2
	BSS501	837628-9	3	DGA450	837632-8	3	DJS130	838302-2	2
	BTP130	837670-0	2	DGA452	837632-8	3	DJS160	837636-0	2
	CA5000	838390-9	4	DGA504	838175-3	3	DJS161	837636-0	2
	CC300D	837879-4	3	DGA504	839252-4	3	DJV140	837639-4	2
	CC301D	838568-4	3	DGA504	839355-4	3	DJV180	837639-4	2
	DA3010F	837880-9	1	DGA506	838175-3	3	DJV181	837789-5	3
	DA3011F	837880-9	1	DGA508	838175-3	3	DJV182	837639-4	2
	DA330D	837695-4	1	DGA511	839252-4	3	DKP180	837808-7	3
	DA331D	837695-4	1	DGA513	839252-4	3	DKP181	835E27-9	3
	DA332D	839304-1	1	DGA514	839252-4	3	DP2010	838030-9	1
	DA333D	839304-1	1	DGA517	839252-4	3	DP2011	838030-9	1
	DBO140	837809-5	2	DGA519	839252-4	3	DP3003	838039-1	1
	DBO180	837809-5	2	DGD800	837806-1	2	DP4001	838039-1	1
	DCO180	838062-6	1	DHK180	835D35-4	4	DP4003	838039-1	1
	DCS550	837628-9	3	DHP343	837916-4	2	DP4011	838039-1	1

# Makpac unutrašnje obloge za alate

MODEL ALATA	UNUTRAŠNJA POLICA	MAKPAC KOFER
DP4700	837872-8	1
DPJ180	837648-3	3
DPT350	837640-9	2
DPT351	837640-9	2
DPT353	839128-5	2
DPV300	835V03-5	2
DRT50	837247-1	4
DRV150	835A34-8	3
DRV250	835A34-8	3
DS4012	838181-8	3
DSC102	839527-1	3
DSP600	839290-6	4
DSP601	839290-6	4
DSS610	837642-5	3
DST110	837640-9	2
DST220	837640-9	2
DST221	837640-9	2
DTD129	837670-0	2
DTD134	837670-0	2
DTD136	837670-0	2
DTD137	837670-0	2
DTD146	837670-0	2
DTD147	837670-0	2
DTD148	837670-0	2
DTD152	837670-0	2
DTD153	837670-0	2
DTD154	837670-0	2
DTD170	837670-0	2
DTL060	837644-1	2
DTL061	837644-1	2
DTL062	837644-1	2
DTL063	837644-1	2
DTM50	837671-8	3
DTM51	837671-8	3
DTM52	835W93-4	3
DTP131	837670-0	2
DTP140	837670-0	2
DTP141	837670-0	2
DTR180	839735-4	4
DTS130	837670-0	2
DTS141	837670-0	2
DTW1001	837645-9	3
DTW1002	837645-9	3
DTW181	837298-4	2
DTW181	837670-0	2
DTW190	838550-3	2
DTW250	837670-0	2
DTW251	837670-0	2
DTW281	837670-0	2
DTW285	837670-0	2
DTW300	835L10-8	2
DTW301	835L10-8	2
DTW450	837645-9	3
DTW800	837645-9	3
FS2300	838030-9	1
FS2500	838030-9	1
FS2700	838030-9	1
FS4000	838030-9	1

MODEL ALATA	UNUTRAŠNJA POLICA	MAKPAC KOFER
FS4300	838030-9	1
FS6300	838030-9	1
GA005G	835E79-0	4
GA008G	835E79-0	4
GA023G	835E79-0	4
GA029G	835E79-0	4
GA5030	837920-3	2
GA5040	837672-6	2
GA5041	837672-6	2
HPO02G	835U77-0	2
HP1630	838038-3	1
HP1631	838038-3	1
HP1640	838038-3	1
HP1641	838038-3	1
HP2050	838039-1	1
HP2051	838039-1	1
HP2070	838039-1	1
HP2071	838039-1	1
HP330D	837866-3	1
HP331D	838312-9	1
HP332D	838312-9	1
HP333D	838312-9	1
HR002G	835C84-5	4
HR004G	835C84-5	4
HR140D	839245-1	2
HR166D	839245-1	2
HR1841F	839214-2	1
HR2300	837651-4	2
HR2600	837651-4	2
HR2610	837651-4	2
HR2611FT	837914-8	2
HR2630T	837914-8	2
HR2631FT	837914-8	2
HR2652	839975-4	4
HR2811FT	837868-9	2
HR3001	835B26-3	2
HR3011	835B25-5	4
HR3012FC	835B25-5	4
HS003G	835K81-9	4
HS004G	835K82-7	4
HS300D	837662-9	2
HS301D	838315-3	2
HS6101	837807-9	4
HS6601	838314-5	3
HS7101	837807-9	4
HS7601	838108-8	4
HS7611	839500-1	4
JN1601	837882-5	1
JN3201	837630-2	2
JR100D	837664-5	1
JR102D	837664-5	1
JS1000	838027-8	1
JS1601	838027-8	1
JS1602	837882-5	1
JS3201	837630-2	2
JV0600	837803-7	1
JV100D	837665-3	1
JV101D	838563-4	1

MODEL ALATA	UNUTRAŠNJA POLICA	MAKPAC KOFER
JV102D	839186-1	1
JV103D	839186-1	1
KP0800	837659-8	3
KP0810	837659-8	3
PJ7000	837661-1	3
PT354D	839166-7	1
RP0900	837646-7	2
RP0910	837660-3	2
RP110C	837660-3	2
RP1800	837647-5	4
RP1801	837647-5	4
RP1803F	8352F0-3	4
RP2300	837647-5	4
RP2301	837647-5	4
RP2303FC	8352F0-3	4
RT0700C	837247-1	4
SA5040C	837672-6	2
SG1251	838111-9	4
SP001G	8351E4-2	4
SP6000	837945-7	4
SP6000	838390-9	4
ST113D	839019-0	1
TD001G	835F94-0	2
TD021D	837871-0	1
TD090D	837866-3	1
TD110D	838312-9	1
TD111D	838312-9	1
TL064D	839287-5	1
TL065D	839287-5	1
TM3000	837673-4	2
TM30D	838612-7	2
TW001G	835K85-1	3
TW007G	835K85-1	3
TW0200	837869-7	1
TW0350	837870-2	2
TW100D	837866-3	1
TW161D	838312-9	1

MODEL ALATA	UNUTRAŠNJA POLICA	PLASTIČNI KOFER
HR4003C	837544-5	196277-4
HR4013C	837544-5	196278-2
HR5202C	837860-5	196552-8
HR5212C	837860-5	196553-6

PRIBOR	UNUTRAŠNJA POLICA	MAKPAC KOFER
LXT aku. + punjač	837948-1	1
4x LXT aku. + punjač	838110-1	1
4x LXT aku. + punjač sa dva porta	839205-3	3
8x LXT akumulator	839742-7	1, 2, 3, 4

- Akumulat ori i punjači
- Pribor za akumulat orske alate
- Akumulat orske lampe i pribor
- Pribor za laserske merace
- Pribor za rušenje i udarno bušenje
- Pribor za bušenje
- Krunaste testere
- Pribor za pritezanje
- Pribor za sečenje i bušenje
- Pribor za bušenje i poliranje
- Pribor za profilisanje i poravnanje
- Pribor za višenam eniski alat
- Pribor za testere
- Pribor za pneumat ske alate
- Pribor za fenove za vrući vazduh
- Pribor za usisivanje
- Pribor za alate za rad na otvoreno
- Pribor za držače alata i zaštitna
- Koferi i torbe
- Ručni alati
- Ostalo
- Pribor za mješanje

	MODEL	ID BROJ	TIP	MODEL	ID BROJ	TIP	MODEL	ID BROJ	TIP
Akumulat ori i punjači	1806B	821134-4	L	BHP456	141856-3	P	DF488D	821844-3	P
Pribor za akumulat orske alate	2012NB	824002-0	P	BHR202	824861-2	P	DFR440	140392-6	P
Akumulat orske lampe i pribor	4112HS	824697-9	P	BHR240	824771-3	P	DFR540	141352-1	P
Pribor za laserske merace	4326	824572-9	P	BHR241	824771-3	P	DFR550	141352-1	P
Pribor za rušenje i udarno bušenje	4327	824572-9	P	BHR261	824874-3	P	DFR750	141352-1	P
Pribor za bušenje	4329	824572-9	P	BHR261T	824874-3	P	DFS250	821645-9	P
Krunaste testere	4340CT	824809-4	P	BJR181	141354-7	P	DFS251	821645-9	P
Pribor za pritezanje	4341CT	824809-4	P	BJR181	824760-8	P	DFS441	821645-9	P
Pribor za sečenje i brušenje	4341FCT	824809-4	P	BJV140	824775-5	P	DFS451	821645-9	P
Pribor za poliranje	4350CT	824809-4	P	BJV180	824775-5	P	DFS452	821645-9	P
Pribor za profilisanje i poravnavanje	4350FCT	824809-4	P	BO4555	824806-0	P	DGA450	141257-5	P
Pribor za višenamenski alat	4351CT	824809-4	P	BO4557	824806-0	P	DGA452	141257-5	P
Pribor za testere	4351FCT	824809-4	P	BO4565	824806-0	P	DGA504	821636-0	P
Pribor za pneumatike alate	4604D	824556-7	P	BO5030	824562-2	P	DGA506	821636-0	P
Pribor za fenoventilator za vrući vazduh	5603R	824964-2	P	BO5031	824562-2	P	DGA701	821717-0	P
Pribor za usisavanje	5604R	824555-9	P	BO6040	824591-5	P	DGA900	821717-0	P
Pribor za alate za otvoreno rad na zaštitna	5703R	824964-2	P	BPB180	141496-7	P	DGA901	821717-0	P
Koferi i torbe	5705R	824964-2	P	BSS610	824757-7	P	DGP180	821840-1	P
Ručni alati	5903R	193196-5	P	BTD130F	141205-4	P	DHG180	PR0000404	P
Ostalo	6270D	824581-8	P	BTD140	141205-4	P	DHG181	PR0000404	P
Pribor za mješanje	6305	182114-8	K	BTD144	141205-4	P	DHP343	158777-2	P
	6842	824808-6	P	BTD441	140354-4	P	DHP446	141856-3	P
	6843	824808-6	P	BTP130	141205-4	P	DHP453	158777-2	P
	6904VH	824439-1	P	BTP140	141205-4	P	DHP456	141856-3	P
	6905H	824698-7	P	BTW152	141205-4	P	DHP458	821524-1	P
	6906	182604-1	K	BTW251	141205-4	P	DHP459	158597-4	P
	6940D	824686-4	P	BTW450	141644-8	P	DHP481	821524-1	P
	6953	824630-1	P	CG100D	821710-4	P	DHP482	141856-3	P
	8280D	824581-8	P	DA330D	821556-8	P	DHP483	141856-3	P
	8391D	824853-1	P	DA4000LR	824646-6	P	DHP484	158597-4	P
	9558HNG	824985-4	P	DBM130	P-45141	K	DHR202	141642-2	P
	9565	182875-0	K	DBM131	P-45141	K	DHR241	141643-0	P
	AF505N	HY00000090	P	DCG180	821568-1	P	DHR242	141401-4	P
	AN510H	824793-3	P	DCS55ORFJ	141485-2	P	DHR263	142551-8	P
	AN610H	824490-1	P	DDA341	141358-9	P	DHR400	821746-3	P
	AN621	824582-6	P	DDA350	141358-9	P	DHS630	824995-1	P
	AN901	824545-2	P	DDA450	821856-6	P	DJN161	142004-7	P
	AT638	A0905-0361	P	DDF083	141856-3	P	DJR183	821586-9	P
	BDF441	824754-3	P	DDF343	158777-2	P	DJR186	821620-5	P
	BDF442	824774-7	P	DDF446	141856-3	P	DJR187	821620-5	P
	BDF444	824754-3	P	DDF453	158777-2	P	DJR360	821620-5	P
	BDF451	824754-3	P	DDF456	141856-3	P	DJV140	141486-0	P
	BDF452	824774-7	P	DDF458	821524-1	P	DK18062	821599-0	P
	BDF454	824754-3	P	DDF459	158597-4	P	DKP180	824982-0	P
	BDF456	141856-3	P	DDF481	821524-1	P	DP3003	824595-7	P
	BFS451	141490-9	P	DDF482	141856-3	P	DP4001	824595-7	P
	BFS451	821645-9	P	DDF483	141856-3	P	DP4003	824595-7	P
	BFS451	824978-1	P	DDF484	158597-4	P	DPJ180	141533-7	P
	BGA450	824767-4	P	DF012DSE	824781-0	P	DPP200	SC09009190	P
	BGA452	824767-4	P	DF030D	824842-6	P	DSC191	SC09009190	P
	BHP441	824754-3	P	DF031D	821661-1	P	DSC250	SC09009190	P
	BHP442	824774-7	P	DF330D	824842-6	P	DSC251	SC09009190	P
	BHP451	140354-4	P	DF331D	821661-1	P	DST110	141074-3	P
	BHP451	824754-3	P	DF332D	821661-1	P	DST220	141074-3	P
	BHP452	824774-7	P	DF347D	824981-2	P	DST221	141074-3	P
	BHP454	824754-3	P	DF457D	824981-2	P	DTD129	824979-9	P



# Transportni koferi i torbe

MODEL	ID BROJ	TIP	MODEL	ID BROJ	TIP	MODEL	ID BROJ	TIP
DTD146	824979-9	P	HP331D	821661-1	P	HS7101	141736-3	P
DTD148	824979-9	P	HP332D	821661-1	P	HS7601	821622-1	P
DTD152	141856-3	P	HP347D	824981-2	P	JN3200	181797-1	K
DTD153	824979-9	P	HP457D	824981-2	P	JR001G	821796-8	P
DTD154	824979-9	P	HP488D	821844-3	P	JR100D	824993-5	P
DTD155	141856-3	P	HR005G	821837-0	P	JR103D	821662-9	P
DTD170	824979-9	P	HR006G	821848-5	P	JR105D	821662-9	P
DTD171	821750-2	P	HR007G	821864-7	P	JR3050T	821621-3	P
DTLO60	141493-3	P	HR166D	183H61-4	P	JR3060T	821621-3	P
DTM50	141562-0	P	HR1830	824650-5	P	JR3061T	821718-8	P
DTP141	824979-9	P	HR1840	821706-5	P	JR3070CT	821621-3	P
DTS141	824979-9	P	HR2020	824650-5	P	JS3200	181797-1	K
DTW190	141856-3	P	HR2300	821775-6	P	JV0600	824998-5	P
DTW250	141205-4	P	HR2440	824650-5	P	JV100D	821508-9	P
DTW251	141205-4	P	HR2450	824650-5	P	JV101D	821691-2	P
DTW281	824979-9	P	HR2470	824799-1	P	KP0800	824892-1	P
DTW285	824979-9	P	HR2470T	824799-1	P	KP0810	824786-0	P
DUC122	141494-1	P	HR2600	821775-6	P	LCT204	823304-1	A
DVP180	ASOVP007MK	A	HR2610	140402-9	P	MT060	183517-9	P
DVR450	141481-0	P	HR2610T	140404-5	P	MT064	183693-9	P
DVR850	141481-0	P	HR2611	140403-7	P	MT065	183693-9	P
FS2700	824890-5	P	HR2611F	140401-1	P	NI923B	P-72366	P
GA4530	824985-4	P	HR2611FT	140403-7	P	PJ7000	821509-7	P
GA5030	823294-8	A	HR2630	821775-6	P	SG1250	824709-8	P
GA9020	824958-7	P	HR2630T	824916-3	P	SG150	B50856	K
HG5012K	HG130442	P	HR2631F	821775-6	P	SG180	B50856	K
HG551VK	HG130442	P	HR2631FT	821775-6	P	SG181	B50856	K
HG651CK	HG130442	P	HR2641	824695-3	P	TD090D	824842-6	P
HK0500	824523-2	P	HR2650	821724-3	P	TD110D	821661-1	P
HK1810	150640-5	P	HR2650	821781-1	P	TD111D	821661-1	P
HK1820	824789-4	P	HR2651	821722-7	P	TD126D	824981-2	P
HM001G	141D88-6	P	HR2651	821780-3	P	TDI27D	824981-2	P
HM002G	821848-5	P	HR2651T	821722-7	P	TM3000C	821596-6	P
HMO870C	824905-8	P	HR2651T	821780-3	P	TM30D	143644-4	P
HMO871C	824905-8	P	HR2652	821781-1	P	TW001G	821828-1	P
HM1101C	140562-7	P	HR2653	821780-3	P	TW0350	824702-2	P
HM1111C	140562-7	P	HR2653T	821780-3	P	TW1000	824737-3	P
HMI203C	824876-9	P	HR2800	824789-4	P	TW100D	824781-0	P
HMI213C	824908-2	P	HR2810	824789-4	P			
HMI214C	824882-4	P	HR2811F	824789-4	P			
HMI304	183567-4	K	HR2811FT	824789-4	P			
HMI304B	183598-3	K	HR3200C	824825-6	P			
HMI307C	824898-9	P	HR3210C	824825-6	P			
HMI307CB	824898-9	P	HR3210FCT	824825-6	P			
HM1501	821839-6	P	HR3540C	824825-6	P			
HM1502	821839-6	P	HR4001C	140760-3	P			
HM1512	821839-6	P	HR4002	824798-3	P			
HP1640	824923-6	P	HR4003C	196277-4	P			
HP1641	824923-6	P	HR4010C	196183-3	P			
HP2050	824650-5	P	HR4013C	196531-6	P			
HP2051	824650-5	P	HR4500C	824607-6	P			
HP2051F	824650-5	P	HR4501C	158275-6	P			
HP2070	824650-5	P	HR5202C	196552-8	P			
HP2071	824650-5	P	HS009G	821866-3	P			
HP2071F	824650-5	P	HS300D	824961-8	P			
HP330D	821525-9	P	HS301D	821663-7	P			

**P:** plastični kofer **K:** metalni kofer  
**T:** torba za alat **L:** drveni kofer

Akumulat	ori i punjači
Pribor za akumulat	orske lampe i pribor
Akumulat	orske lampe i pribor
Pribor za laserske	merace
Pribor za rušenje i udarno bušenje	
Pribor za bušenje	
Krunaste testere	
Pribor za pritezanje	e
Pribor za sečenje i bušenje	
Pribor za brušenje i poliranje	
Pribor za profilisanje i poravnavanje	
Pribor za višenamenski alat	
Pribor za testere	
Pribor za pneumatike alate	
Pribor za feneve za vrući vazduh	
Pribor za usisivanje	e
Pribor za alate za rad na otvoreno	
Pribor za držače alata i zaštitna	
Koferi i torbe	
Ručni alati	
Ostalo	
Pribor za mješanje	

# Strap Belt sistemi

## Koristite kao rameni pojas

STRAP BELT SISTEM je jedinstveni pojas sa kopčama sa brzim otpuštanjem za višenamensku upotrebu. Remen je opremljen mekanom gumenom podloškom za rame za udobnije podizanje i nošenje.



## Koristite kao kaiš

STRAP BELT se lako može odvojiti od bilo koje torbe i koristi se kao kaiš za kačenje alata. Lako ih razlikuju dimenzionisanje za maksimalnu udobnost i opciju kombinovanje sa bilo kojim držačem i futrolom za alat iz STRAP BELT sistem.



**E-05446**  
Torba za alat sa poklopcem



**E-05418**  
Torba za alat



**E-05620**  
Torba za nošenje hrane sa remenom



**E-05614**  
Torba za nošenje hrane



**E-05256**  
Univerzalni držač alata



**E-05212**  
Torbica za električare za četiri pozicije nošenja



**E-05480**  
Četvorostrana torba za alat



**E-05474**  
Torbica za alat za rame ili pojas

**STRAP BELT SYSTEM**



**Više od 40**  
**kompatibilnih artikala**



**E-05153**  
Tesarska-univerzalna torbica



**E-05228**  
Torbica za čekić i druge alate za tri pozicije nošenja



**E-05234**  
Bočni držač čekića i alata



**E-05240**  
Držač čekića ili sekire



**E-05549**  
Torba za lančanu testeru



**E-10920/E-10936**  
Futrola za nošenje šine za sečenje 1,9 m/3 m



**E-05670/E-05664**  
Futrola za nošenje šine za sečenje 1 m/1,5 m



**E-05505**  
Torba za tehnička lica za alat i laptop



**E-05561**  
Torba višenamenska



**E-05206**  
Torbica sa pregradom na kopčanje za baterije ili vijke



**E-05496**  
Platnena polu-tvrda torba za alat



**E-05094**  
Držač bušilice univerzalni L/D



**E-05119**  
Držač udarnog odvijača univerzalni L/D



**E-05197**  
Torbica za građevinu sa držačem za čekić



**E-05181**  
Torbica za električare



**E-05125**  
Univerzalna torbica za ručni alat i bušilicu



**E-05608**  
Termo šolja sa držačem za kaiš



**E-05147**  
Torbica sa tri džepa za ručni alat i vijke



**E-05599**  
Termo posuda sa držačem za kaiš



**E-05583**  
Torbica za telefon



**E-12980**  
Torbica za telefon XL

# Tehnička rešenja treće generacije držača alata



**Strap Belt Sistem** je jedinstvena traka sa brzim kopčama koje se lako mogu odvojiti od TORBI za alat i koristi se kao kaiš za alat. Kaiš je kompatibilan sa svim torbama, držačima i torbicama za alat iz ovog sistema.



**3L tehnologija** je jedinstveni troslojni kompozit od poliesteru i pena koja osigurava visoku trajnost, otpornost na vodu i male težine. Inovativna struktura kompozita može lako biti oblikovani u različite strukture.



**Vodootporno dno** je izuzetno važno za kvalitet torbi za alat. Čvrsto, izdržljivo i vodootporno dno štiti torbu i alate od vode i prljavštine.



**Prava koža** je spolja glatka sa brušenim antilopom iznutra. Snažana i izdržljiva za dug radni vek, ali mekana i dovoljno gipka za bolji komfor. Za proizvode posebno izloženi habanju, koristili smo deblju kožu - 1,8 do 2,0 mm - osiguravajući proizvode vrhunskog kvaliteta u čitavom asortimanu.



**Izdržljivo zakivanje** za izuzetno čvrste veze. Jake zakovice sa podloškama koriste se u svim oblastima visokog napora. U određenim vezama koje zahtevaju dodatnu izdržljivost koristili smo 1 ili 2 podloške; sa jedne ili sa obe strane.



**Rešenje protiv klizanja** minimizira ili čak sprečava nezgode na radnom mestu. Visokokvalitetna polipropilenska traka sa gumirnom površinom koja vam pomaže da alate držite na mestu i obezbeđuje dodatnu zaštitu kućišta alata.



















**Elastične trake** osiguravaju vaše alate i pribor na mestu gde će biti sigurne za transportovanje. Njihova prilagodljivost nudi beskrajne mogućnosti za organizaciju alata, dok njihova elastičnost osigurava čvrsto prijanjanje bilo kog alata ili pribor. Elastične trake su korišćene u širokoj paleti naših proizvoda kako biste bili sigurni da ćete dobiti maksimalnu upotrebljivost svakog našeg proizvoda.













**Click-holder** omogućava jednostavno pričvršćivanje čekića/sekire korisniku da brzo odloži/uzme alat bez gledanja. Sistem je zasnovan na sistemu dvostrano skolpivih vrata što osigurava da je vaš alat uvek pod optimalnim uglom. Držač je napravljen od nerđajućeg čelika i pričvršćen za 4 zakovice obezbeđujući kvalitet spoja i duži vek trajanja.









## Torbice i držači

Model	Opis	Veličina (mm)			Karakteristike								
		V	D	Š	STRAP/BELT SYSTEM	3 LAYERS	WATERPROOF BOTTOM	REAL LEATHER	DURABLE RIVETING	ANTI SLIP	ELASTIC LOOPS	SIDE-GATE SOLUTION	
	E-05094 Držalac bušilice univerzalni L/D	290	170	85	✓	✓		✓	✓	✓	✓		
	E-05119 Držalac udarnog odvijača univerzalni L/D	235	155	75	✓	✓		✓	✓	✓	✓		
	E-05125 Univerzalna torbica za ručni alat i bušilicu	270	260	145	✓	✓		✓	✓	✓	✓		
	E-05147 Torbica sa tri džepa za ručni alat i vijke	270	320	145	✓	✓		✓	✓	✓	✓		
	E-05153 Tesarska-univerzalna torbica	270	290	145	✓	✓		✓	✓	✓	✓	✓	
	E-05169 Trodelna torbica za alat na kaišu	270	640	145		✓		✓	✓	✓	✓	✓	
	E-05175 Pojas sa torbicama za veći broj alata	310	880	170	✓	✓		✓	✓	✓	✓		
	E-05181 Torbica za električare	310	250	125	✓	✓		✓	✓	✓	✓		
	E-05197 Torbica za građevinu sa držačem za čekić	185	180	105	✓	✓		✓	✓	✓	✓		
	E-05206 Torbica sa pregradom na kopčanje za baterije ili vijke	185	175	105	✓	✓			✓		✓		
	E-05212 Torbica za električare za četiri pozicije nošenja	205	185	55	✓			✓	✓		✓		
	E-05228 Torbica za čekić i druge alate za tri pozicije nošenja	205	185	85	✓			✓	✓		✓		
	E-05234 Bočni držalac čekića i alata	165	110	70	✓	✓			✓		✓	✓	
	E-05240 Držalac čekića ili sekire	165	110	65	✓	✓			✓		✓		
	E-05256 Univerzalni držalac alata	165	110	15	✓	✓			✓		✓		
	E-05262 Torbica za noževa i ostalih sečiva	200	100	50	✓	✓			✓	✓	✓		

## Kaiševi i Rameni pojasevi

Model	Opis	Veličina (mm)			Karakteristike									
		V	D	Š	STRAP/BELT SYSTEM	3 LAYERS	WATERPROOF BOTTOM	REAL LEATHER	DURABLE RIVETING	ANTI SLIP	ELASTIC LOOPS	SIDE-GATE SOLUTION		
	E-05290 Platneni kaiš sa brzom kopčom (opciono kao remen)	38	1.300	-	✓									
	E-05309 Gajka za kačenje - 3kom	129	41	-	✓									
	E-05321 Postavljeni pojas sa gajkama	100	880	30				✓	✓					
	E-05337 Pojas sa kopčom za brzo skidanje	50	1.550	-										
	E-05343 Kožni kaiš sa gajkama	48	1.380	-				✓						
	E-05359 Kožni kaiš crni M	38	1.130	-				✓						
	E-05365 Kožni kaiš crni L	38	1.330	-				✓						
	E-05371 Kožni kaiš braon M	38	1.130	-				✓						
	E-05387 Kožni kaiš braon L	38	1.330	-				✓						
	E-05393 Postavljeni tregeri sa futrolom za telefon	410	520	23						✓				
	E-05402 Tregeri	-	50	-										













## Torbe i ranci

Model	Opis	Veličina (mm)			Karakteristike									
		V	D	Š	STRAP/BELT SYSTEM	3 LAYERS	WATERPROOF BOTTOM	REAL LEATHER	DURABLE RIVETING	ANTI SLIP	ELASTIC LOOPS	SIDE-GATE SOLUTION		
	E-05418 Torba za alat	310	510	300	✓		✓		✓		✓			
	E-05446 Torba za alat sa poklopcem	360	490	310	✓		✓		✓		✓			
	E-05474 Torbica za alat za rame ili pojas	225	350	175	✓	✓				✓	✓			
	E-05480 Četvorostrana torba za alat	410	260	220	✓				✓	✓	✓			
	E-05496 Platnena polu-tvrda torba za alat	270	520	250	✓	✓				✓	✓			
	E-05505 Torba za tehnička lica za alat I laptop	350	425	170	✓	✓			✓		✓			



# Koferi i torbe

## Ostale torbe za alat

Model	Naziv	Za model	Dimenzije (D x Š x V) (mm)	Cena sa PDV-om	
168467-9	Futrola	DF030D, DF330D	150 x 120 x 40		
195638-5	Torba za alat	DSL800, DSL801, DUX60, UX01G, DUX18	1.200 x 300 x 350		
198589-1	Torba za alat	CP100D	330 x 190 x 130		
199297-7	Torbica za baterije	2 x BL18XX	170 x 70 x 110		
199901-8	Torba za alat	DCL281, CL001G	630 x 230 x 190		
831253-8	Torba za alat	/	350 x 200 x 250		
831271-6	Torba za alat	/	560 x 280 x 300		
831276-6	Torba za alat	TD020D, TD021D	305 x 240 x 95		
831279-0	Torba za alat	/	700 x 380 x 300		
831303-9	Torba za alat	DPB181	720 x 320 x 330		
831327-5	Torba za alat	RT0700C, RT0702C	410 x 350 x 105		
832074-1	Torba za alat	/	350 x 250 x 300		
832188-6	Torba za usisavač	CL121D	490 x 230 x 230		

Nastavak...

- Akumulat  
ori i  
punjači
- Pribor za  
akumulat  
orske  
alate
- Akumulat  
orske  
lampe i  
pribor
- Pribor za  
laserske  
merace
- Pribor za  
rušenje i  
udarno  
bušenje
- Pribor za  
bušenje
- Krunaste  
testere
- Pribor za  
pritezanje
- Pribor za  
sečenje i  
brusenje
- Pribor za  
brusenje  
i  
poliranje
- Pribor za  
profilisanje  
i  
poravnanje
- Pribor za  
višenam  
enski alat
- Pribor za  
testere
- Pribor za  
pneumat  
ske alate
- Pribor za  
fenove  
za vrući  
vazduh
- Pribor za  
usisivanje
- Pribor za  
alate za  
rad na  
otvoreno
- Pribor za  
držače  
alata i  
zaštitna
- Koferi i  
torbe
- Ručni  
alati
- Ostalo
- Pribor za  
mješanje

	Model	Naziv	Za model	Dimenzije (D x Š x V) (mm)	Cena sa PDV-om
	832319-7	Torba za alat	/	350 x 220 x 200	
	832366-8	Torba za alat	/	700 x 310 x 320	

Akumulat ori i punjači
Pribor za akumulat orske alate
Akumulat orske lampe i pribor
Pribor za laserske merace
Pribor za rušenje i udarno bušenje
Pribor za bušenje
Krunaste testere
Pribor za pritezanje
Pribor za sečenje i brusenje
Pribor za brusenje i poliranje
Pribor za profilisanje i poravnav
Pribor za višenam enski alat
Pribor za testere
Pribor za pneumat ske alate
Pribor za fenove za vrući vazduh
Pribor za usisivanje
Pribor za alate za rad na otvoreno
Pribor za držače alata i zaštitna
<b>Koferi I torbe</b>
Ručni alati
Ostalo
Pribor za mješanje



# RUČNI ALATI



## Univerzalna klešta

## Univerzalna klešta



Model	Naziv	Dužina (D) (mm)	Prečnik Ø (mm)	Cena sa PDV-om
B-65486	Vodoinstalaterska klešta 250mm	250	51	
B-65492	Vodoinstalaterska klešta 300mm	300	76	

## Univerzalna klešta



Model	Naziv	Dužina (D) (mm)	Prečnik Ø (mm)	Cena sa PDV-om
B-65741	Vodoinstalaterska klešta	180	37	
B-65757	Vodoinstalaterska klešta	240	49	
B-65763	Vodoinstalaterska klešta	300	68	

## Podesivi ključ

## Podesivi ključ



Model	Naziv	Dužina (D) (mm)	Prečnik Ø (mm)	Cena sa PDV-om
B-65414	Podesivi ključ 150mm	150	29	
B-65420	Podesivi ključ 200mm	200	36	
B-65436	Podesivi ključ 250mm	250	38	
B-65442	Podesivi ključ 300mm	300	43	

## Francuski ključ sa zaključavanjem

Pritezanje vijaka ili navrtki i pričvršćivanje metalnih ploča ima mogućnost stezanja materijala i zaključavanja kao prilikom rada sa steznim kleštima



Model	Naziv	Dužina (D) (mm)	Prečnik Ø (mm)	Cena sa PDV-om
B-65470	Ključ za podešavanje sa zaključavanjem	250	35	





## Vilasto okasti ključevi



Model	Naziv	Veličina nasada (mm)	Cena sa PDV-om
E-11586	Vilasto okasti ključ 8mm	8	
E-11592	Vilasto okasti ključ 10mm	10	
E-11601	Vilasto okasti ključ 12mm	12	
E-11617	Vilasto okasti ključ 13mm	13	
E-11623	Vilasto okasti ključ 14mm	14	
E-11639	Vilasto okasti ključ 15mm	15	
E-11645	Vilasto okasti ključ 16mm	16	
E-11651	Vilasto okasti ključ 17mm	17	
E-11667	Vilasto okasti ključ 18mm	18	
E-11673	Vilasto okasti ključ 19mm	19	

## Kompleti



Model	Naziv	Veličina nasada (mm)	Cena sa PDV-om	
B-65458	Set 11kom prolaznih ključeva I podesivi ključ	10, 11, 12, 13, 14, 15, 16, 17, 18, 19		
B-65523	Set dvostranih ključeva sa čegrtaljkom	8, 10, 12, 13, 14, 15, 17, 19		
B-65539	Set okasto vijuškastih ključeva	8, 10, 12, 13, 14, 15, 16, 17, 18		
B-65545	Set blago zakrivljenih vijuškastih ključeva	9×11, 10×12, 13×14, 15×17, 16×18		
B-65551	Set okastih ključeva	8×9, 10×11, 12×13, 14×15, 18×19		

Akumulat  
ori i  
punjači

Pribor za  
akumulat  
orske  
alate

Akumulat  
orske  
lampe i  
pribor

Pribor za  
laserske  
merace

Pribor za  
rušenje i  
udarno  
bušenje

Pribor za  
bušenje

Krunaste  
testere

Pribor za  
pritezanje

Pribor za  
sečenje i  
brusjenje

Pribor za  
brusjenje  
i  
poliranje

Pribor za  
profilisanje  
i  
poravnava

Pribor za  
višenam  
enski alat

Pribor za  
testere

Pribor za  
pneumat  
ske alate

Pribor za  
fenove  
za vrući  
vazduh

Pribor za  
usisivanje

Pribor za  
alate za  
rad na  
otvoreno

Pribor za  
držače  
alata i  
zaštitna

Koferi i  
torbe

Ručni  
alati

Ostalo

Pribor za  
mješanje

## Račne



Model	Naziv	Prihvati	Cena sa PDV-om
E-11558	Račna 1/4" SQ, 84Z	1/4"	
E-11564	Račna 3/8" SQ, 84Z	3/8"	
E-11570	Račna 1/2" SQ, 84Z	1/2"	

## Imbus ključ



## Imbus ključ

Model	Naziv	Veličina	Cena sa PDV-om
B-65894	Imbus set ključeva 9kom.	1,5, 2, 2,5, 3, 4, 5, 6, 8, 10	

## Čekići



## Čekići

Standardni čekić sa kukom za hvatanje i vađenje eksera. Izliven iz jednog komada za veću snagu i izdržljivost u radu.

Model	Naziv	Dužina (D) (mm)	Težina (kg)	Cena sa PDV-om
B-65779	Tesarski čekić	250	0,57	

Akumulat  
ori i  
punjačiPribor za  
akumulat  
orske  
alateAkumulat  
orske  
lampe i  
priborPribor za  
laserske  
meracePribor za  
rušenje i  
udarno  
bušenjePribor za  
bušenjeKrunaste  
testerePribor za  
pritezani  
ePribor za  
sečenje i  
brusenjePribor za  
brusenje  
i  
poliranjePribor za  
profilisanj  
e i  
poravnajPribor za  
višenam  
enski alatPribor za  
testerePribor za  
pneumat  
ske alatePribor za  
fenove  
za vrući  
vazduhPribor za  
usisivanj  
ePribor za  
alate za  
rad na  
otvorenoPribor za  
držače  
alata i  
zaštitnaKoferi i  
torbeRučni  
alati

Ostalo

Pribor za  
mješanje

## Komplet ključeva sa čegrtaljkom



### Komplet ključeva sa čegrtaljkom

Drška ključa sa čegrtaljkom sa mehanizmom sa 84 zubaca Rad pod uglom od 4,3°

Model	Naziv	Priključak (mm)	Pribor	Cena sa PDV-om	
B-65567	34-delni komplet ključa sa čegrtaljkom i priključcima	Četvrtasti priključak od 1/4": 4, 4,5, 5, 5,5, 6, 7, 8, 9, 10, 11, 12 i 13 1/4" Četvrtasti duboki priključak: 5, 6, 7, 8, 9, 10, 11, 12, 13 T umetak (25 mm): T8, T10, T15, T20, T25, T27, T30 i T40	84T ključ sa čegrtaljkom, adapter za futer od 1/4", klizna T drška, Produžna šipka: 75 mm, 150 mm		
B-65573	23-delni komplet ključa sa čegrtaljkom i priključcima	Četvrtasti priključak od 3/8": 8, 9, 10, 11, 12, 13, 14, 15, 16, 17, 18, 19 i 20 3/8" Četvrtasti srednje duboki priključak: 8, 10, 13, 16, 17, 19	84T ključ sa čegrtaljkom, adapter od 1/2", Produžna šipka: 75 mm, 150 mm		
B-65589	23-delni komplet ključa sa čegrtaljkom i priključcima	Četvrtasti priključak od 1/2": 10, 11, 12, 13, 14, 15, 16, 17, 18, 19, 20, 21, 22, 23, 24, 27, 30 i 32	84T ključ sa čegrtaljkom, adapter od 3/8", univerzalni zglobov, Produžna šipka: 125 mm, 250 mm		

## Nasadni ključevi



### Nasadni ključevi prolazni

Model	Veličina nasada	Ukupna dužina (mm)	Cena sa PDV-om
B-65648	10	32	
B-65654	11	32	
B-65660	12	32	
B-65676	13	32	
B-65682	14	32	
B-65698	15	32	
B-65707	16	32	
B-65713	17	32	
B-65729	18	32	
B-65735	19	32	

- Akumulat orni i punjači
- Pribor za akumulat orske alate
- Akumulat orske lampe i pribor
- Pribor za laserske merace
- Pribor za rušenje i udarno bušenje
- Pribor za bušenje
- Krunaste testere
- Pribor za pritzanje
- Pribor za sečenje i bušenje
- Pribor za bušenje i poliranje
- Pribor za profilisanje i poravnanje
- Pribor za višenamenski alat
- Pribor za testere
- Pribor za pneumat ske alate
- Pribor za fenove za vrući vazduh
- Pribor za usisivanje
- Pribor za alate za rad na otvoreno
- Pribor za držače alata i zaštitna
- Koferi i torbe
- Ručni alati
- Ostalo
- Pribor za mješanje



## Pribor



Tanji kraj alata olakšava korisnicima rad na tesnim prostorima. Mogućnost podešavanja ugla radne glave alata omogućava korisnicima rad na dubljim teško dostupnim mestima.

	Model	Naziv	Dužina (D) (mm)	Cena sa PDV-om
	B-65844	Adapter za priključak od 1/4	27	
	B-65850	Adapter za priključak od 3/8	32	
	B-65632	Produžna šipka za okasti ključ sa čegrtaljkom	75	
	B-65610	Ravna drška okastog ključa sa čegrtaljkom	205	
	B-65626	Podesiva drška okastog ključa sa čegrtaljkom	305	

## Kompleti

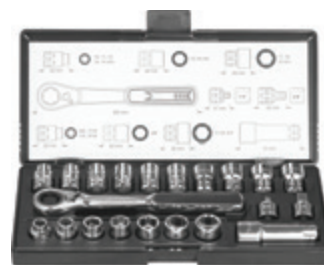
Mehanizam sa 72 zubača na okastoj strani alata. Rad pod uglom od 5°. Omogućava korisnicima rad na tesnim prostorima.



	Model	Naziv	Priključak (mm)	Pribor	Cena sa PDV-om
	B-65595	14-delni komplet prolaznih ključeva sa čegrtaljkom	10, 11, 12, 13, 14, 15, 16, 17, 18, 19	Adapter za priključak od 1/4", 3/8", produžna šipka za okasti ključ sa čegrtaljkom od 75 mm, drška ključa sa čegrtaljkom	
	B-65604	21-delni komplet prolaznih ključeva sa čegrtaljkom	10, 11, 12, 13, 14, 15, 16, 17, 18 i 19 Veličina priključaka u inčima: 3/8", 7/16", 1/2", 9/16", 5/8", 11/16" i 3/4"	Adapter za priključak od 1/4" i 3/8", produžna šipka za okasti ključ sa čegrtaljkom od 75 mm i drška ključa sa čegrtaljkom	

## Odvijači

### Ravni



Model	Naziv	Dužina (D) (mm)	Tip vijka	Tip	Cena sa PDV-om
B-66020	Odvijač	100	SL4	magnetni	
B-66036	Odvijač	100	SL5.5	magnetni	
E-04933	Odvijač s metalnom kapom SL5.5	75	SL5.5	magnetni	
B-66042	Odvijač	125	SL6.5	magnetni	
E-04949	Odvijač s metalnom kapom SL6.5	150	SL6.5	magnetni	
B-66058	Odvijač	150	SL8,0	magnetni	
E-04955	Odvijač s metalnom kapom SL8	200	SL8,0	magnetni	

### Torx



Model	Naziv	Dužina (D) (mm)	Tip vijka	Tip	Cena sa PDV-om
B-65975	Odvijač	100	T10	magnetni	
B-65981	Odvijač	100	T15	magnetni	
B-65997	Odvijač	100	T20	magnetni	
B-66008	Odvijač	100	T25	magnetni	
B-66014	Odvijač	100	T30	magnetni	

### Krst



Model	Naziv	Ukupna dužina (mm)	Tip vijka	Tip	Cena sa PDV-om
B-65903	Odvijač	100	PH1	magnetni	
B-66064	Odvijač s metalnom kapom PH1 (1X75)	75	PH1	magnetni	
B-65919	Odvijač	100	PH2	magnetni	
B-66070	Odvijač s metalnom kapom PH2 (2X100)	100	PH2	magnetni	
B-65931	Odvijač	150	PH3	magnetni	
B-66086	Odvijač s metalnom kapom PH3 (3X150)	150	PH3	magnetni	
B-65947	Odvijač	80	PZ1	magnetni	
B-66092	Odvijač s metalnom kapom PZ1 (1X75)	75	PZ1	magnetni	
B-65953	Odvijač	100	PZ2	magnetni	
B-66101	Odvijač s metalnom kapom PZ2 (2X100)	100	PZ2	magnetni	
B-65969	Odvijač	150	PZ3	magnetni	
B-66117	Odvijač s metalnom kapom PZ3 (3X150)	150	PZ3	magnetni	

Akumulat  
ori i  
punjači

Pribor za  
akumulat  
orske  
alate

Akumulat  
orske  
lampe i  
pribor

Pribor za  
laserske  
merace

Pribor za  
rušenje i  
udarno  
bušenje

Pribor za  
bušenje

Krunaste  
testere

Pribor za  
pritezanje  
e

Pribor za  
sečenje i  
brusjenje

Pribor za  
brusjenje  
i  
poliranje

Pribor za  
profilisanje  
e i  
poravnava

Pribor za  
višenam  
enski alat

Pribor za  
testere

Pribor za  
pneumat  
ske alate

Pribor za  
fenove  
za vrući  
vazduh

Pribor za  
usisivanje

Pribor za  
alate za  
rad na  
otvoreno

Pribor za  
držače  
alata i  
zaštitna

Koferi i  
torbe

Ručni  
alati

Ostalo

Pribor za  
mješanje



## Kompleti

	Model	Naziv	Ukupna dužina (mm)	Tip vijka	Tip	Cena sa PDV-om
	E-10528	Komplet odvijača 6 delni	100, PZ1 - 80	SL4, SL5.5, PH1, PH2, PZ1, PZ2	magnetni	
	E-10534	Komplet odvijača 5 delni	100	T10, T15, T20, T25, T30	magnetni	

- Akumulat  
ori i  
punjači
- Pribor za  
akumulat  
orske  
alate
- Akumulat  
orske  
lampe i  
pribor
- Pribor za  
lasevske  
merace
- Pribor za  
rušenje i  
udarno  
bušenje
- Pribor za  
bušenje
- Krunaste  
testere
- Pribor za  
pritezanje
- Pribor za  
sečenje i  
brusenje
- Pribor za  
brusenje  
i  
poliranje
- Pribor za  
profilisanje  
i  
poravnav
- Pribor za  
višenam  
enski alat
- Pribor za  
testere
- Pribor za  
pneumat  
ske alate
- Pribor za  
fenove  
za vrući  
vazduh
- Pribor za  
usisivanje
- Pribor za  
alate za  
rad na  
otvoreno
- Pribor za  
držače  
alata i  
zaštitna
- Koferi i  
torbe
- Ručni  
alati
- Ostalo
- Pribor za  
mješanje



## UDARNI ODVIJAČI



Odlično za uklanjanje oštećenih/ogoljenih vijaka koje električni alat ne može odvijati.

Primenom sile na dršku stvara se obrtni moment za rotaciju odvijača u smeru odvijanja.



12°



Model	Ukupna dužina	Vrsta vijaka
B-42438	125 mm	PH2
B-42444	150 mm	PH3
B-42450	125 mm	PZ2
B-42466	150 mm	PZ3

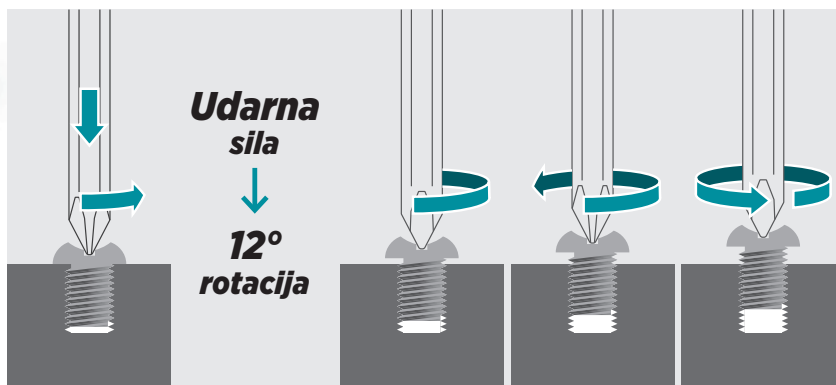

## MERNE TRAKE



### Sigurnost na prvom mestu!

Model B-57174 ima držač kaiša sa sigurnosnom sajlicom za veću sigurnost pri radu na visini.



Model	Dužina trake	Širina trake
E-03078	2 m	13 mm
B-57130	3,5 m	16 mm
B-57152	7,5 m	25 mm
B-57168	10 m	25 mm
B-57174	7,5 m	25 mm



### Izdržljiva kuka



gumirani odbojnik štiti kuku kada se uvlači u kućište



gumirani odbojnik štiti kuku u slučaju pada



kuka sa 4 zakovice + zaštitnik za robusniju kuku

### Specijalni premaz



5 puta otpornija traka







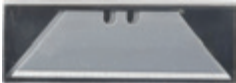

omogućava vam da olovkom pišete na traci

## Noževi



## Noževi

	Model	Naziv	Jedinica (kom/kompl)	Cena sa PDV-om
	B-65501	Višenamenski sklapajući nož	1	
	B-65517	Set zamenskih noževa	10/1	
	B-65785	Skalpel	1	
	D-58855	Skalpel	1	
	D-72914	Strugač za fuge	1	
	D-74734	Set zamenskih noževa	10/1	
	E-11520-12	Sklopivi nož sa izmjenjivim oštricama 12 kom	12/1	

- Akumulat
- Punjači
- Pribor za
- akumulat
- orske
- alate
- Akumulat
- orske
- lampe i
- pribor
- Pribor za
- laserske
- merace
- Pribor za
- rušenje i
- udarno
- bušenje
- Pribor za
- rušenje
- bušenje
- Krunaste
- testere
- Pribor za
- pritezanj
- e
- Pribor za
- sečenje i
- brusenje
- Pribor za
- brusenje
- i
- poliranje
- Pribor za
- profilisanj
- e i
- poravnaj
- Pribor za
- višenam
- enski alat
- Pribor za
- testere
- Pribor za
- pneumat
- iske alate
- Pribor za
- fenove
- za vrući
- vazduh
- Pribor za
- usisivanj
- e
- Pribor za
- alate za
- rad na
- otvoreno
- Pribor za
- držače
- alata i
- zaštitna
- Koferi i
- torbe
- Ručni
- alati
- Ostalo
- Pribor za
- mješanje

## Makaze za lim

### Makaze za lim

Pogodne za pocinkovani čelični lim i čelične U-profile. Drške koje ne klize izrađene od dva različita materijala. Snažna kovana sečiva izrađena od CrMoV čelika za veću snagu i izdržljivost u radu.



Model	Naziv	Pogodno za	Kapacitet sečenja (valjani/nerđajući čelik)	Cena sa PDV-om	
B-65791	Makaze za lim ravne	Ravno sečenje	18 ga (1,22 mm) / 23 ga (0,61 mm)		
B-65800	Makaze za lim leve	Ravno sečenje i sečenje ulevo	18 ga (1,22 mm) / 23 ga (0,61 mm)		
B-65816	Makaze za lim desne	Ravno sečenje i sečenje udesno	18 ga (1,22 mm) / 23 ga (0,61 mm)		
B-65822	Makaze za lim (dodatno ojačane)	Sečenje debelog materijala	16 ga (1,63 mm) / 18 ga (1,22 mm)		

## Metričke ureznice I nareznice

### Pribor



Model	Naziv	Cena sa PDV-om	
B-65838	40 delni set metričkih ureznica i nareznica		
B-65866	Držać prolaznog nasadnog ključa		
B-65872	Držać ureznice		
B-65888	Držać nareznice		

Akumulat  
ori i  
punjači

Pribor za  
akumulat  
orske  
alate

Akumulat  
orske  
lampe i  
pribor

Pribor za  
laserske  
merace

Pribor za  
rušenje i  
udarno  
bušenje

Pribor za  
bušenje

Krunaste  
testere

Pribor za  
pritezani  
e

Pribor za  
sečenje i  
brusenje

Pribor za  
brusenje  
i  
poliranje

Pribor za  
profilisanje  
e i  
poravnav

Pribor za  
višenam  
enski alat

Pribor za  
testere

Pribor za  
pneumat  
ske alate

Pribor za  
fenove  
za vrući  
vazduh

Pribor za  
usisivanj  
e

Pribor za  
alate za  
rad na  
otvoreno

Pribor za  
držače  
alata i  
zaštitna

Koferi i  
torbe

Ručni  
alati

Ostalo

Pribor za  
mješanje

# OSTALO

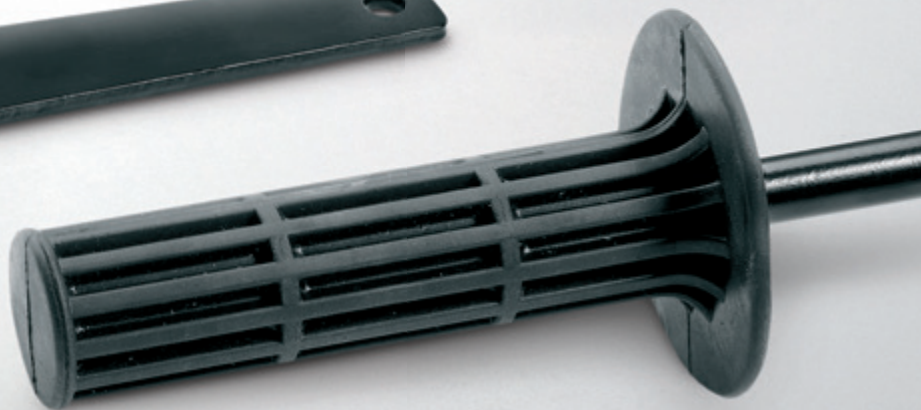

## Drške

### Drške

Model	Naziv	Za model	Cena sa PDV-om	
122575-0	Drška	BDF460, BHP460		
122711-8	Drška	8414D, 8434D, 8444D		
122712-6	Drška	BHR200, 6319D, 6339D, 6349D		
122727-3	Drška	TW1000		
122750-8	Drška	BHP451, DHP451, DHP441		
122C01-7	Drška	DHP486, HP001G		
123138-5	Bočna drška	DHR400, HR005G, HR4003C, HR4013C		
123167-8	Drška	BDF451		
123257-7	Drška	HP458D		
125779-3	Drška	BO5041		
126413-8	Drška	DHP481		
127551-9	Drška	HP001G		
134881-1	Drška	HR5001C		
134887-9	Bočna drška D-tip	HR5000, HR5000K		

Nastavak...

Akumulat  
ori i  
punjači

Pribor za  
akumulat  
orske  
alate

Akumulat  
orske  
lampe i  
pribor

Pribor za  
laserske  
merace

Pribor za  
rušenje i  
udarno  
bušenje

Pribor za  
bušenje

Krunaste  
testere

Pribor za  
pritezanje

Pribor za  
sečenje i  
brusjenje

Pribor za  
brusjenje  
i  
poliranje

Pribor za  
profilisanje  
i  
poravnanje

Pribor za  
višenam  
enski alat

Pribor za  
testere

Pribor za  
pneumat  
ske alate

Pribor za  
fenove  
za vrući  
vazduh

Pribor za  
usisivanje

Pribor za  
alate za  
rad na  
otvoreno

Pribor za  
držače  
alata i  
zaštitna

Koferi i  
torbe

Ručni  
alati

Ostalo

Pribor za  
mješanje

	Model	Naziv	Za model	Cena sa PDV-om
	134889-5	Drška	HR3000C	
	134890-0	Bočna drška	HM1111C, HM1101C, HR3540C, HR3541FC, HR4001C, HR4002 HR4010C, HR4011C, HR4040C, HR4501C, HR4510C, HR4511C	
	134903-7	Drška	DP3003	
	134909-5	Bočna drška	HM1100, HM1100C, HM1200, HM1200B, HM1130, HM1130C, HM1140C, HM1211B HM0870C, HM0871C	
	134910-0	Drška	DP4003	
	134915-0	Bočna drška	HR4500C	
	134945-1	Bočna drška D-tip	HR5001C	
	135197-7	Drška	HR3200C, HR3210C, HR3210CCT	
	135209-6	Drška	HR3540C, HR3541FC, HR4001C, HR4010C, HR4011C, HR4501C, HR4510C, HR4511C	
	135269-8	Drška D-tip	HM1202C, HM1242C, HR5201C, HR5210C, HR5211C	
	135283-4	Bočna drška	HM1214C, HR5212C, HR006G	
	135302-6	Drška	HR2021, HR2022, HR2432, HR2441, HR2445, HR2451, HR2452, HR2453, HR2454, HR2455	
	135332-7	Bočna drška	HM0870C, HM0871C, HM001G	
	135380-6	Drška	HR5201C, HR5210C, HR5211C	

[Nastavak...](#)

Model	Naziv	Za model	Cena sa PDV-om	
135629-4	Bočni rukohvat	HR006G, HR5202C, HR5212C		
140G50-6	Drška	DUT130		
140X75-2	Bočna drška	DPV300, PV301D		
140Y64-3	Drška	RS002G		
151776-3	Drška	9077SL		
151949-8	Drška	6300-4		
151965-0	Drška	6300-4, 6013BR, 6300NB, 6016, DP4700		
152492-0	Drška	6300-4, 6013BR, 6300NB, 6016, DP4700		
152539-0	Drška	PK5011C		
152612-6	Drška	5901B		
153489-2	Drška	MT952, MT953, 9554NB, PW5000CH, GA5080R, DGA520, DGA521, RT0702C		
154935-8	Drška	BDF444RFE, BDF454RFE		
158057-6	Drška	BHR202, BHR242, BHR243, BHR261, BHR262, HP1230, HR1830, HR1830F, HR1830FT, HR2230, HR2460, HR2460F, HR2470, HR2470F, HR2470T, HR2470FT, HR2475, HR2800, HR2810, HR2810FT, HR2811FT		
158131-0	Drška	HM0830, HM0870C, HM0871C, HR3000C, HR3530, HR3540C, HR3541FC, HR4000C, HR4001C, HR4002, HR4010C, HR4011C, HR4030C, HR4041C, HR4500C, HR4501C, HR4510C, HR4511C, HR5001C, HR5201C, HR5210C, HR5211C		
158237-4	Drška	DGA504, DDA450, GA5051R		

Nastavak...

Akumulat  
ori i  
punjači

Pribor za  
akumulat  
orske  
alate

Akumulat  
orske  
lampe i  
pribor

Pribor za  
laserske  
merace

Pribor za  
rušenje i  
udarno  
bušenje

Pribor za  
bušenje

Krunaste  
testere

Pribor za  
pritezani  
e

Pribor za  
sečenje i  
brusenje

Pribor za  
brusenje  
i  
poliranje

Pribor za  
profilisanj  
e i  
poravnaj

Pribor za  
višenam  
enski alat

Pribor za  
testere

Pribor za  
pneumat  
ske alate

Pribor za  
fenove  
za vrući  
vazduh

Pribor za  
usisivanj  
e

Pribor za  
alate za  
rad na  
otvoreno















Pribor za  
držače  
alata i  
zaštitna

Koferi i  
torbe

Ručni  
alati



Ostalo

Pribor za  
mješanje

	Model	Naziv	Za model	Cena sa PDV-om
	162264-5	Anti vibraciona drška	GA9040S	
	163506-0	Bočna drška	HM1317CB	
	191D07-2	Drška	DHR171, DHR182, HR140D, HR166D, HR1840	
	191E41-8	Bočna drška	DDF484, DF002G, DHP484, HP002G	
	192258-6	Drška	9069, 9059	
	194514-0	Anti vibraciona drška	GA5010, CA5011, GA5020, GA5021, GA5021C, GA6010, CA6011, GA6020, GA6020C, GA6021, GA6021C, GA5050R, GA4550R, DGA520, DGA521	
	194684-5	Anti vibraciona drška	GA7020, GA7020S, GA7030, GA7030S, GA7040S, GA9020, GA9020S, GA9030, GA9030S, GA9041S	
	196792-8	Bočna drška	DHR400, HR4003C, HR4013C, HR005G	
	199176-9	Drška	GA7062, GA9060, GA9062	
	273404-1	Drška	6013BR-T17273404-1	
	273423-7	Drška	HM1400	
	273495-2	Drška	LS1030, LS800DWA	
	416256-9	Kružna drška	9227C, PC5000C	
	416348-4	Kružna drška	9227CB	

[Nastavak...](#)



Model	Naziv	Za model	Cena sa PDV-om	
419792-4	Osnova bočne drške	HR5210C, HR5211C		
6254502100	Drška	RBC261		
XNR0000304	Kružna drška	EBH341		





## Ključevi

### Nasadni ključevi sa ispustima



Model	Naziv	Veličina	Za model	Cena sa PDV-om
782401-1	Nasadni ključ sa ispustima	20 mm	PJ7000, 3901, BPJ180, DPJ180	
782412-6	Nasadni ključ sa ispustima	28 mm	9207, 9217, GV7000	
197610-3	Nasadni ključ sa ispustima	35 mm	GA9010, GA9020, GA9030, GA9040, GA7010, GA7020, GA7030, GA7040, GA5040, GA4540	
782423-1	Nasadni ključ sa ispustima	35 mm	GA6021, GA6021C, 9558, 9557	
782426-5	Nasadni ključ sa ispustima	35 mm	PC5000, PC5001	

### Nasadni ključevi

Model	Naziv	Veličina	Za model	Cena sa PDV-om	
782203-5	Nasadni ključ	SW9	2012NB		
782209-3	Nasadni ključ	SW9	1902, 1911B, 1923H, 4101R, 4105KB, BKP180, KP0800, KP0810, KP0810C		
782210-8	Nasadni ključ	SW17	2414NB, 4112HS, AT3624, BBC231U, BC231UD, LC1230		
782212-4	Nasadni ključ	SW13	LH1040, LH1040F, LS1040, LS1040F, LS1013, LS1013F, LS1013L, LS1214, LS1214F, LS1214L, LS1440		
JM27000087	Ključ	SW25	MLT100X		

Akumulat  
ori i  
punjači

Pribor za  
akumulat  
orske  
alate

Akumulat  
orske  
lampe i  
pribor

Pribor za  
laserske  
merace

Pribor za  
rušenje i  
udarno  
bušenje

Pribor za  
bušenje

Krunaste  
testere

Pribor za  
pritezani  
e

Pribor za  
sečenje i  
brusenje

Pribor za  
brusenje  
i  
poliranje

Pribor za  
profilisanje  
i  
poravnava

Pribor za  
višenam  
enski alat

Pribor za  
testere

Pribor za  
pneumat  
ske alate

Pribor za  
fenove  
za vrući  
vazduh

Pribor za  
usisivani  
e

Pribor za  
alate za  
rad na  
otvoreno

Pribor za  
držače  
alata i  
zaštitna

Koferi i  
torbe

Ručni  
alati

Ostalo

Pribor za  
mješanje

# PRIBOR ZA MEŠANJE



## Mešači za miksere

Opremljeni zaštitnim prstenom na vrhu mešača za sprečavanje oštećenja posude tokom mešanja. Mešači za miksere za tečne materijale, materijale koji se brzo suše i viskozne materijale.



Šifra	Tip prihvata alata	Materijal	Prečnik	Dužina	Smer mešanja	Kapacitet mešanja	Broj obrtaja
D-73508	M14	Tečnosti	120 mm	600 mm	▼	15 kg	1.300 min <sup>-1</sup>
D-73514	M14	Viskozni materijali	120 mm	600 mm	▲	20 kg	590 min <sup>-1</sup>
D-73520	M14	Tečnosti koje se brzo suše	120 mm	600 mm	▼	18 kg	1.300 min <sup>-1</sup>
D-73536	3/8" hex	Tečnosti	120 mm	600 mm	▼	15 kg	1.300 min <sup>-1</sup>
D-73542	3/8" hex	Viskozni materijali	120 mm	600 mm	▲	20 kg	500 min <sup>-1</sup>

Šifra	D-73508	D-73536	D-73520	D-73514	D-73542
<b>Tip mešača za mešanje</b>	2 peraja – tečnosti		3 peraja – tečnosti koje se brzo suše	2 peraja – viskozni materijali	
<b>Slika mešača za mešanje</b>					
<b>Proces mešanja</b>					
<b>Odlike</b>	Mešanje materijala odozgo nadole.		Mešanje materijala odozgo nadole.	Mešanje materijala odozdo nagore.	
<b>Materijal koji se meša</b>	Koristi se za mešanje standardnih tečnih materijala. Usled toga što se materijal meša odozgo nadole, otežano je prskanje materijala pri velikim brzinama mešanja.		Usled toga što se materijal meša odozgo nadole, otežano je prskanje materijala pri velikim brzinama mešanja. Pored toga, mešač sa 3 peraja je izuzetno efikasan čime se skraćuje vreme mešanja. Stoga, podesan je za mešanje tečnih materijala koji se brzo suše.	Usled toga što se materijal meša odozdo nagore, sprečava se prskanje teških čvrstih materijala. Ex Mortar je mešavina cementa, peska i vode kod koje postoji tendencija da se pesak, kao najteži element mešavine, taloži na dnu. Usled toga što se materijal meša pri vrhu omogućeno je delotvorno mešanje ovakih materijala.	
<b>Najveća težina materijala</b>	15 kg		18 kg	20 kg	
<b>Najveća brzina sa opterećenjem</b>	1.300 min <sup>-1</sup>		1.300 min <sup>-1</sup>	590 min <sup>-1</sup>	500 min <sup>-1</sup>
<b>Tečnosti</b>	Zidne boje	✓	✓	✗	
	Disperzije	✓	✓	✗	
	Premazi	✓✓	✗	✗	
	Lakovi	✓✓	✗	✗	
	Emulzione boje	✓✓	✗	✗	
	Epoksidna smola	✓✓	✗	✗	
	Gipsani malter	✗	✓✓	✗	
<b>Viskozni materijali</b>	Lepak	✗	✗	✓✓	
	Cementni malter	✗	✗	✓✓	
	Malter	✗	✗	✓✓	
	Gips	✗	✗	✓✓	

✓ Dobro ✓✓ Odlično ✗ Nije preporučljivo

Akumulat orni i punjači  
 Pribor za akumulat orske alat  
 Akumulat orske lampe i pribor  
 Pribor za laserske merace  
 Pribor za rušenje i udarno bušenje  
 Pribor za bušenje  
 Krunaste testere  
 Pribor za pritezanje  
 Pribor za sečenje i brušenje  
 Pribor za brušenje i poliranje  
 Pribor za profilisanje i poravnanje  
 Pribor za višenamenski alat  
 Pribor za testere  
 Pribor za pneumatske alat  
 Pribor za fenove za vrući vazduh  
 Pribor za usisivanje  
 Pribor za alat za rad na otvoreno  
 Pribor za držače alata i zaštitna  
 Koferi i torbe  
 Ručni alati  
 Ostalo  
 Pribor za mješanje

## Mešala i pribor

Mešala za boje od nerdjajućeg čelika. Oblik lopatica obezbeđuje brz i uravnoteženi rezultat mešanja. lopatice idealno odgovaraju za mešanje tečnosti emulzionih boja i lakova.



A-43670



A-43686



A-43692

Listovi za mešanje					Šraf	
Model	Prečnik	Material	Kapacitet mešanja	Maksimalni br. Obrtaja	Model	Dimenzija
A-43670	130 mm	Boje na osnovu rastvarača, boje za zidove, lakovi, epoksi smole	5-15 kg	1.300 min <sup>-1</sup>	265220-5	M8 x 18
A-43686	150 mm	Boje za zidove, lakovi, epoksi smole	15 kg	1.300 min <sup>-1</sup>	vijak i matica priloženi	M8 x 25
A-43692	165 mm	Boje za zidove, lakovi, epoksi smole	10-20 kg	1.300 min <sup>-1</sup>	265220-5	M8 x 18



Vreteno		
Model	Navoj vratila	Dužina
168349-5	M12	550 mm
168884-3	M14	

Adapter za vreteno		
Model	Prihvatale alata	Prihvatale vratila
323962-8	1/2" - 20 UNF	M12
P-22062	1/2" - 20 UNF	M14
324929-9	5/8" - 16 UNF	M14
P-02325	5/8" - 16 UNF	M14



Akumulat orni punjači  
 Pribor za akumulat orske alate  
 Akumulat orske lampe i pribor  
 Pribor za laserske merace  
 Pribor za rušenje i udarno bušenje  
 Pribor za bušenje  
 Krunaste testere  
 Pribor za pritezanje  
 Pribor za sečenje i brušenje  
 Pribor za brušenje i poliranje  
 Pribor za profilisanje i poravnavanje  
 Pribor za višenamenski alat  
 Pribor za testere  
 Pribor za pneumatske alate  
 Pribor za fenove za vrući vazduh  
 Pribor za usisivanje  
 Pribor za alate za rad na otvoreno  
 Pribor za držače alata i zaštitna  
 Koferi i torbe  
 Ručni alati  
 Ostalo  
 Pribor za mešanje





**GARTNER RETAIL GROUP DOO**

Nemanjina 20 34000 Kragujevac

034/6101443 064/8661097

info@gartner.rs www.gartner.rs